

Please note for bespoke sizes please contact our Design Team on +44 (0) 2392 796633

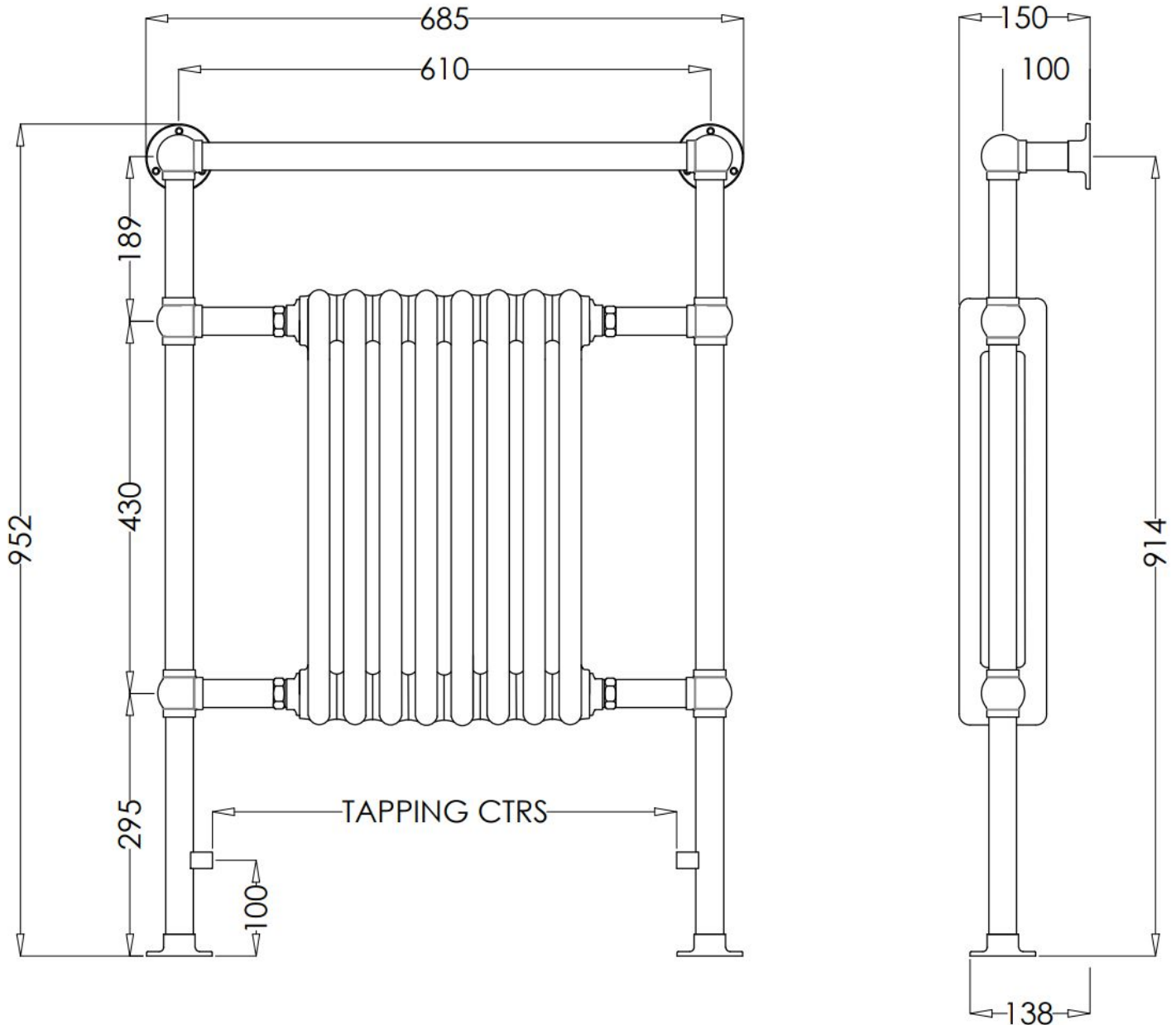

Dimensions.	Centres.	Tapping ctrs.	BTU's.	Wattage.
685mm	610mm	538mm	1850	545

Test Pressure: 8 bar.
Max. Working Pressure: 5 bar.
Max. Working Temperature: 85°C.
Material: 32mm DZR Brass.
Connections: ½" BSP.
Joints: Hand Brazed Silver Solder.
Finish: Hand Polished.
Plated To: British Standards.
Leak Tested: 3 Times.
Heat Output: In accordance with EN442.

To be installed by a suitably qualified professional in accordance with local water byelaws.
 Our Towel Warmers are suitable for:
 Most Central Heating Systems.
 Hot Water Systems. **(unsuitable for use with column radiator inserts)**
 Dual Fuel Systems.
 Electric only.
Please confirm with your installer/contractor that there is not a water softener fitted on the system prior to installation.
All dimensions are subject to +/- 3 mm tolerance.