

Please note for bespoke sizes please contact our Design Team on +44 (0) 2392 796633

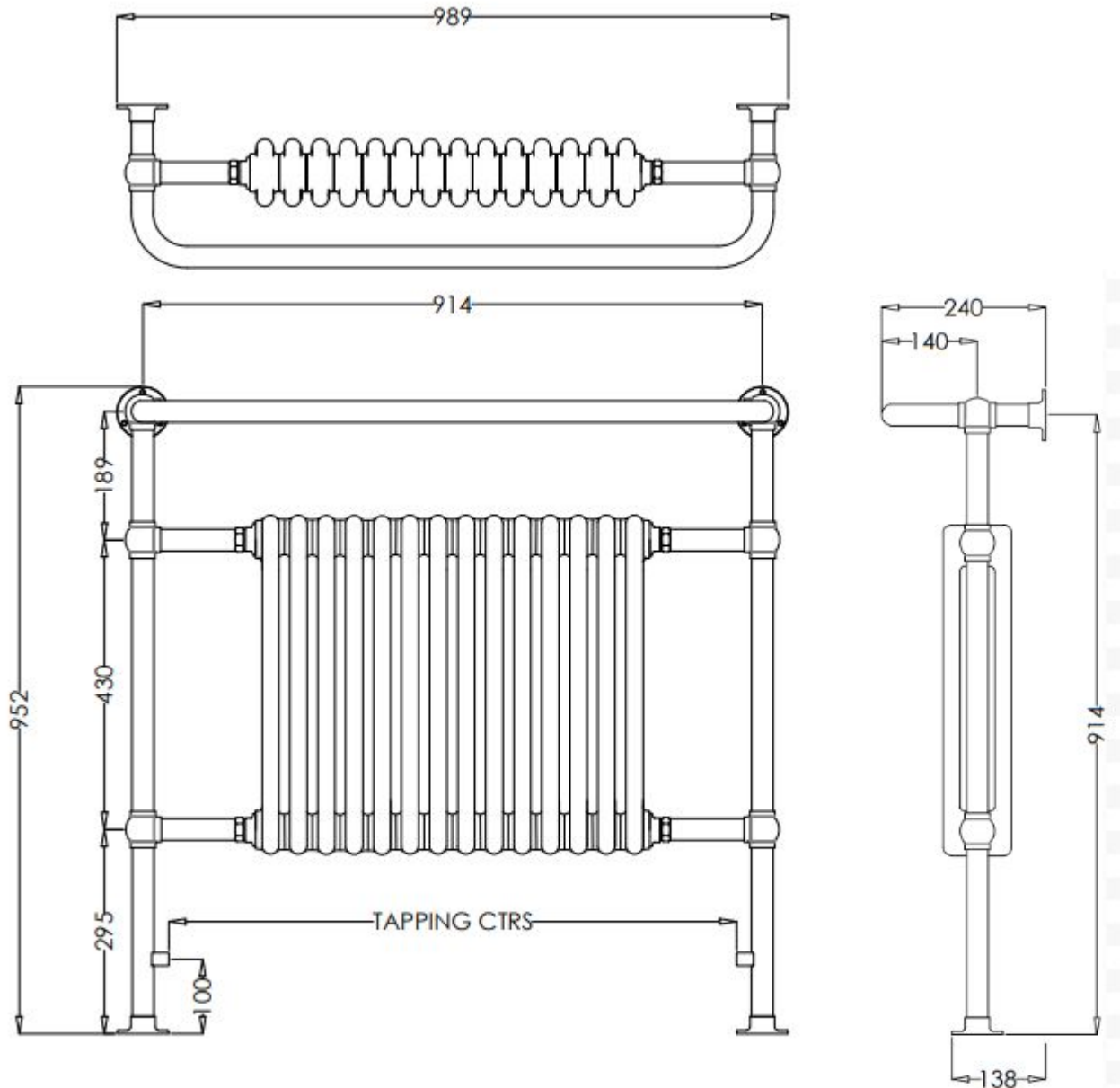

Dimensions.	Tapping Ctrs.	BTU's.	Wattage.
989mm	842mm	3016	884

**Test Pressure:** 8 bar.  
**Max. Working Pressure:** 5 bar.  
**Max. Working Temperature:** 85°C.  
**Material:** 32mm DZR Brass.  
**Connections:** ½" BSP.  
**Joints:** Hand Brazed Silver Solder.  
**Finish:** Hand Polished.  
**Plated To:** British Standards.  
**Leak Tested:** 3 Times.  
**Heat Output:** In accordance with EN442.

To be installed by a suitably qualified professional in accordance with local water byelaws.  
 Our Towel Warmers are suitable for:  
 Most Central Heating Systems.  
 Hot Water Systems. **(unsuitable for use with column radiator inserts)**  
 Dual Fuel Systems.  
 Electric only.  
**Please confirm with your installer/contractor that there is not a water softener fitted on the system prior to installation.**  
**All dimensions are subject to +/- 3 mm tolerance.**