

# Light My Bricks: LEGO Ford Mustang 10265 Lighting Kit



The following page is the instructions for the **Light My Bricks LEGO Ford Mustang (10265) LED light kit**.

If you run into any issues, please refer to the **online troubleshooting guide**.

To ensure a trouble-free installation of your light kit, please read and follow each step carefully. These instructions can be downloaded in PDF format **here**

*Please note: This page lists instructions for the LED light kit only. If you are wishing to purchase the Light My Bricks LEGO Ford Mustang (10265) LED light kit , please click here to view the product page*

---

## Package Contents:

- 7x White 30cm Bit Lights
- 8x White 15cm Bit Lights
- 1x 8-Port Expansion Board
- 1x 12-Port Expansion Board
- 1x NC Push Board
- 1x 15cm Connecting Cable
- 1x 30cm Connecting Cable
- 1x Flat Battery Pack (requires 2x CR2032 Batteries)

## LEGO Pieces:

- 6x Trans Clear Round Plate 1x1
- 1x Trans Clear Plate w Rounded Bottom 2x2

---

## Important things to note:

### Laying cables in between and underneath bricks

Cables can fit in between and underneath LEGO® bricks, plates, and tiles providing they are laid correctly between the LEGO® studs. Do NOT forcefully join LEGO® together around cables; instead ensure they are laying comfortably in between each stud.

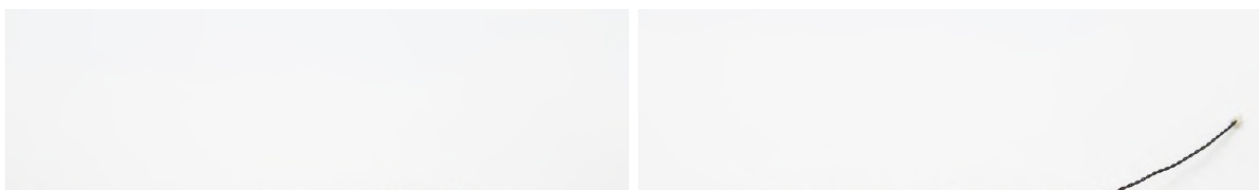

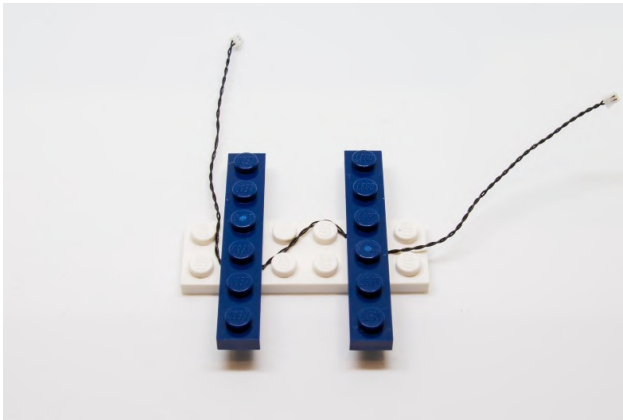

**CAUTION:** Forcing LEGO® to connect over a cable can result in damaging the cable and light.

## Connecting cable connectors to Expansion Boards

Take extra care when inserting connectors to ports of Expansion Boards. Connectors can be inserted only one way. With the expansion board facing up, look for the soldered “=” symbol on the left side of the port. The connector side with the wires exposed should be facing toward the soldered “=” symbol as you insert into the port. If a plug won't fit easily into a port connector, do not force it.

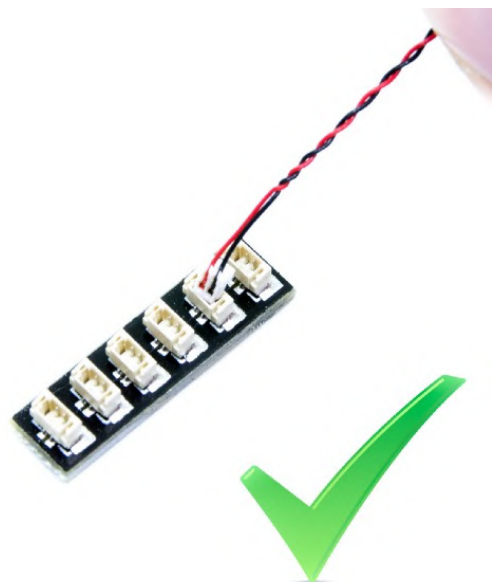

*Incorrectly inserting the connector can result in bent pins inside the port or possible overheating of the expansion board when connected.*

## Connecting cable connectors to Strip Lights

Take extra care when inserting connectors to ports on the Strip Lights. Connectors can be inserted only one way. With the Strip Light facing up, ensure the side of the connector with the wires exposed is facing down. If a plug won't fit easily into a port connector, don't force it. Doing so will damage the plug and the connector.

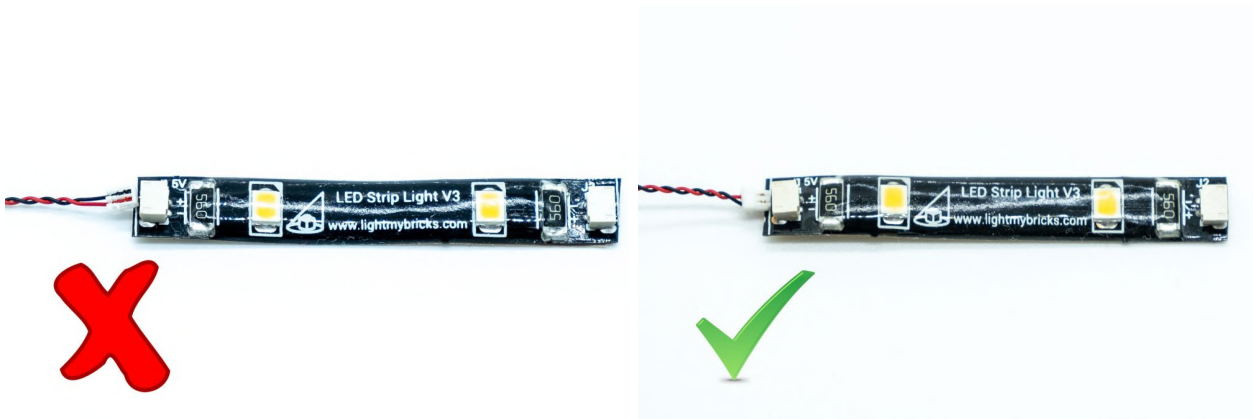

## Installing Bit Lights under LEGO® bricks and plates.

When installing Bit Lights under LEGO® pieces, ensure they are placed the correct way up (Yellow LED component exposed). You can either place them directly on top of LEGO® studs or in between.





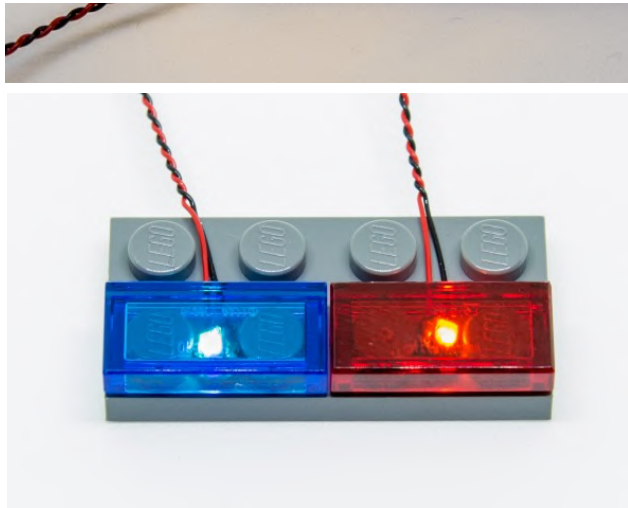
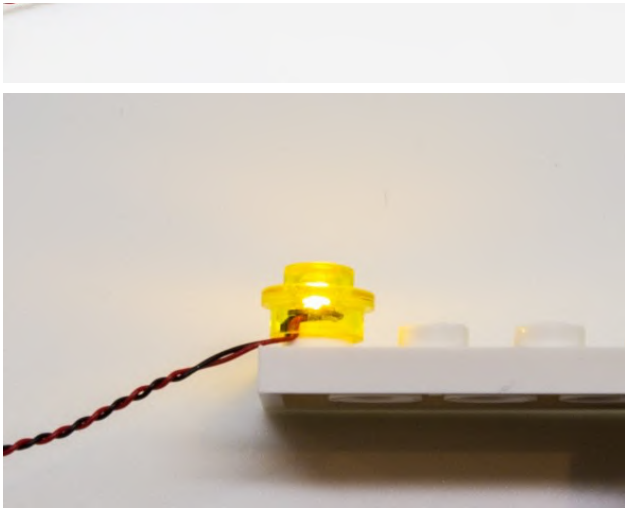

## OK, Let's Begin!

1.) We will start by installing lights to the front of the car. First disconnect the following sections surrounding the front of the vehicle as shown below:

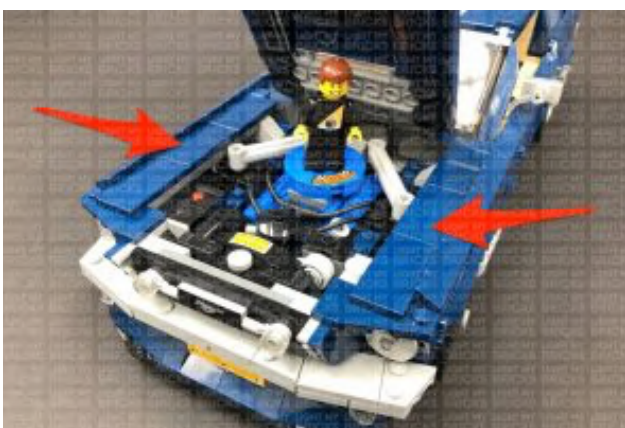



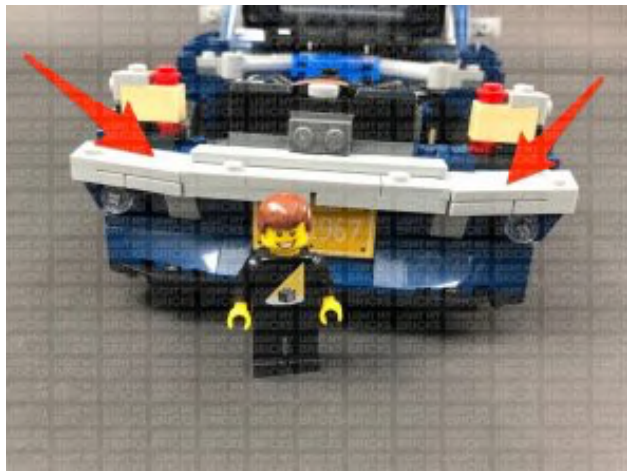
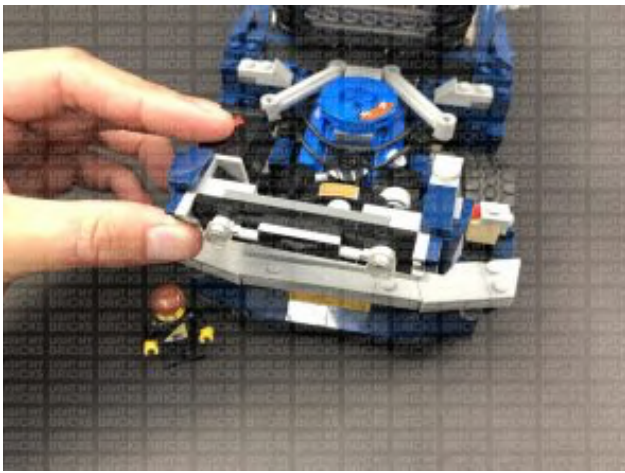
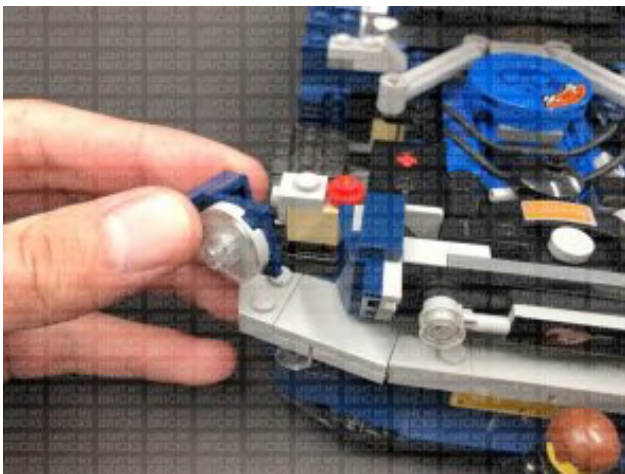
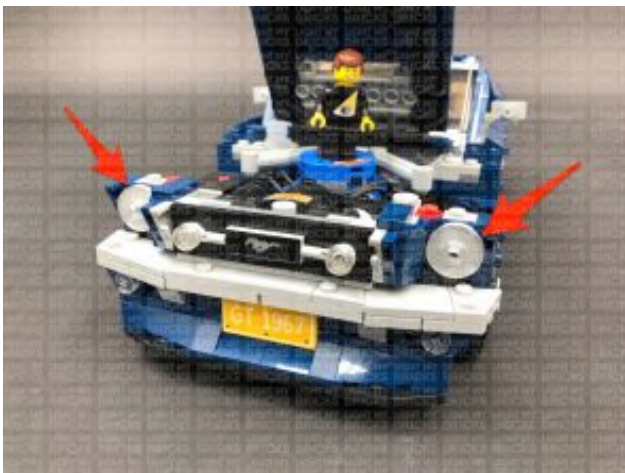



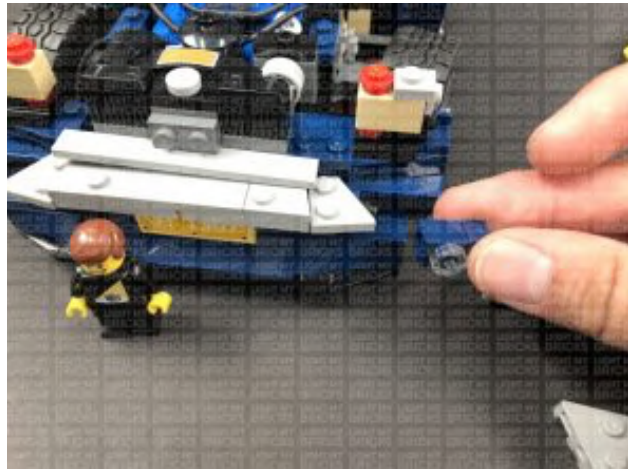
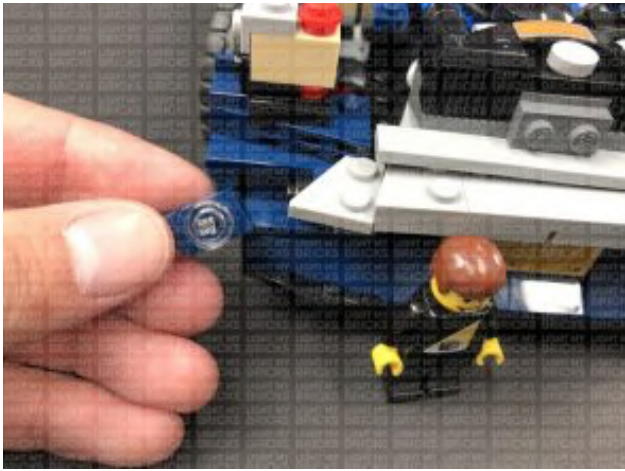
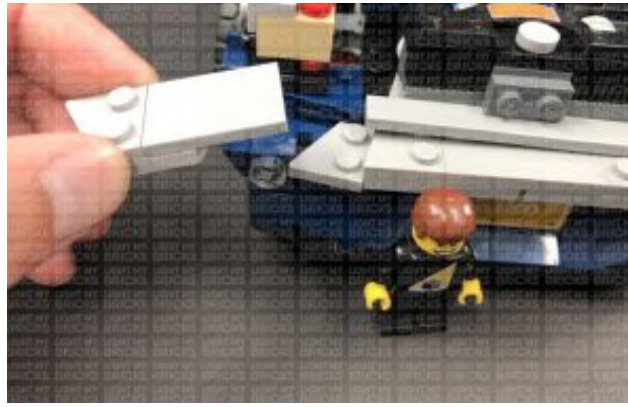
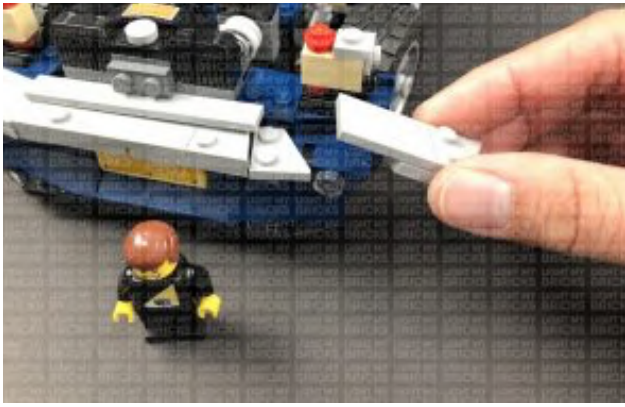

2.) Take the following two light sections and disconnect and discard the trans clear round tiles from them. Take a **White 30cm Bit Light** and thread the connector end of it through the front hole of one of the blue bricks. Thread it all the way through, then carefully bend the LED component so that it sits flat against the edge of the brick. Secure it in place by connecting a provided **Trans Clear Round Plate 1x1** over the top.



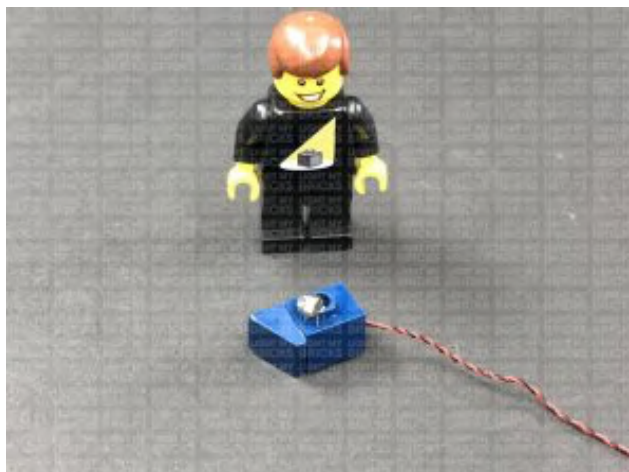
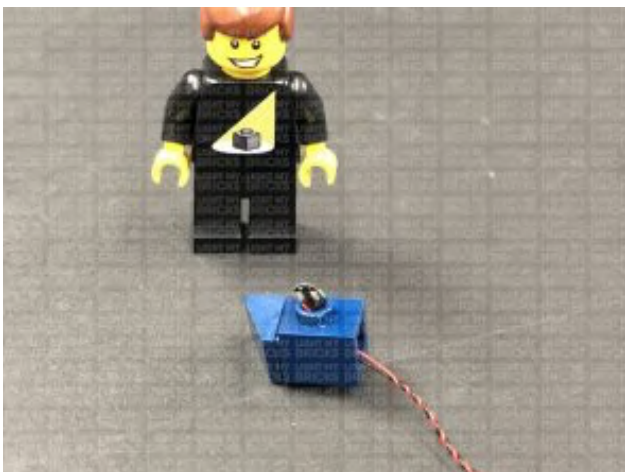
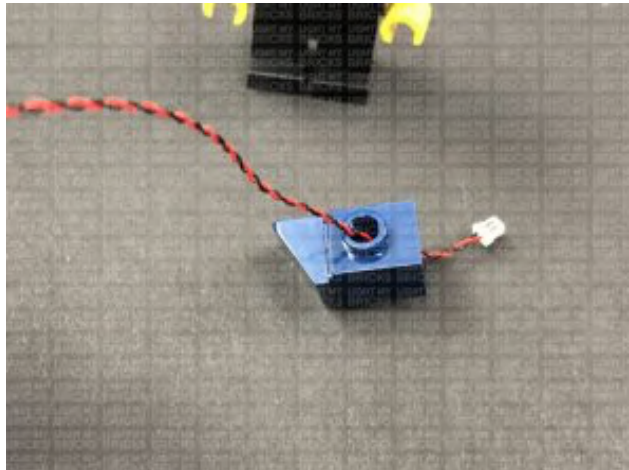
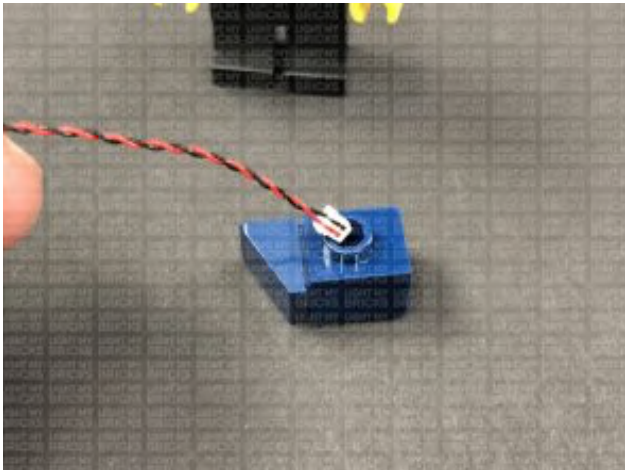
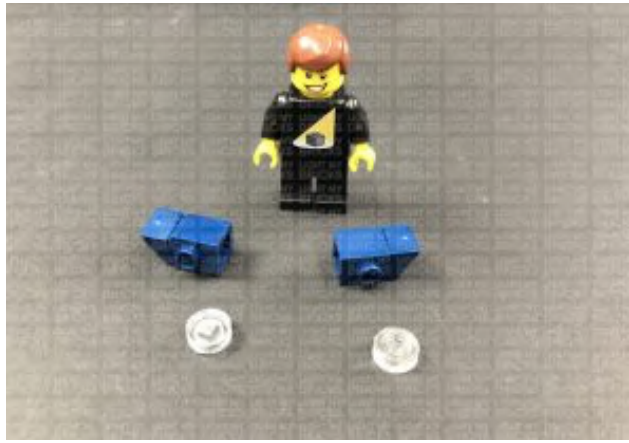
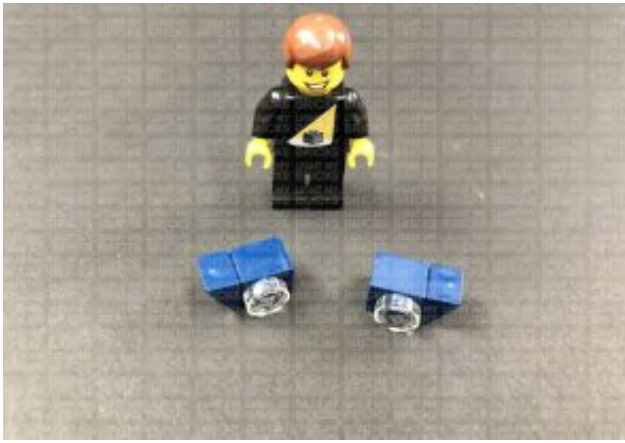



Repeat this process to install another **White 30cm Bit Light** to the other light section, securing it in place with another provided **Trans Clear Round Plate 1x1**. Reconnect these two sections back to the front of the car.

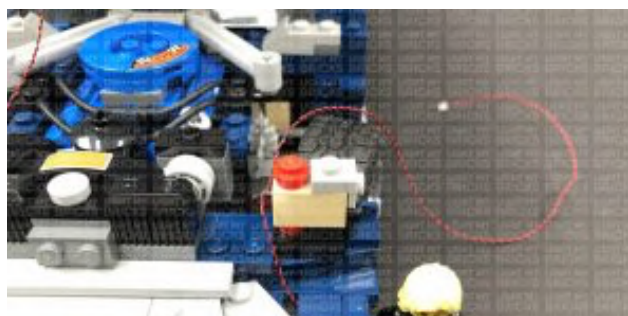
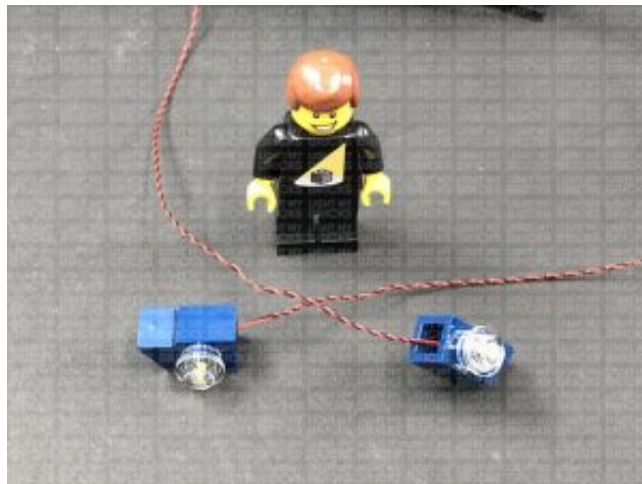
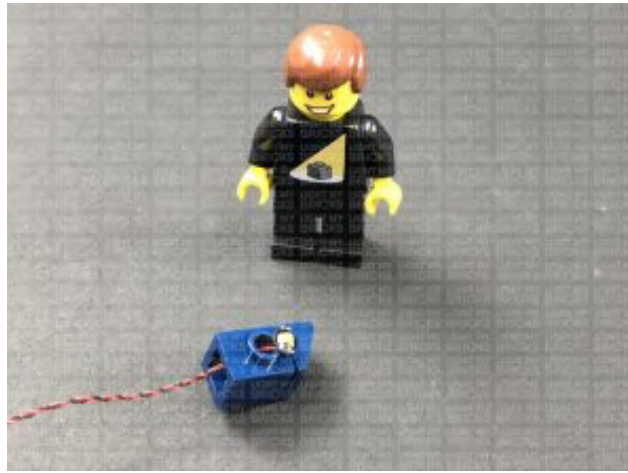
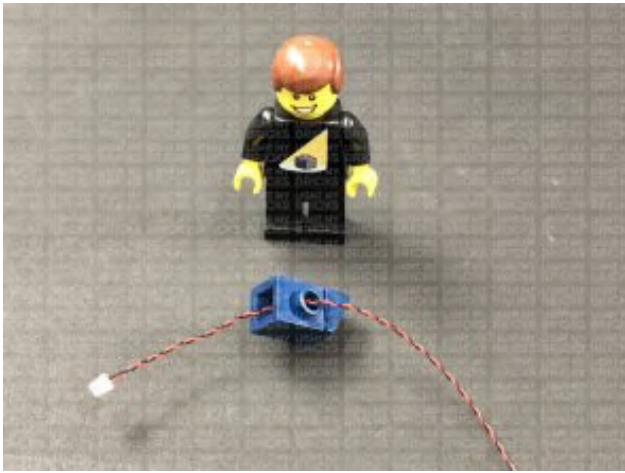



3.) Reconnect the following sections to each side of the front of the car, ensuring you cables are laid behind and in between pieces as shown below

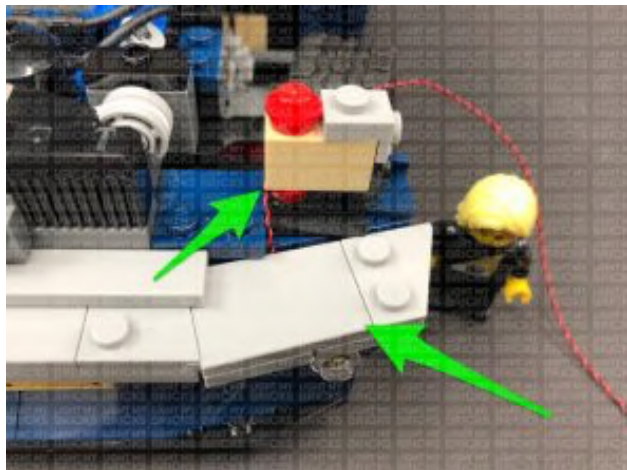
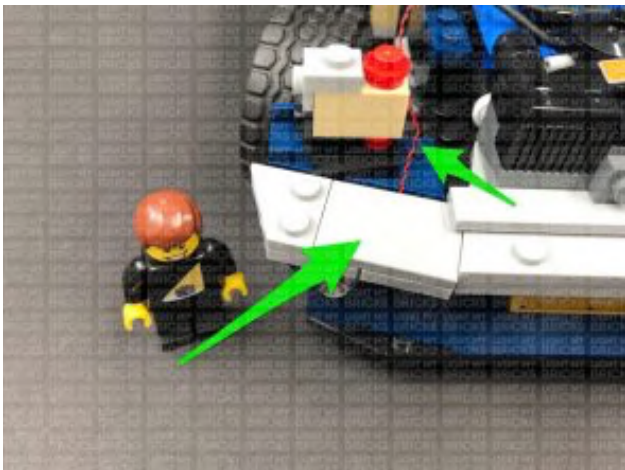

4.) Take the front grill and disconnect the centre section, then disconnect and discard the two trans clear round tiles.





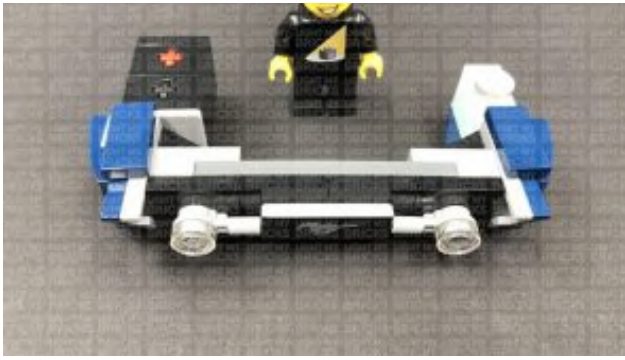

Take a **White 30cm Bit Light** and with the cable facing down, place it directly over the grey stud on the left. Secure the light in place by connecting a provided **Trans Clear Round Plate 1×1** over the top.

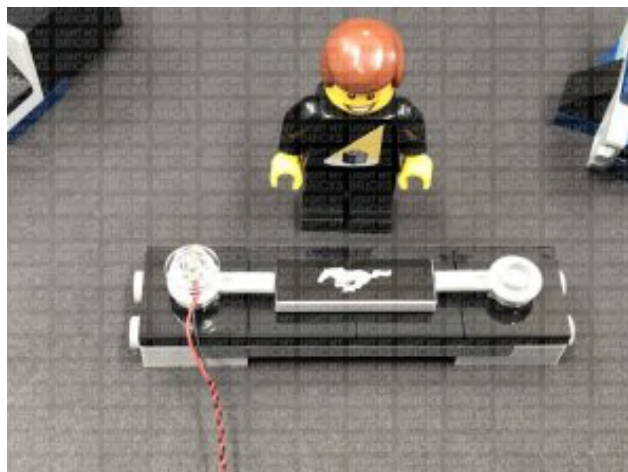
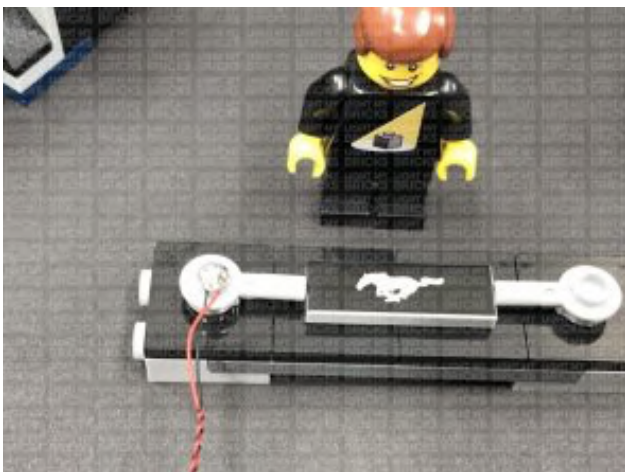

Repeat this process to install another **White 30cm Bit Light** to the other side of this section, securing it in place by connecting another provided **Trans Clear Round Plate 1×1** over the top. Turn this section over, then with the cables facing behind, reconnect it back to the front of the car.

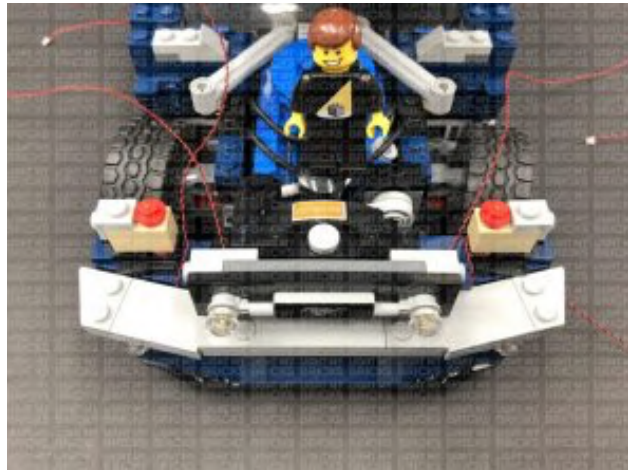
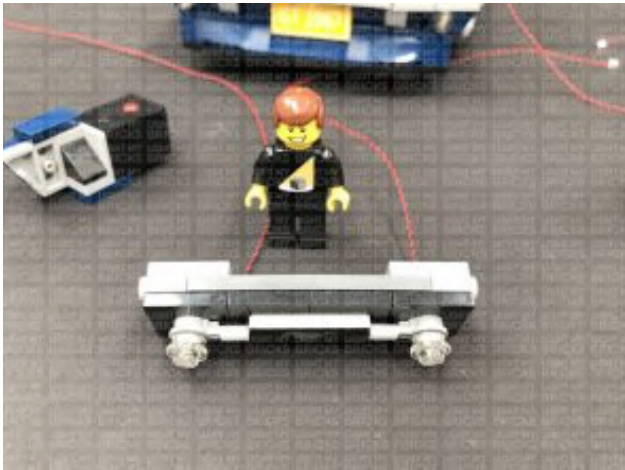
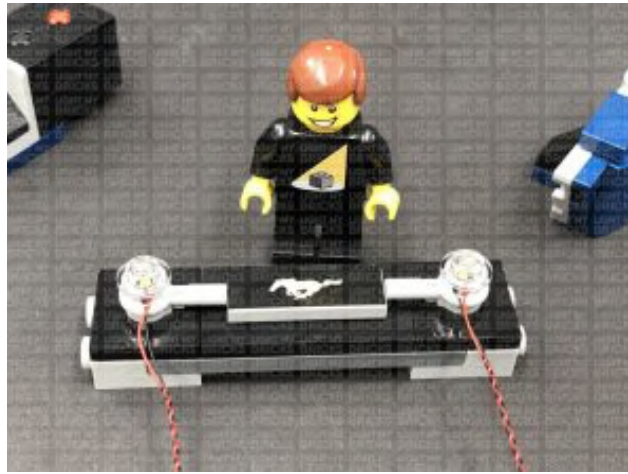
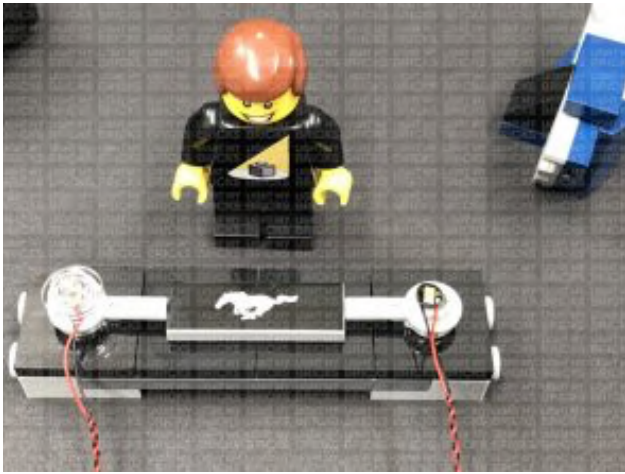

Reconnect the following two sections we removed from each side of the grill, ensuring cables are neatly laid in between studs and pieces.

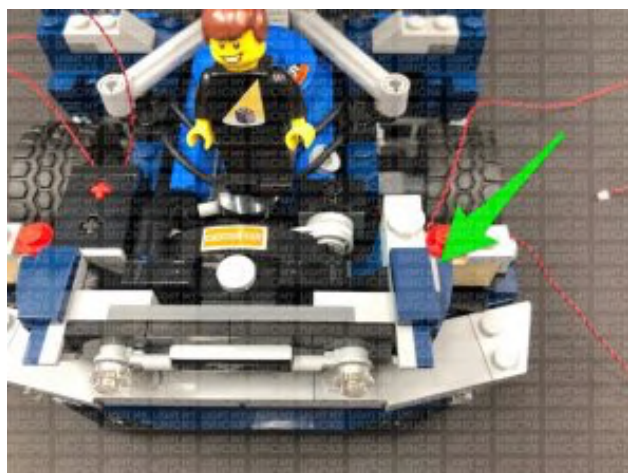
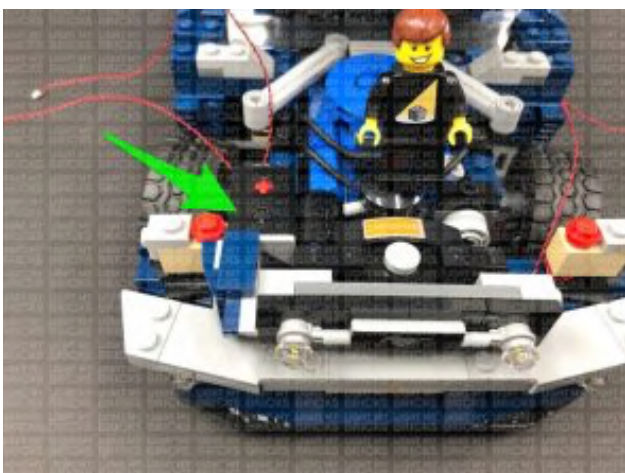



5.) Take the headlight sections and disassemble them as shown below:

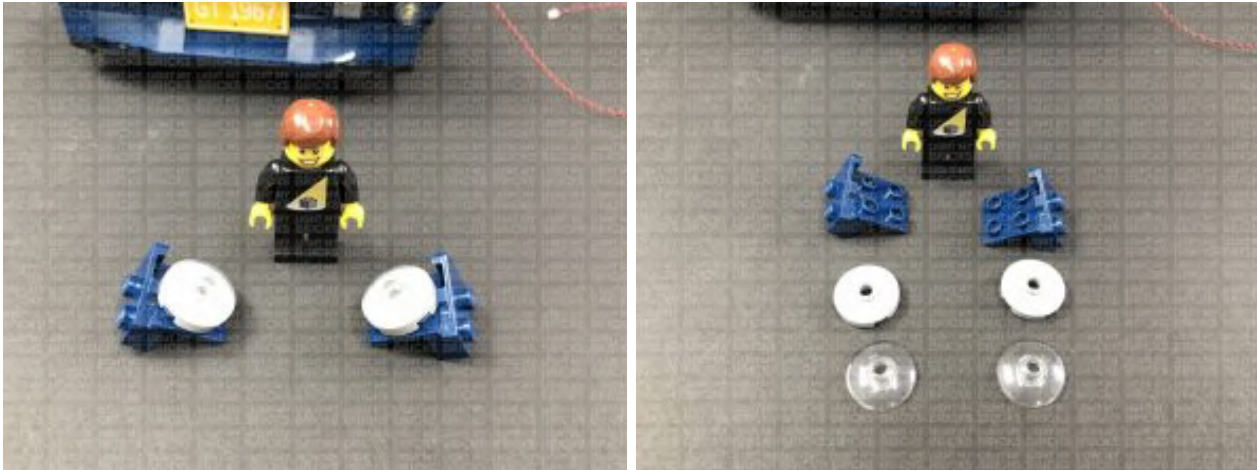

Take a **White 30cm Bit Light** and thread the connector end of the cable through the front of one of the light grey round pieces. Thread it all the way through, then carefully bend the LED component so that it sits flat against the front of the light grey piece. Secure the Bit Light in place by reconnecting the trans clear 2x2 dish over the top, then reconnect this to left blue section ensuring the cable is facing the inside as shown below:

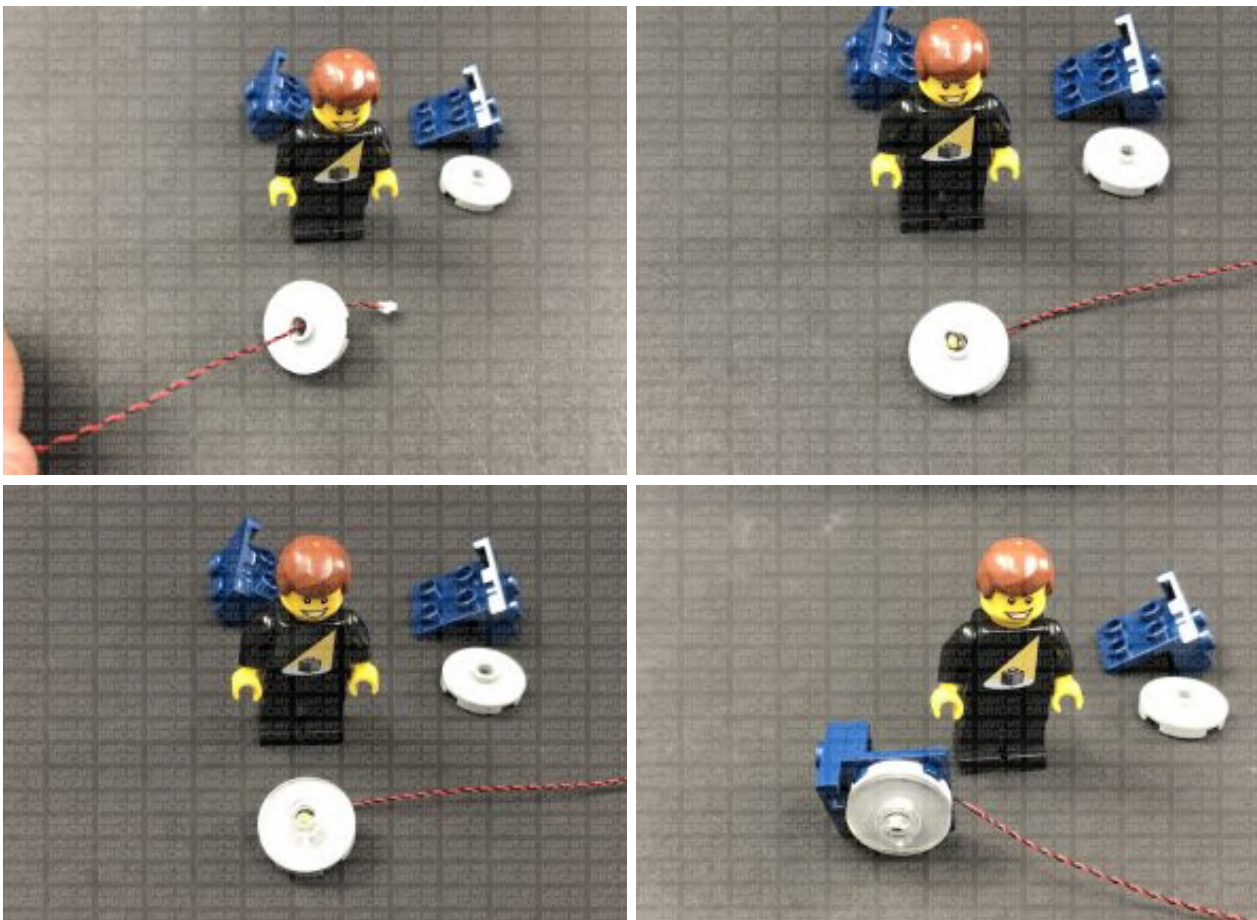



Repeat this process to install another **White 30cm Bit Light** to the right headlight.

Reconnect each headlight section back to the front of the car by first disconnecting the following section and threading the headlight cable through. Reconnect the headlight, then reconnect the section behind over the cable.

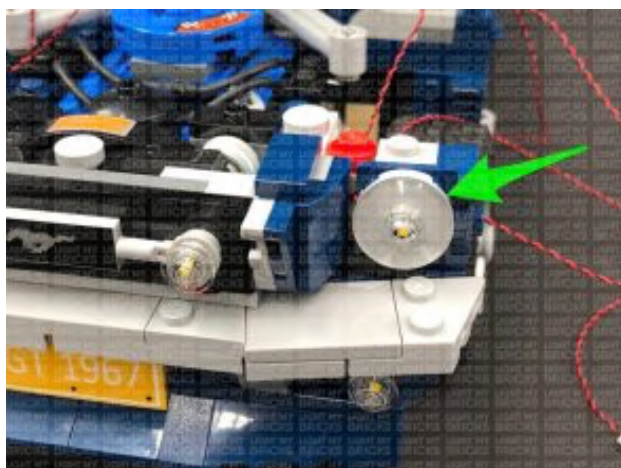
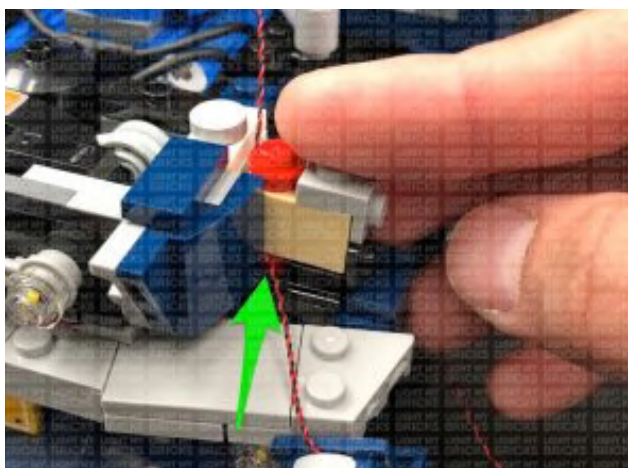
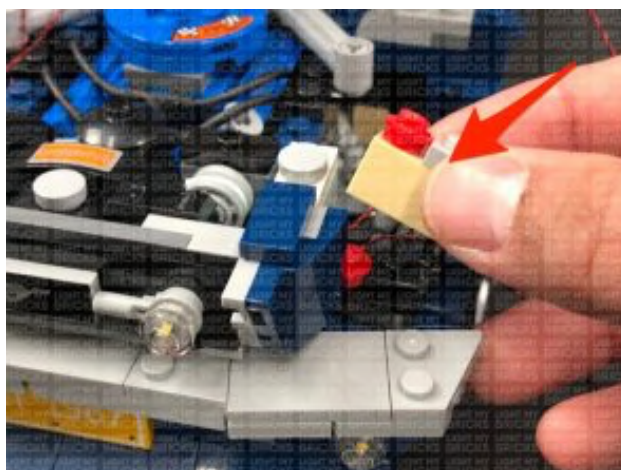
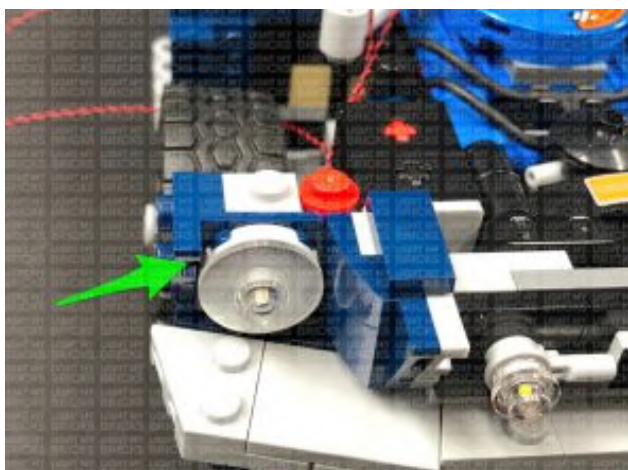
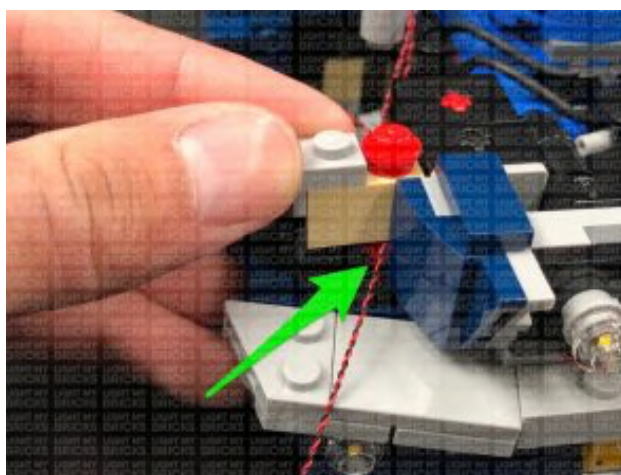
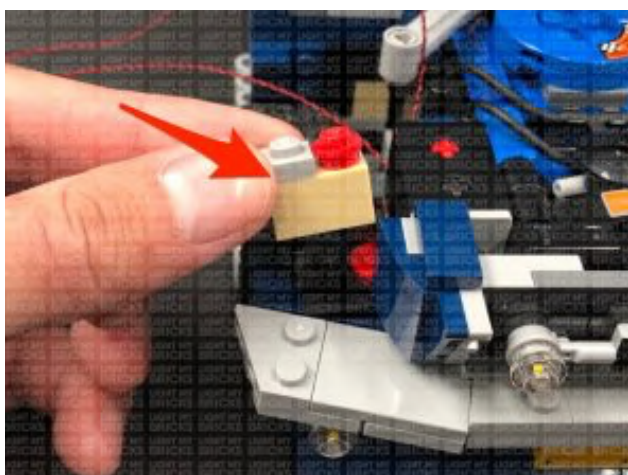



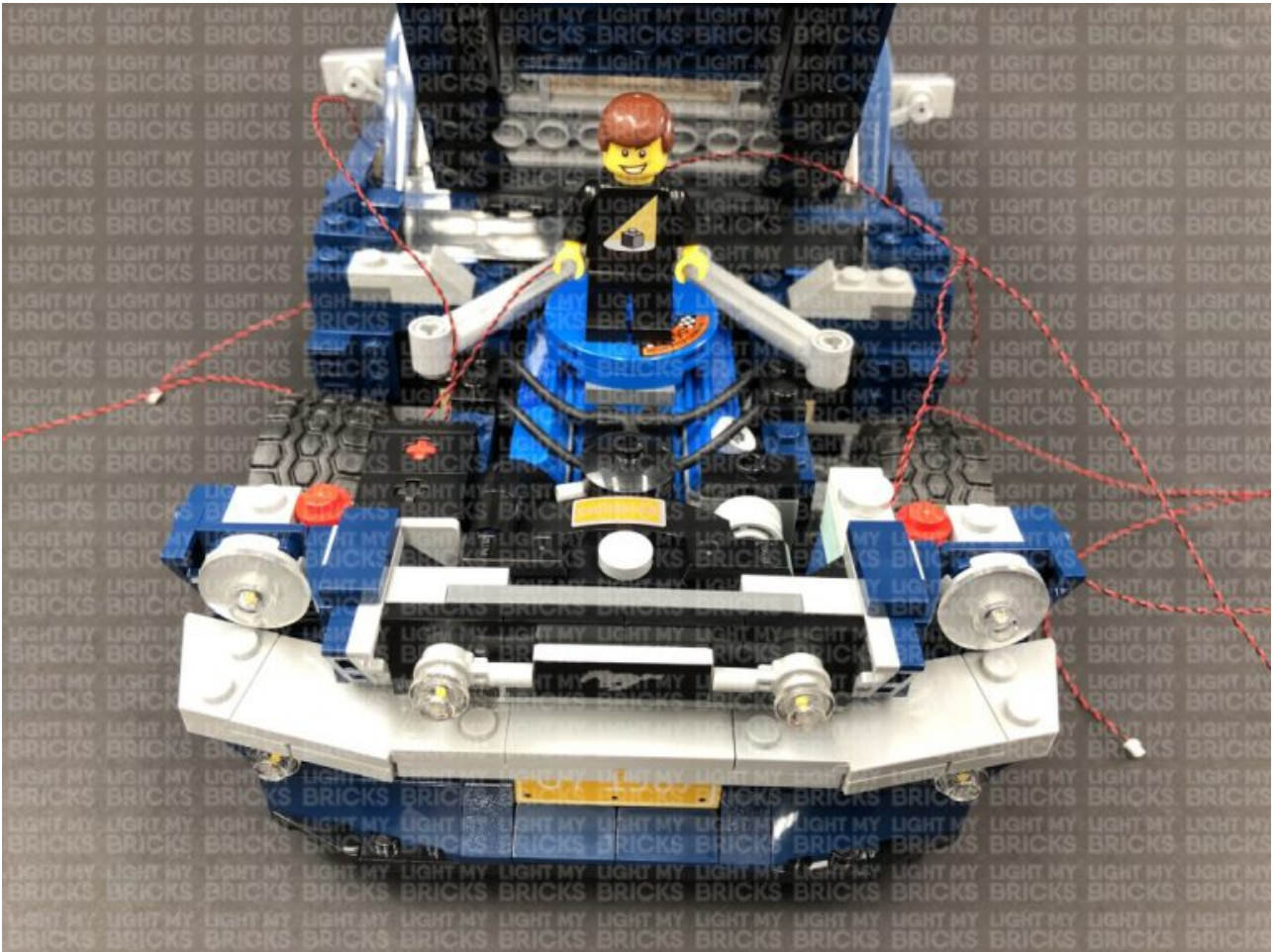

6.) We will now test all the lights installed so far are working OK. Take the **8-Port Expansion Board** and connect all six lights to it. Take the **Flat Battery Pack** and correctly insert 2x CR2032 Batteries to it, then connect the battery pack cable to a spare port on the expansion board. Turn the battery pack ON to test the lights are working OK.

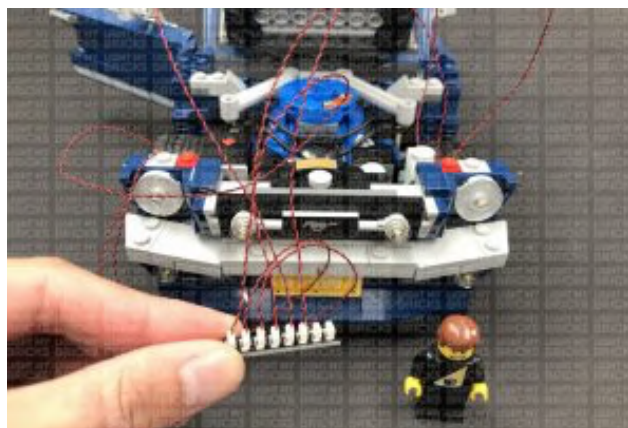
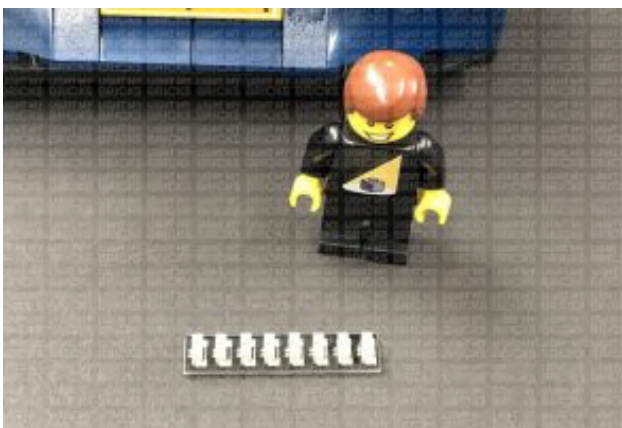

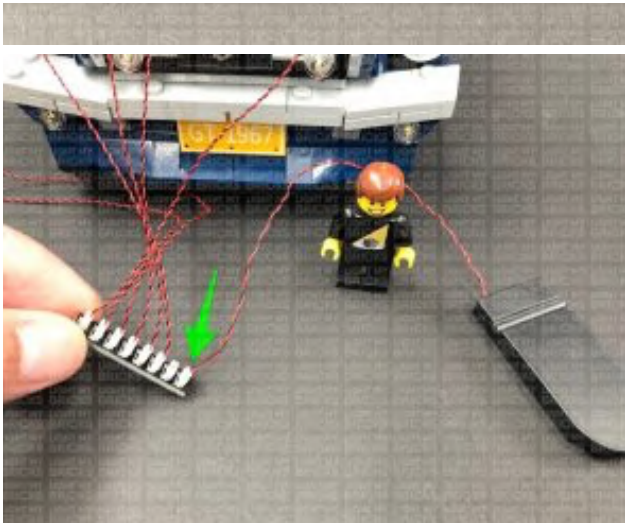

*Note: If you experience any issues with the lights not working and suspect an issue with a component, please try a different port on the expansion board to verify where the fault lies (with the light or expansion board). To correct any issues with expansion board ports, please view the section addressing expansion board issues on our **online troubleshooting guide**.*



7.) Disconnect the lights and battery pack from the expansion board, then take the three light cables from the left side of the car and thread them down the front of the wheel and pull them all the way out from underneath.

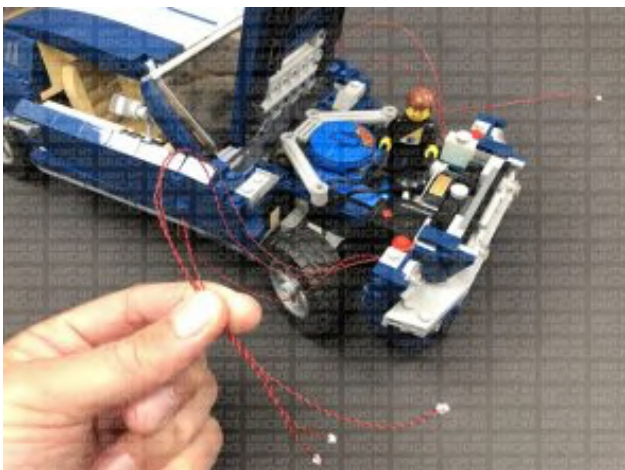
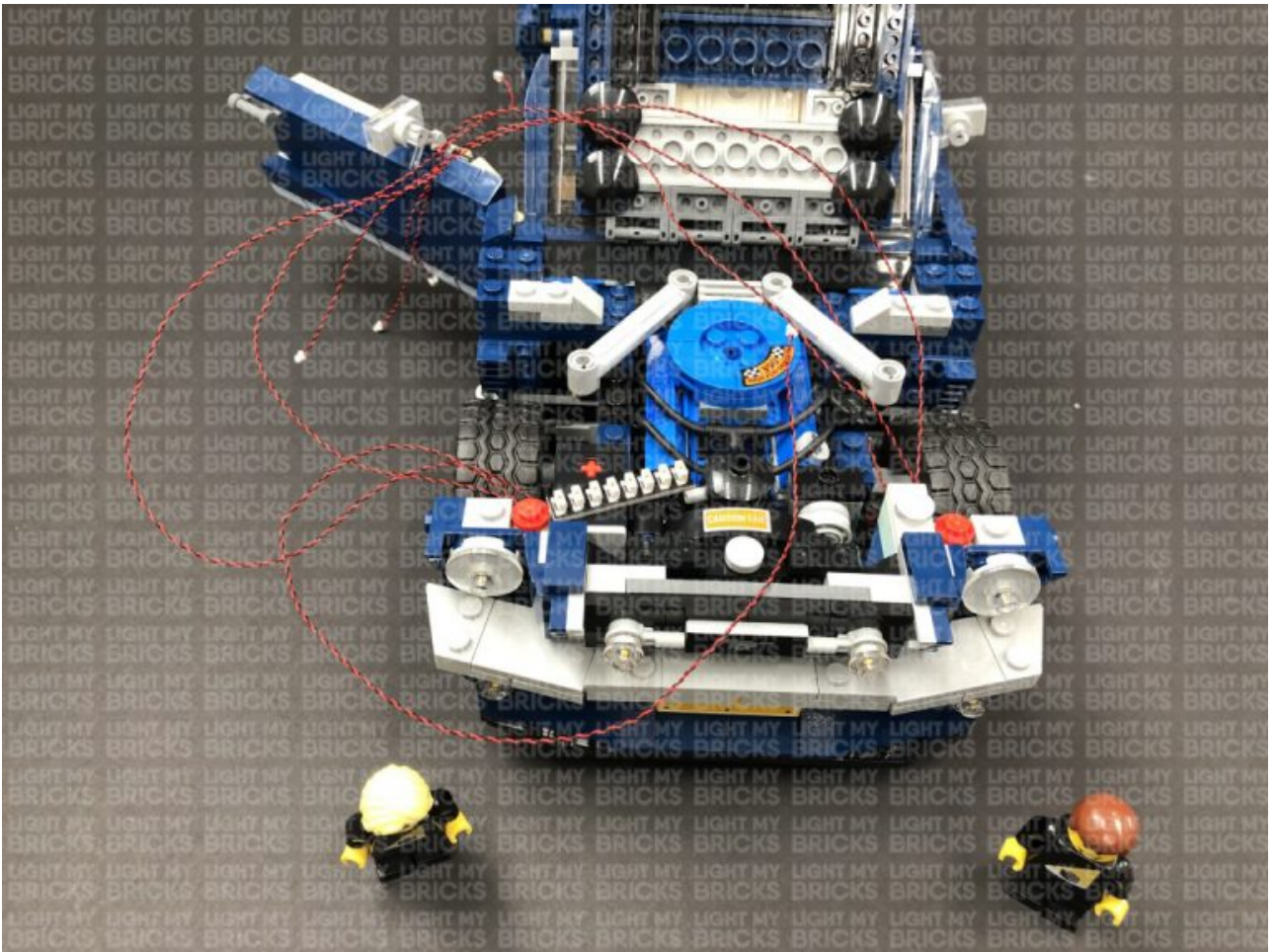



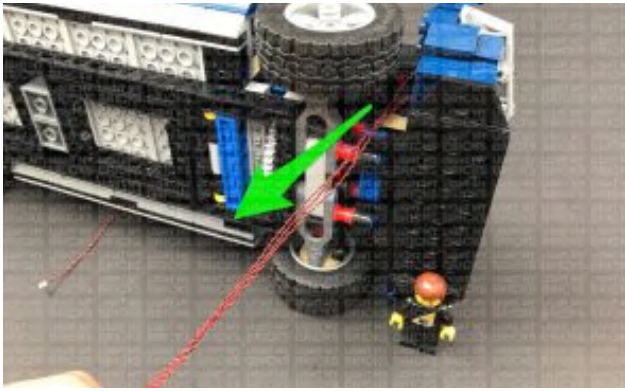

Thread all the three cables through the hole in front of the dark grey wheel axle, then pull them all the way out from the back of it.

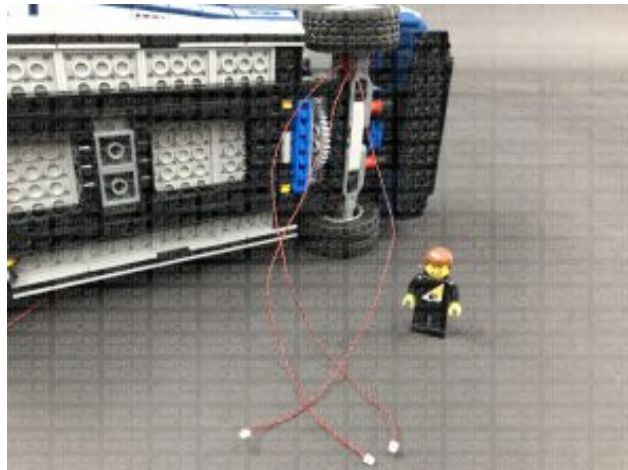
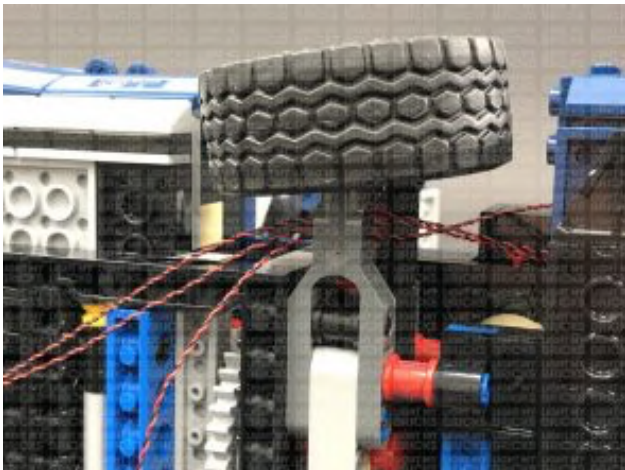
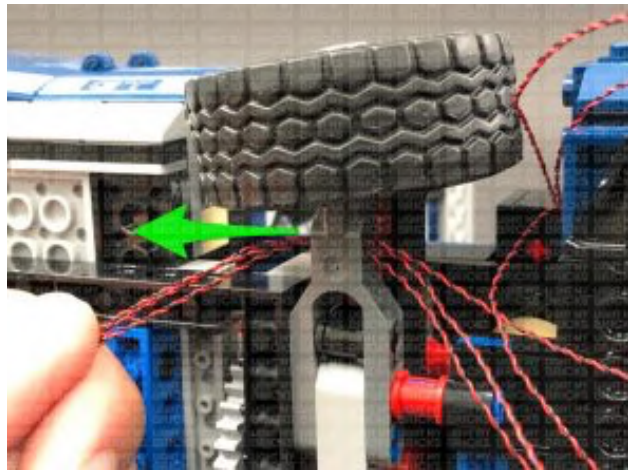
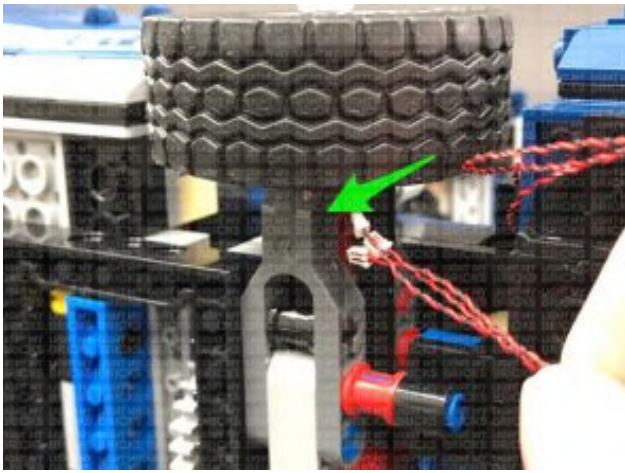

8.) Twist and wind the three cables around each other all the way to the end so they all come together to form one larger cable.



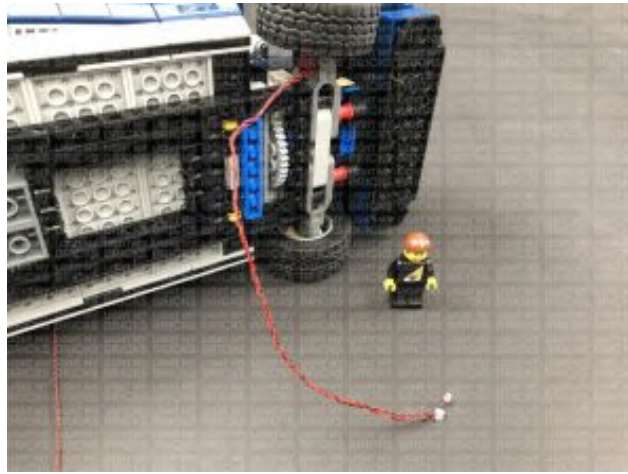
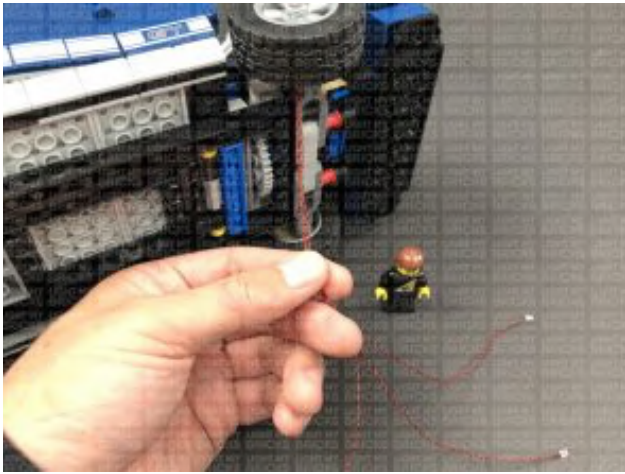

Thread the cables all the way through the following hole of the black technic brick, leading to the inside of underneath the car.

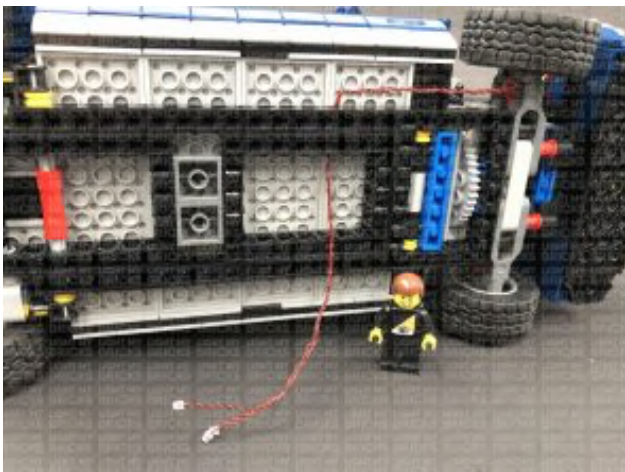
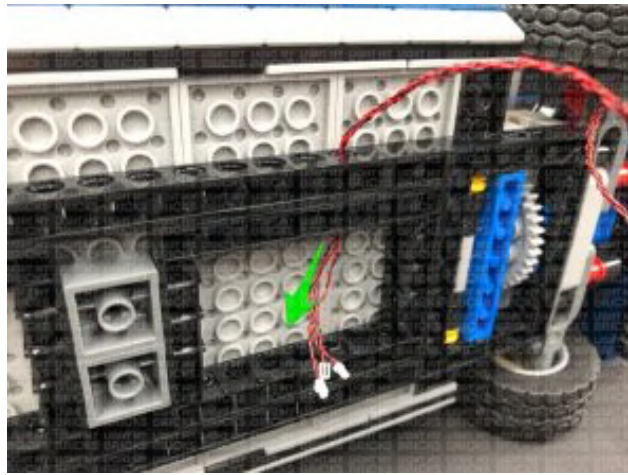
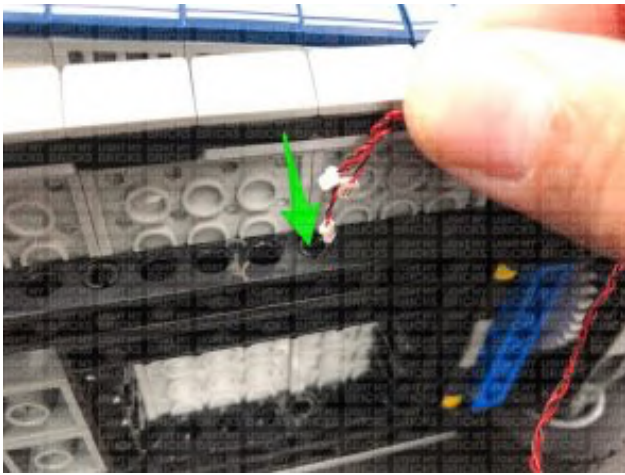

Pull the cables back out and then thread them through the following hole toward the back. Connect the three cables to the 8-Port Expansion Board, then turn the car back over and reconnect the side section of the bonnet.



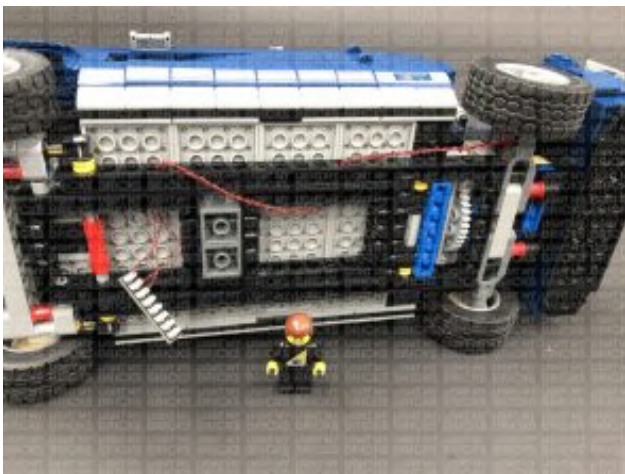
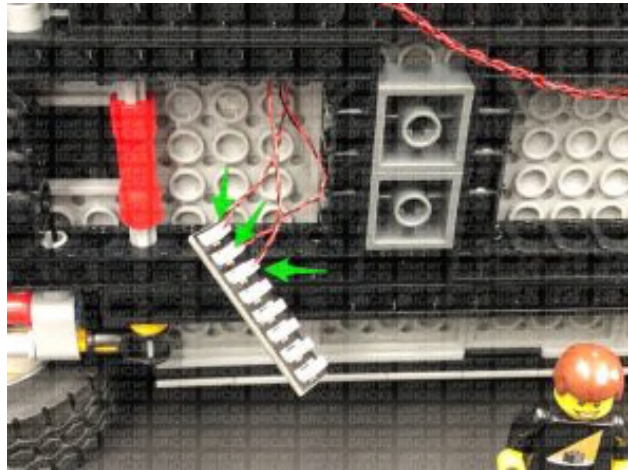
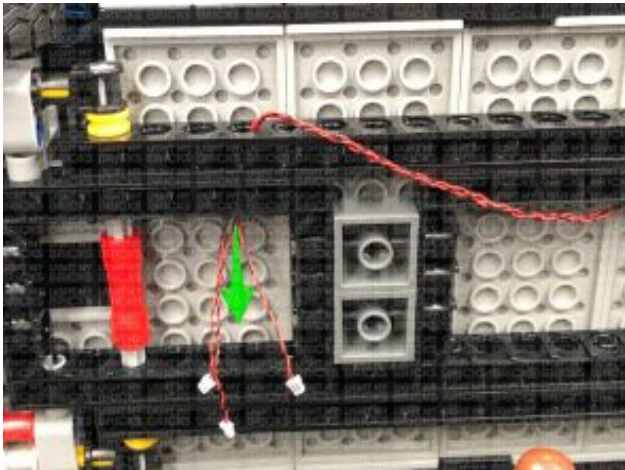
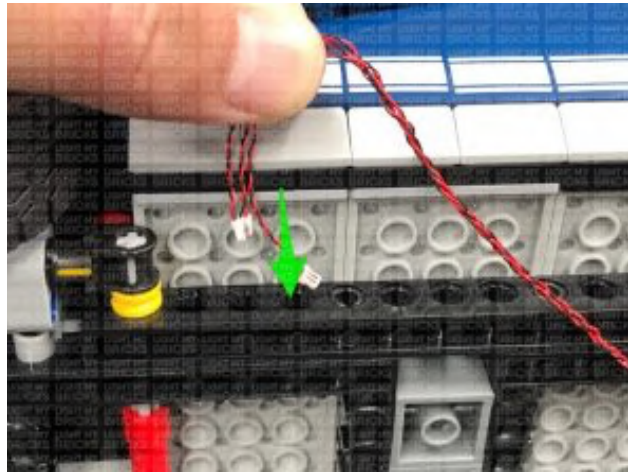
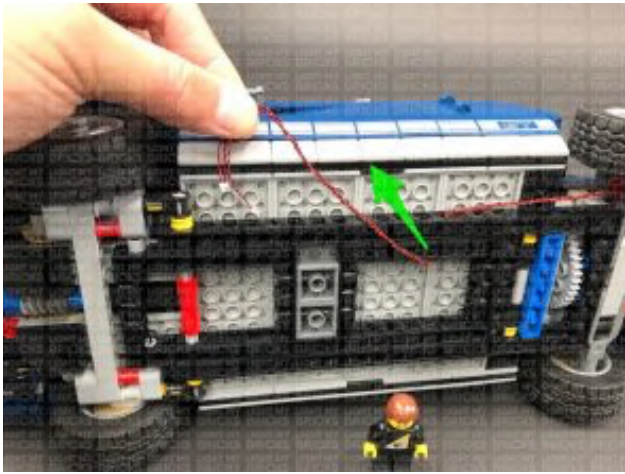

9.) Repeat previous 2 steps to thread the three cables on the right side of the car down underneath toward the back.





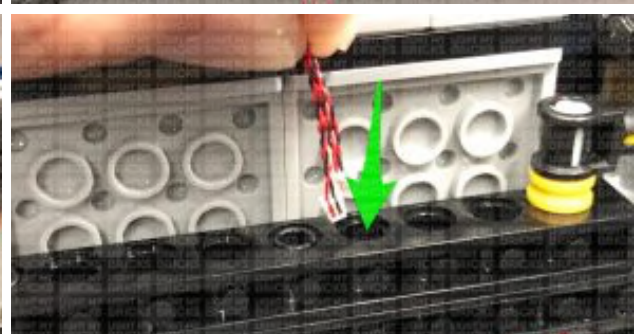
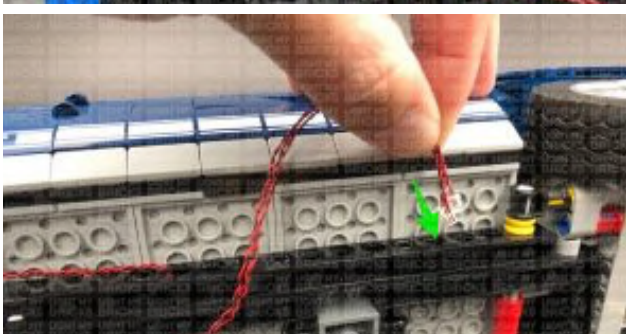
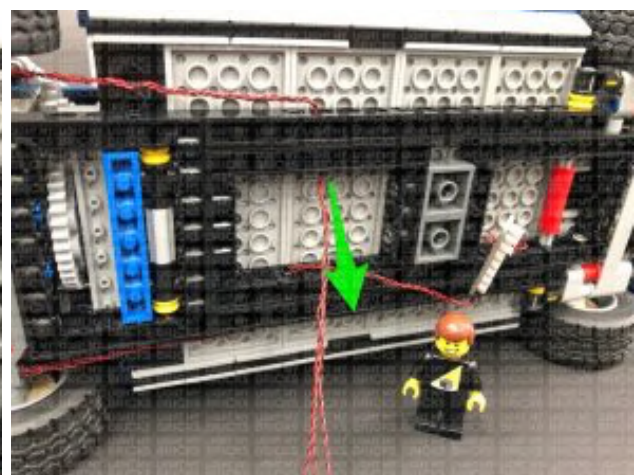
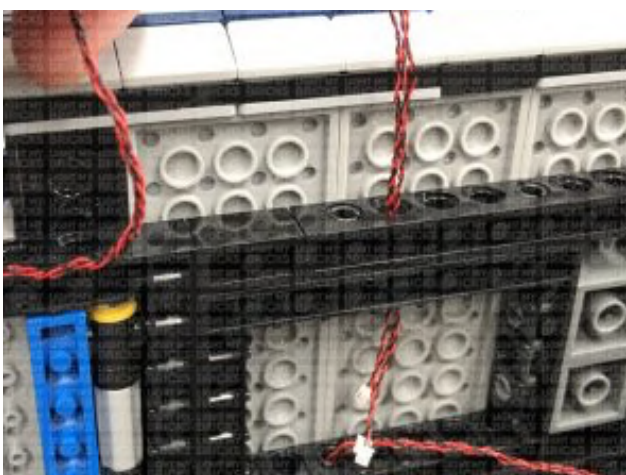
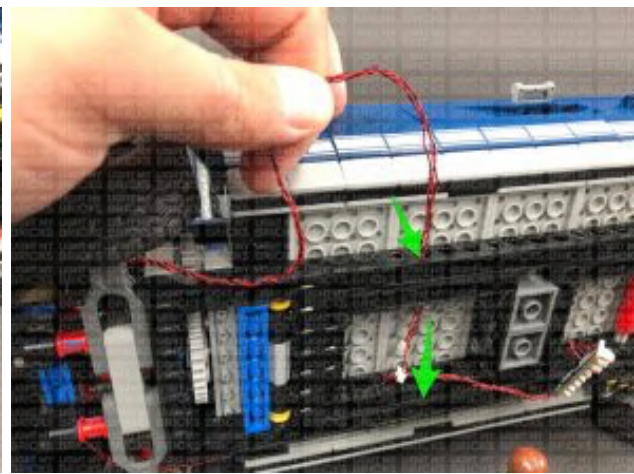
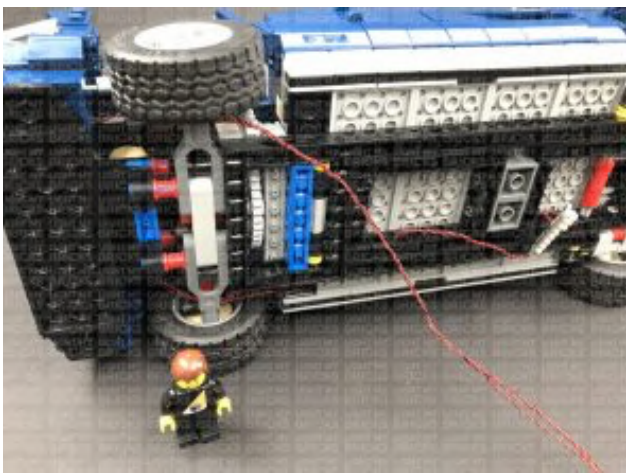
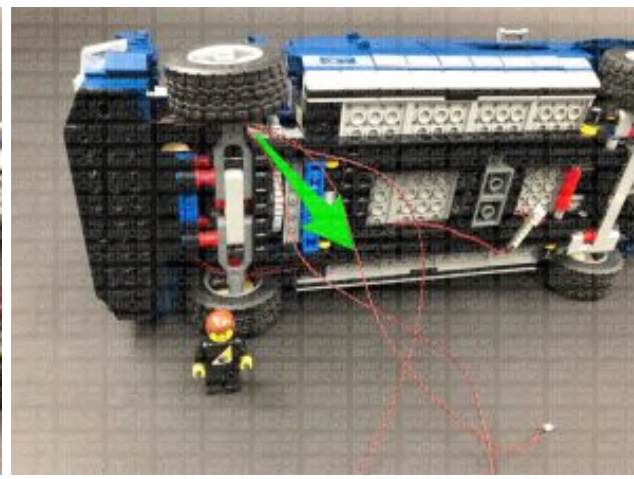
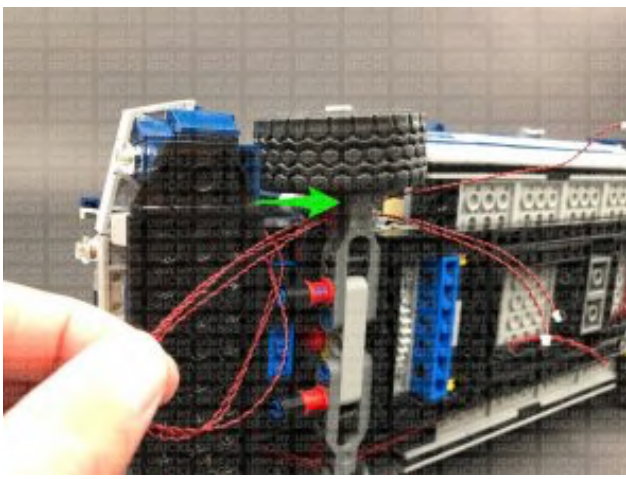
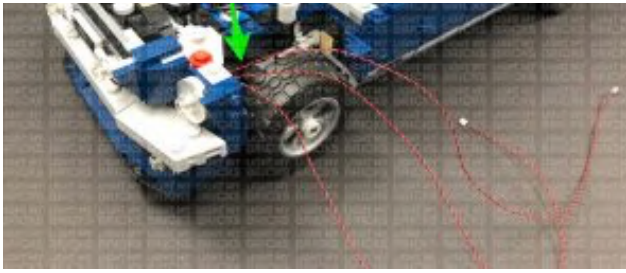



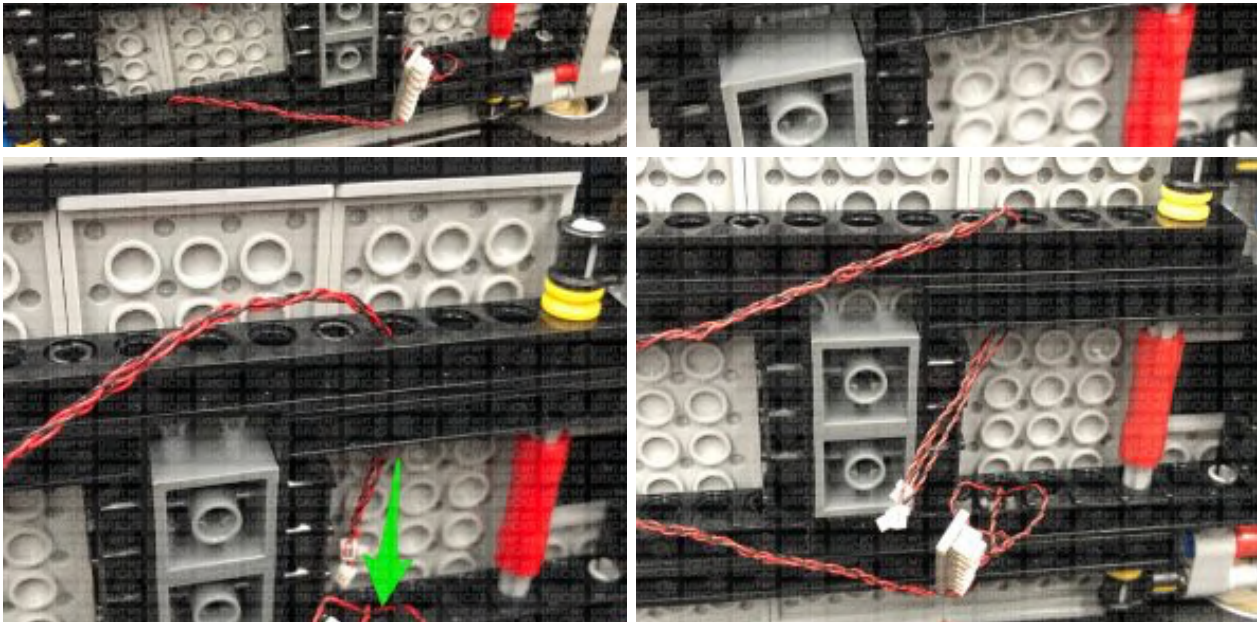

Connect the three cables to the 8-Port Expansion Board, then flip the car over and reconnect the right bonnet section.

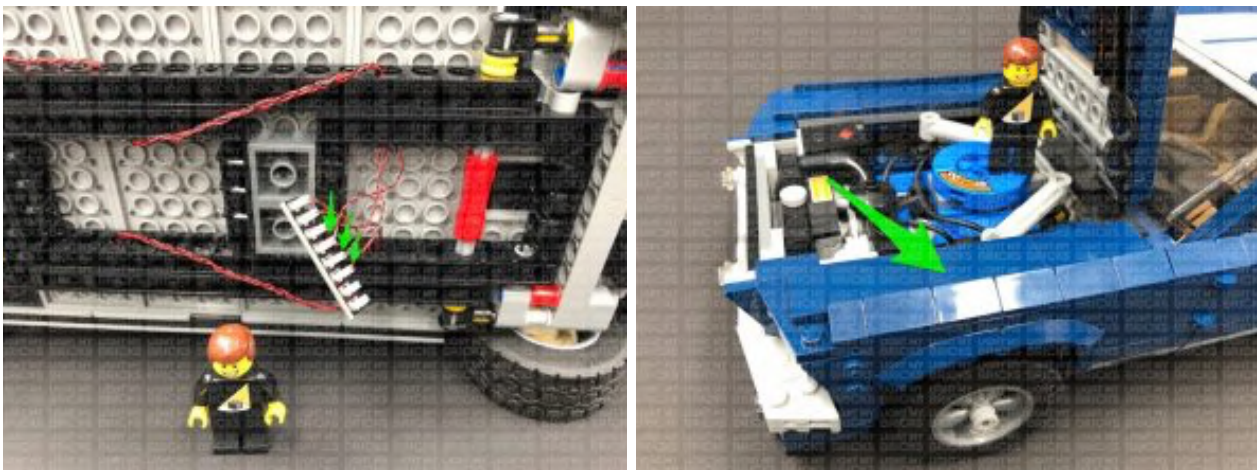

**10.)** We want to eliminate excess cable from dangling down underneath the car. To do this, twist the expansion board underneath the car around a few times to tighten the cable.





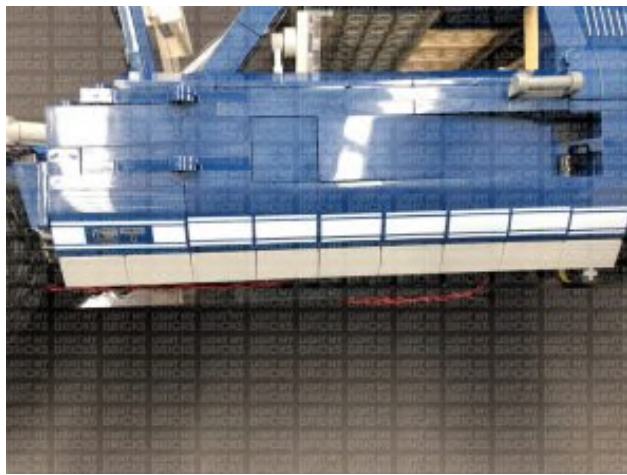
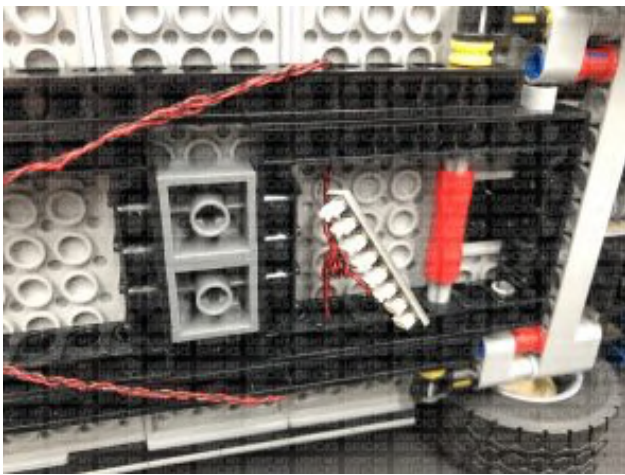
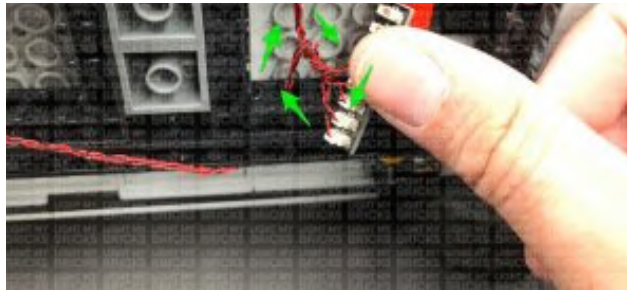

11.) We will now install a light to the interior. First disconnect the roof of the car, then flip this section over and disconnect the black plate from underneath.

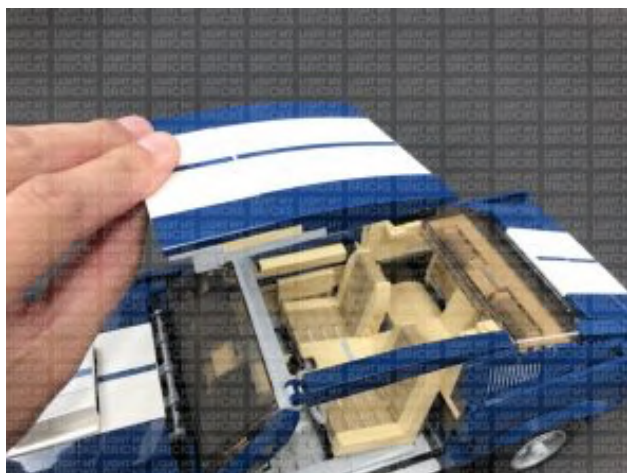
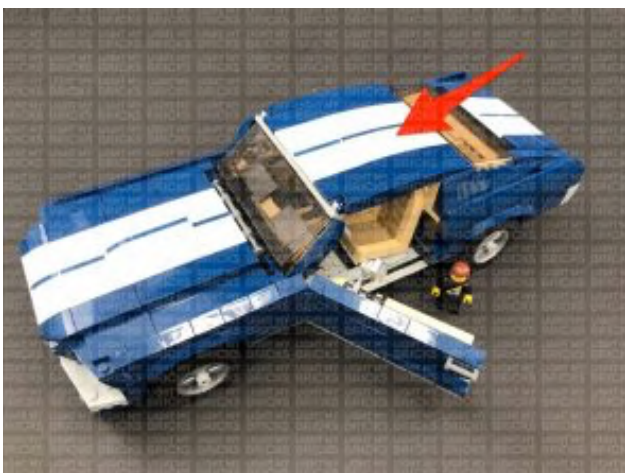

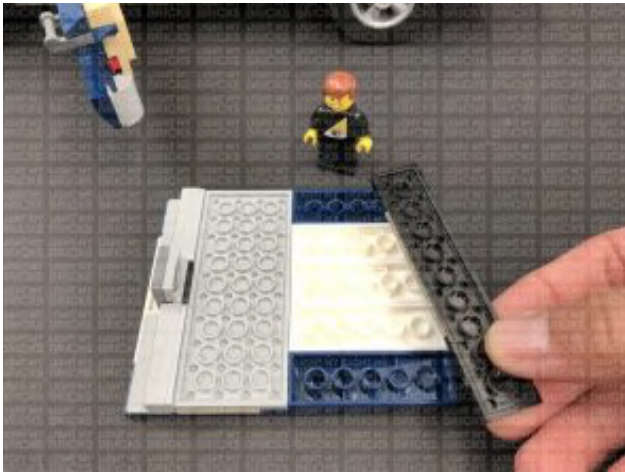

12.) Take a **White 30cm Bit Light** and with the cable facing the right side as per below, place it in the following position. Secure the Bit Light in place by connecting a provided **Trans Clear Plate w Rounded Bottom 2x2**.

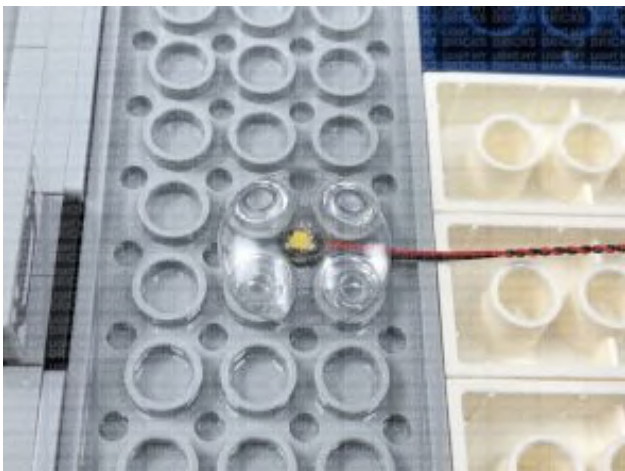
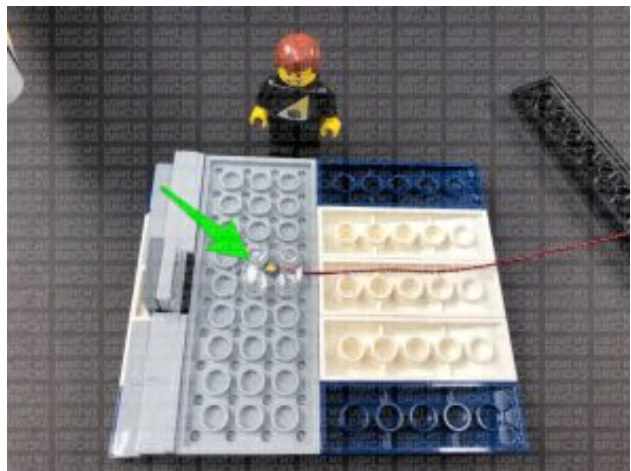
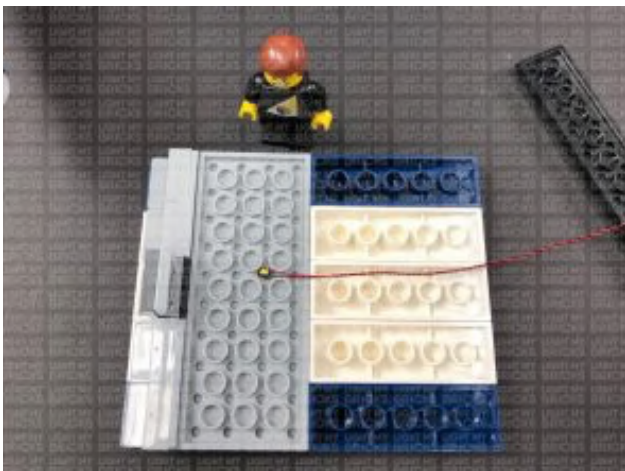



Reconnect the black plate ensuring the cable underneath is laid in between studs.

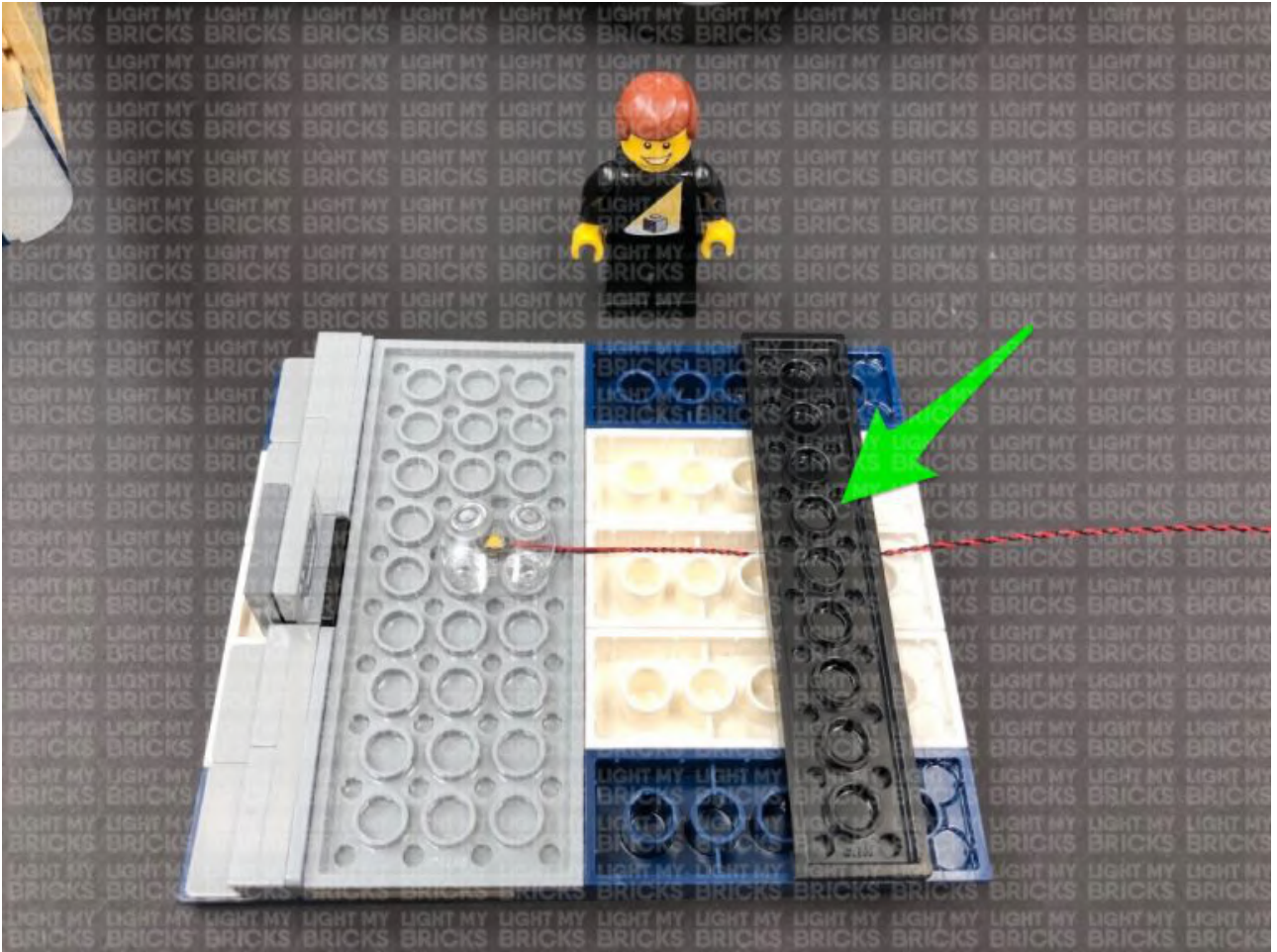

**13.)** Lift up the back side of the top left section, then reconnect the roof and lay the cable out underneath the top left section as shown below:

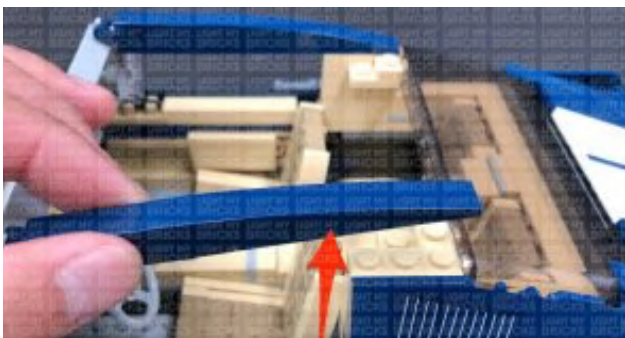



Bring the cable back inside the car and secure it in between the top left section and the top of the car.

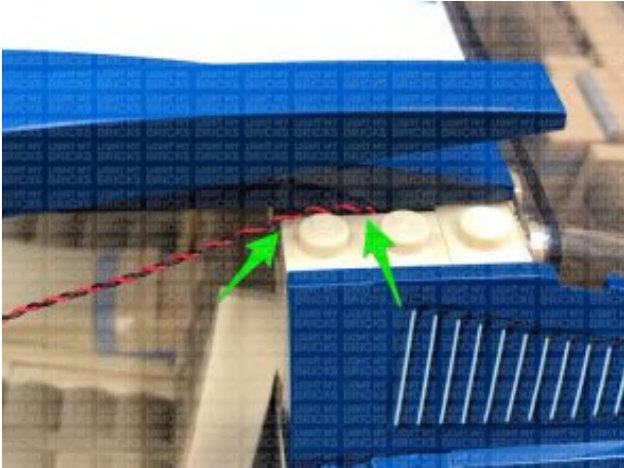

14.) Remove the driver seat then take the **NC Push Board** and connect the interior Bit Light to the OUT port. Take a **30cm Connecting Cable** and connect it to the IN port on the NC Push Board. The NC Push Board will deactivate the internal light when the button is pushed, and activate the light when it is released. This will simulate the internal light turning on when the driver door opens.

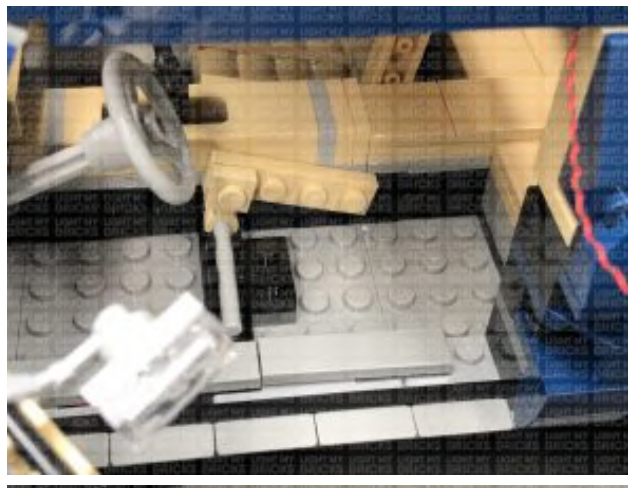



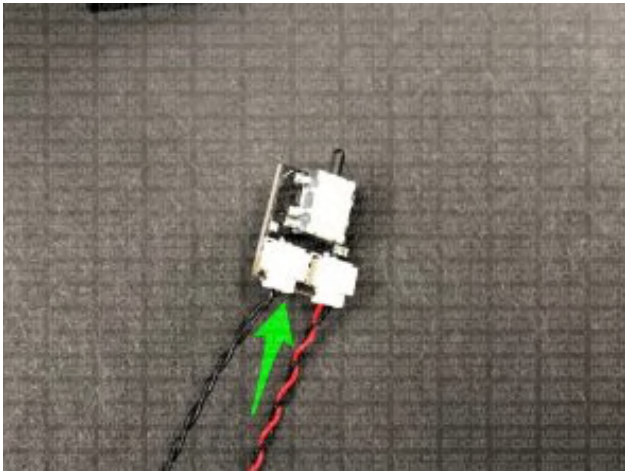
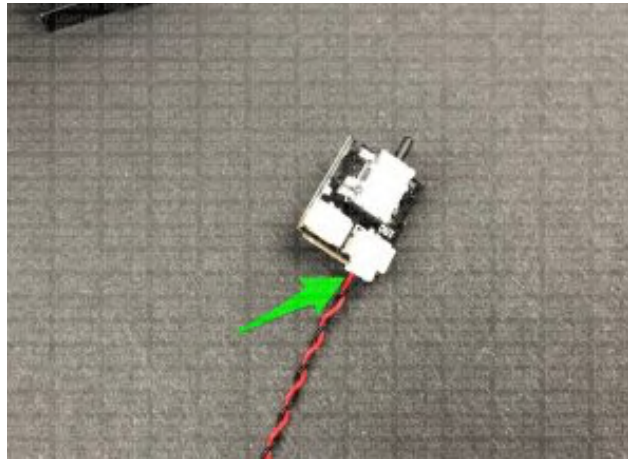
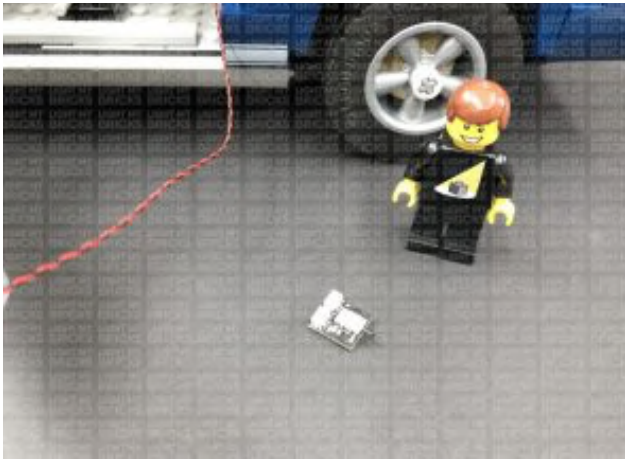

Thread the other end of the 30cm Connecting Cable through the following hole which leads to the passenger side of the vehicle. Pull the cable all the way out from the other side.

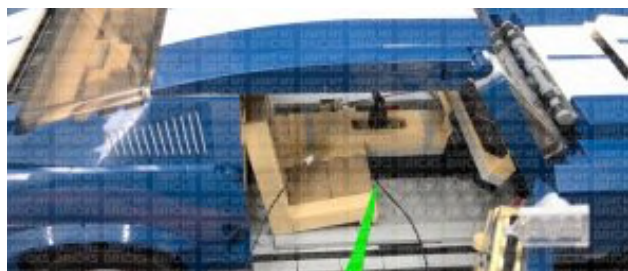
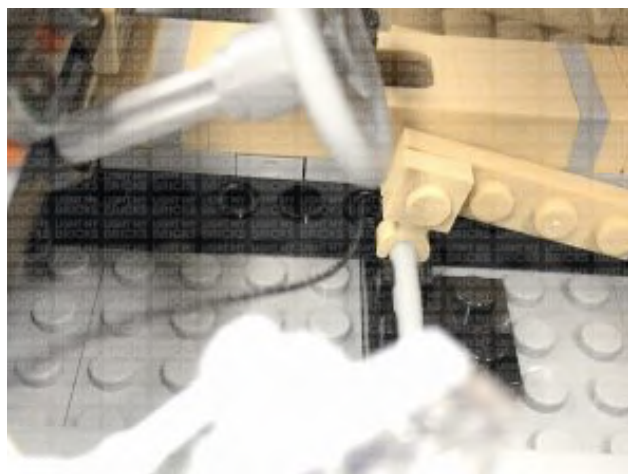
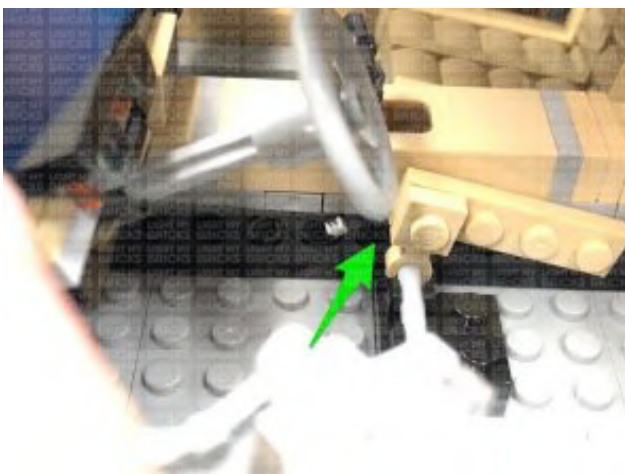

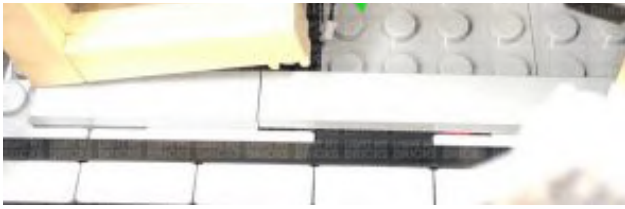

Flip the car over onto it's side and thread the cable through the same hole on the black technic brick which we threaded the front three cables through underneath the car. Connect the cable to the 8-port Expansion Board.

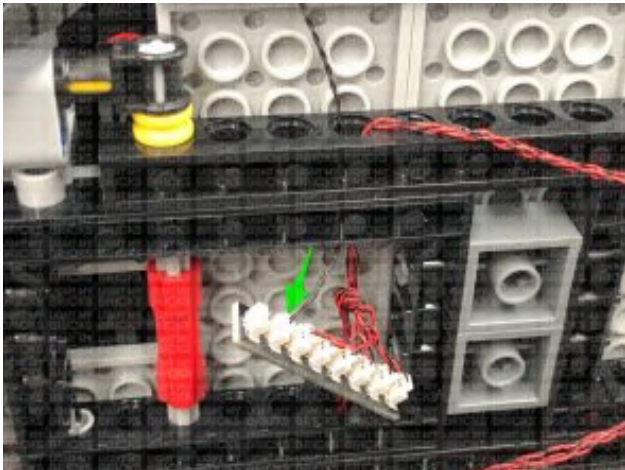
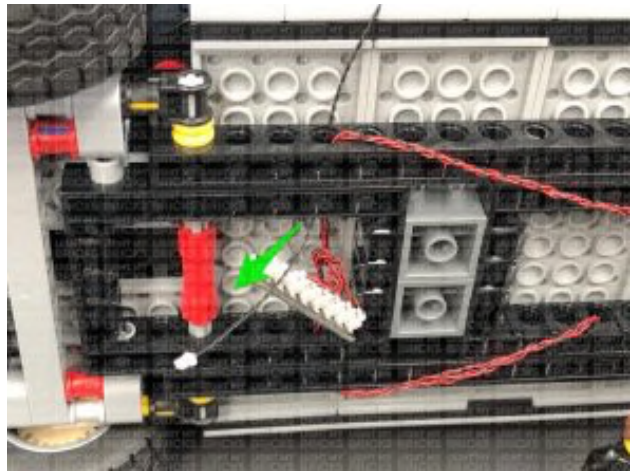
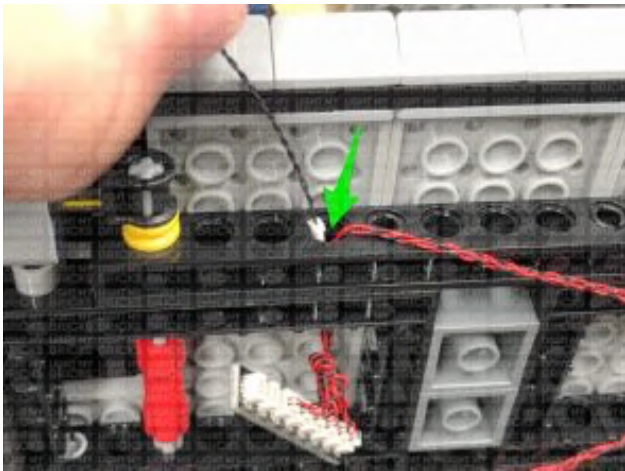

Secure the cable by reconnecting the following light grey angled tile over the top, ensuring the cable is laid in between studs.





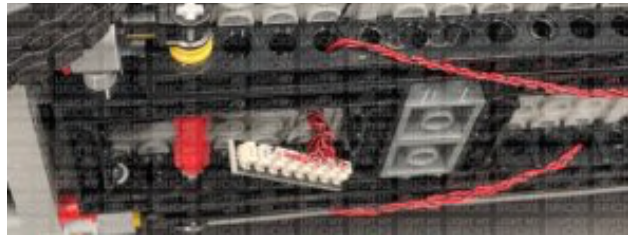

**15.)** Remove the passenger seat then secure the cable underneath the following light grey tile. Neatly bunch up the excess from the connecting cable underneath the passenger seat, then reconnect the passenger seat over the top.

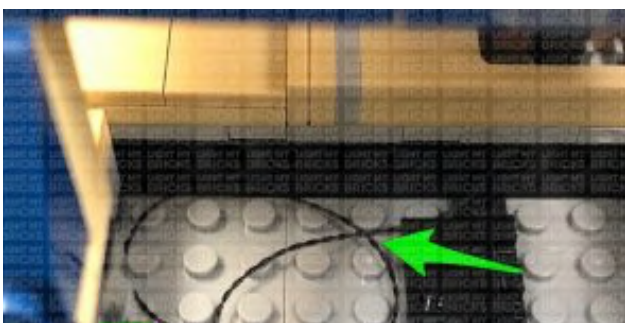
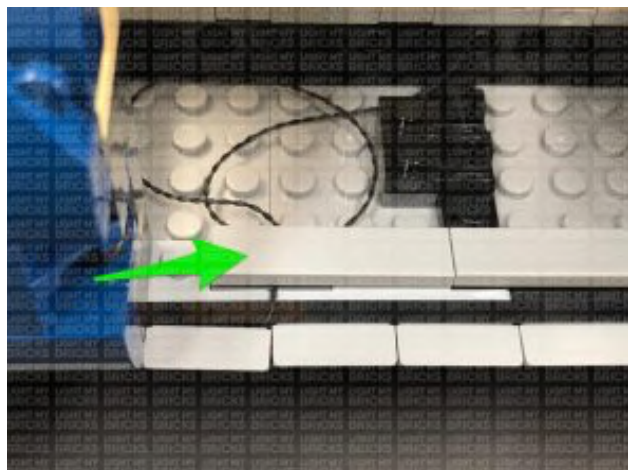
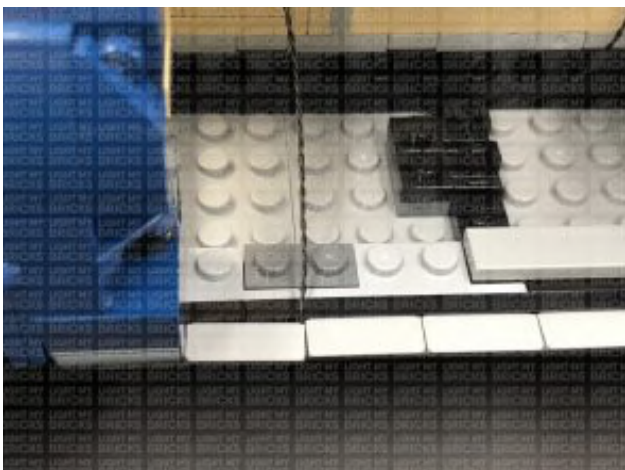
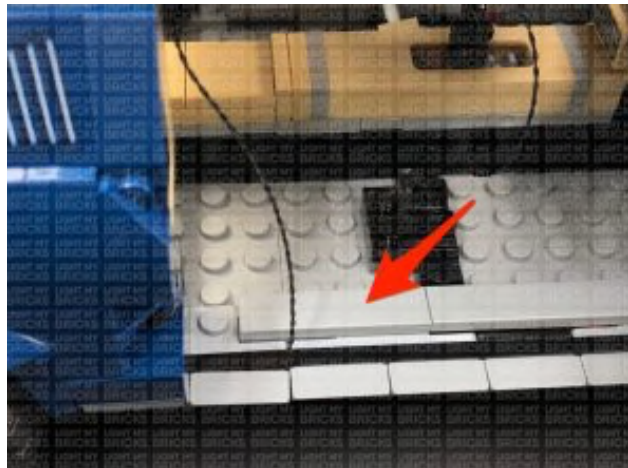
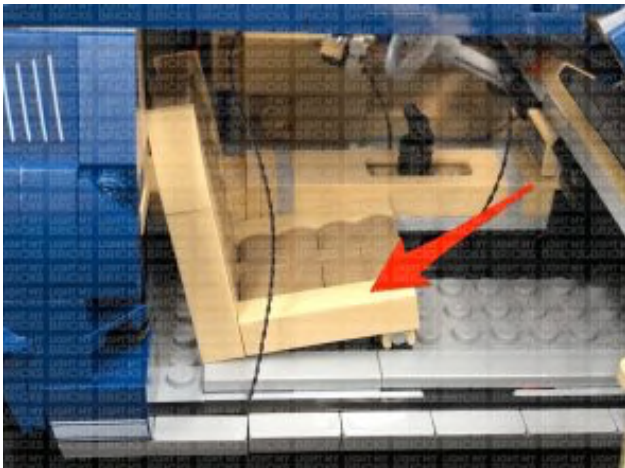



**16.)** From the driver side of the car, slightly pull the NC push board out and using it's adhesive backing, mount the board to the bottom of the door entrance in the following position. Ensure the push button facing is out and that the edge of the board is in line with the edge of the door way, so that when the door closes, it pushes the button to de-activate the internal light.

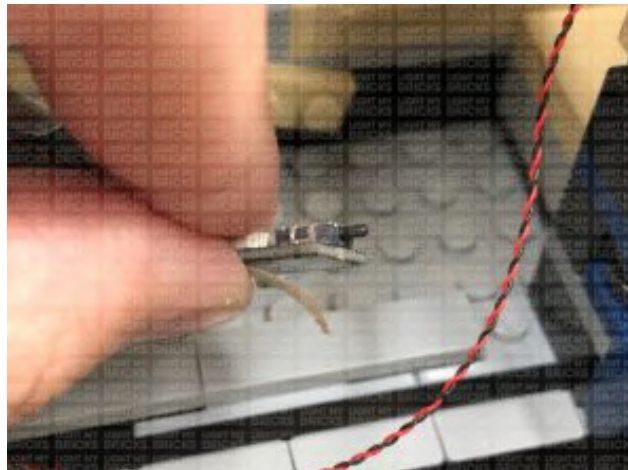
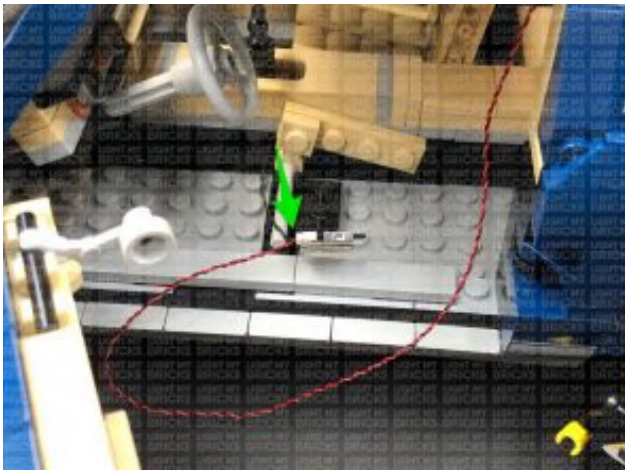



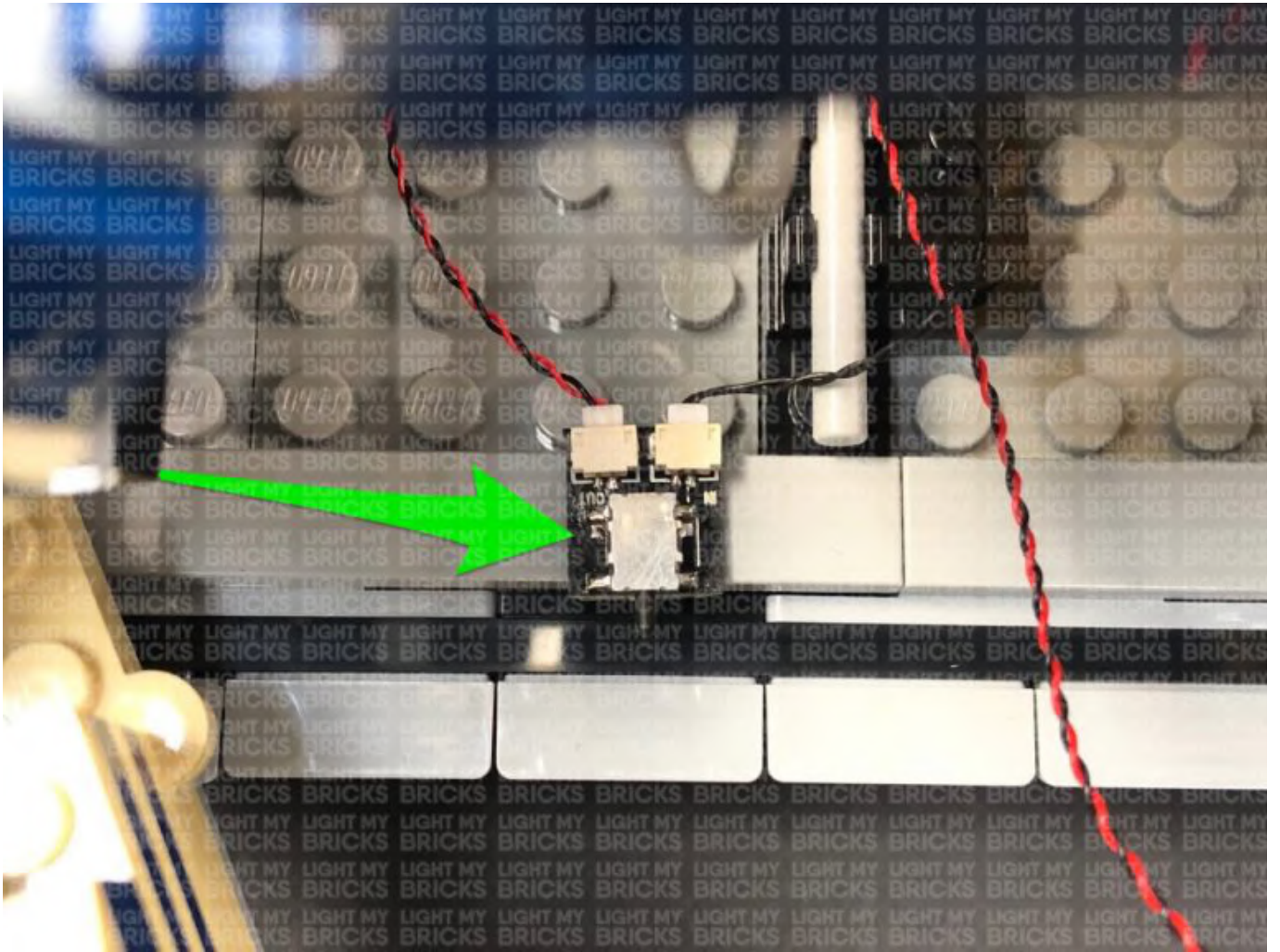

Neaten up the cables and place it underneath the driver seat before reconnecting the driver seat. Test the NC Push Board is mounted correctly by ensuring you can open and close the door OK.

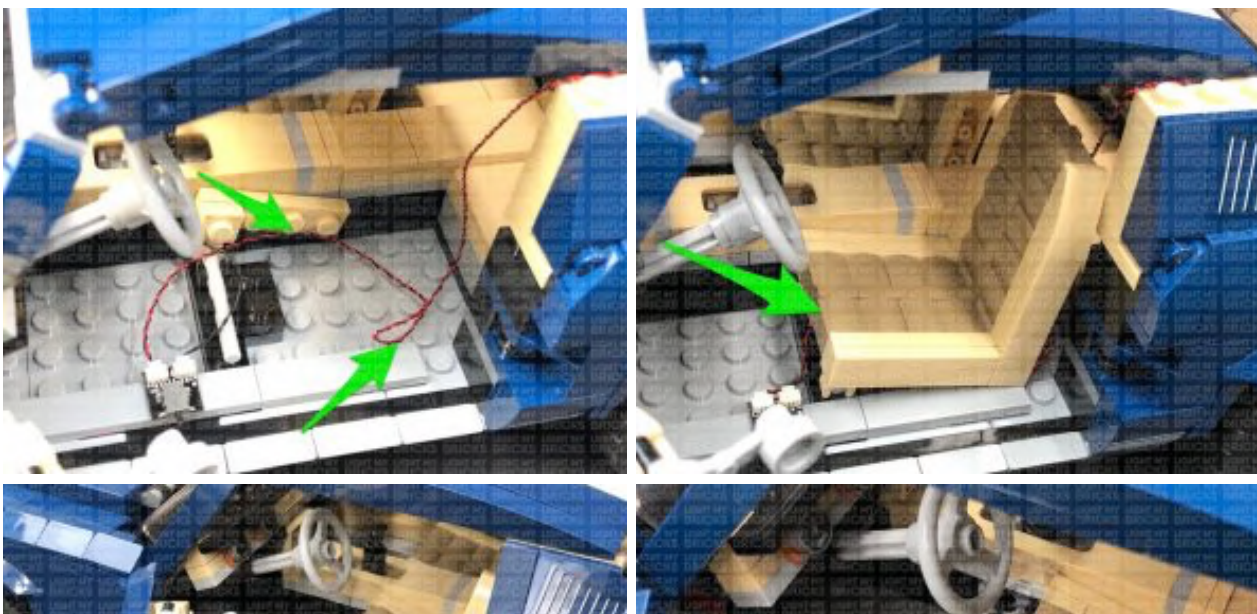



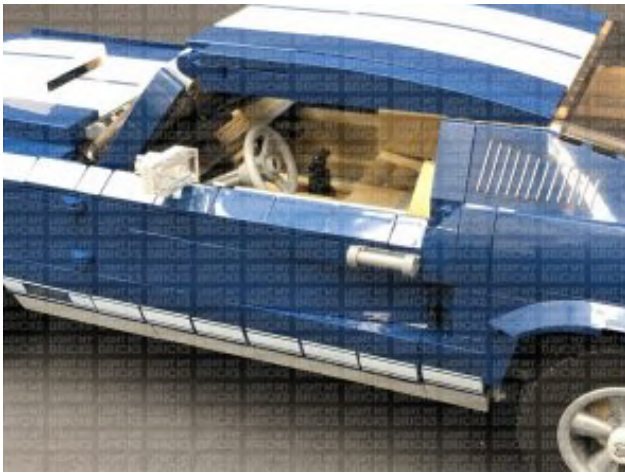
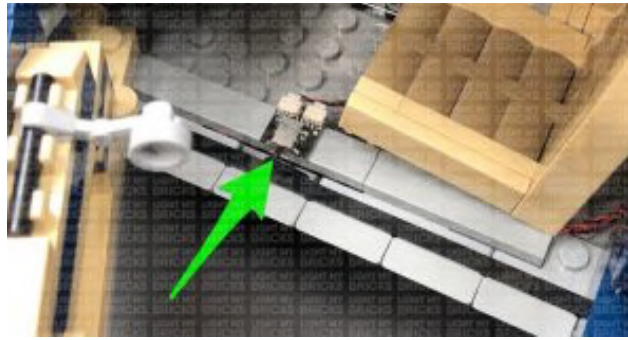

17.) Take a **12-Port Expansion Board** and connect a **15cm Connecting Cable** to the end port. Open up the boot of the car and thread the other end of the 15cm connecting cable through the back right corner. The cable should lead down underneath the car. Flip the car over onto it's side, then pull the cable all the way out and connect it to the remaining port on the 8-port Expansion Board as shown below:

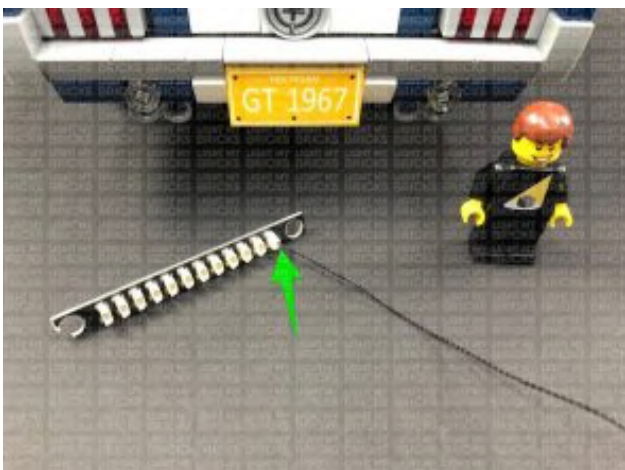



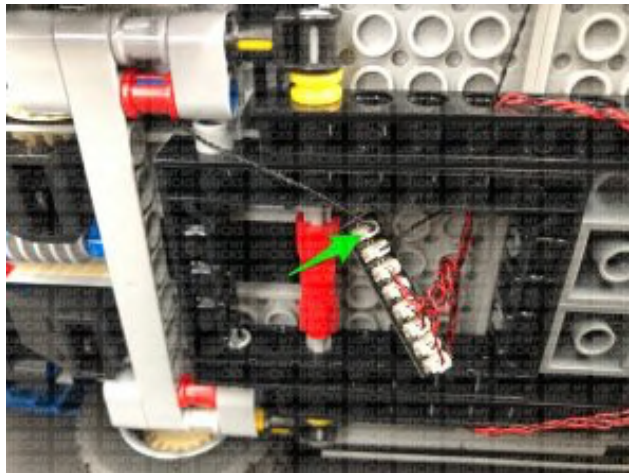
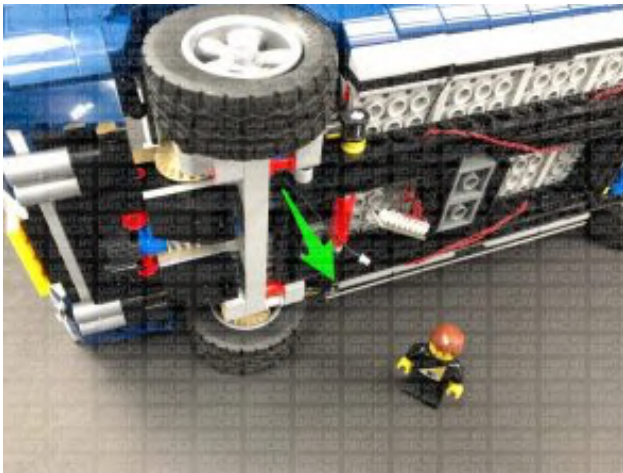
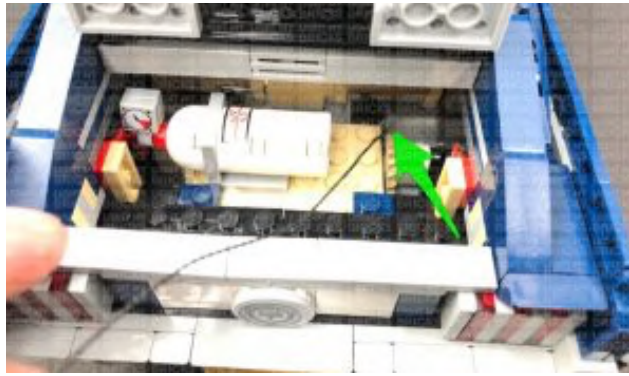

Flip the car back over and disconnect the tank from the boot. Lay the cable neatly in between studs before reconnecting the tank over the top.

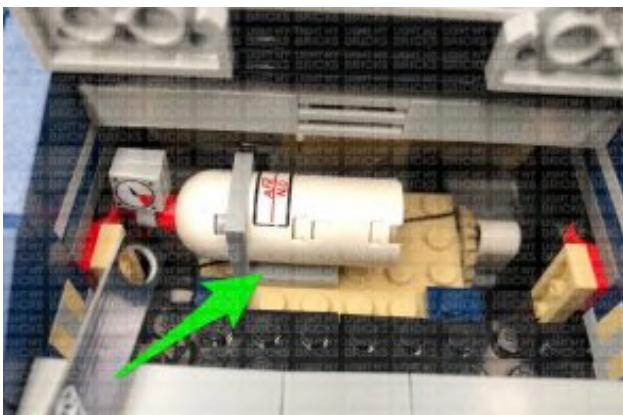
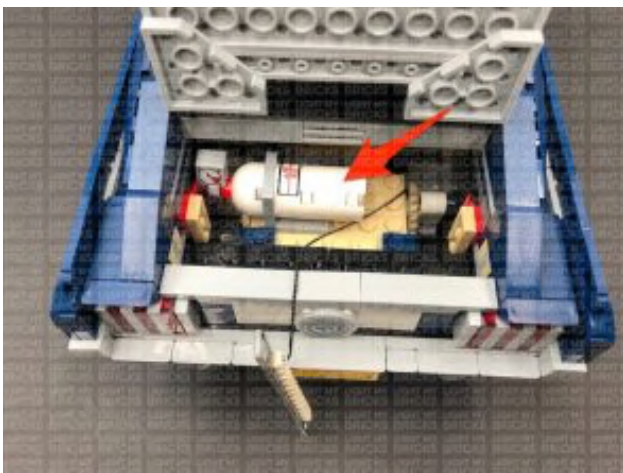

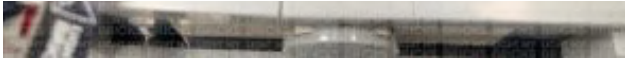

18.) Neatly place the 12-Port Expansion Board inside the boot and connect the Flat Battery Pack to the other end port of the expansion board. Turn the Battery Pack ON to test all lights are working including the internal light with the NC Push Board. The internal light should turn on when the driver door is open, and turn off when the door is closed.

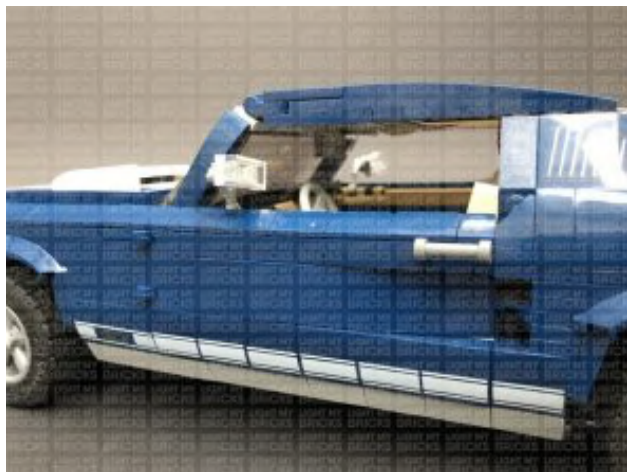
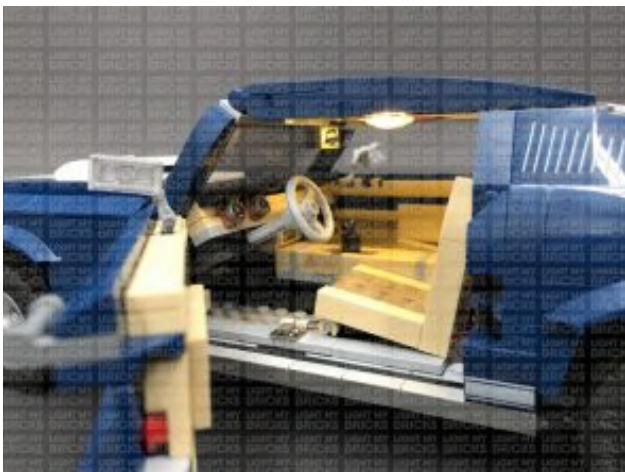
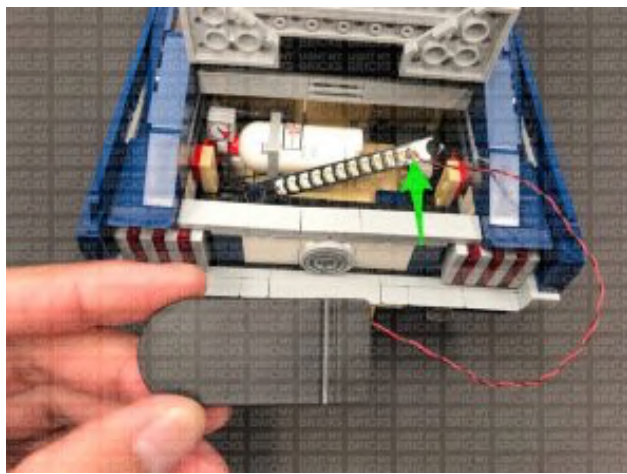
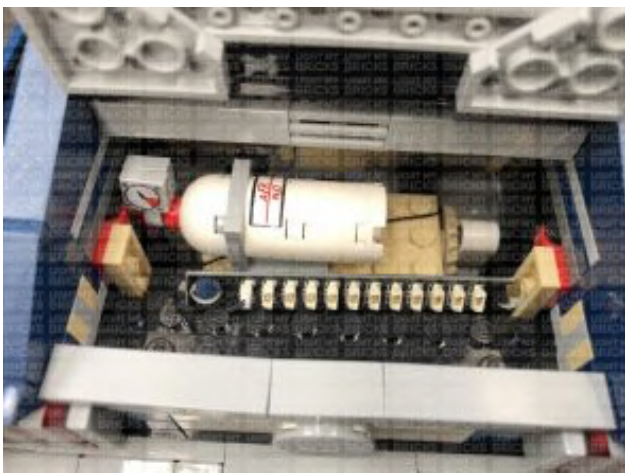

*Note: If you experience any issues with the lights not working and suspect an issue with a component, please try a different port on the expansion board to verify where the fault lies (with the light or expansion board). To correct any issues with expansion board ports, please view the section addressing expansion board issues on our **online troubleshooting guide**.*



19.) Disconnect the following sections from the back of the car.

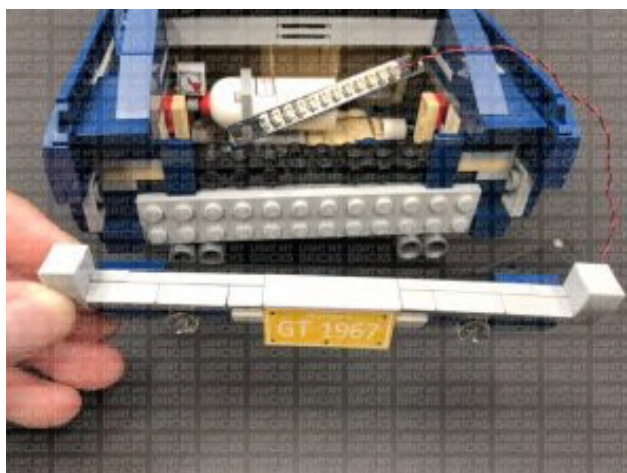
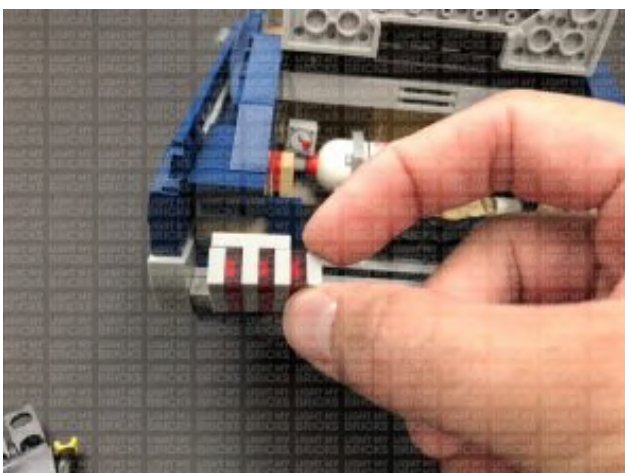
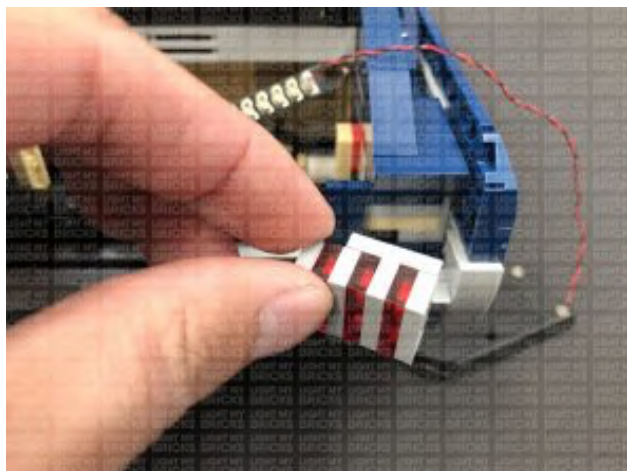
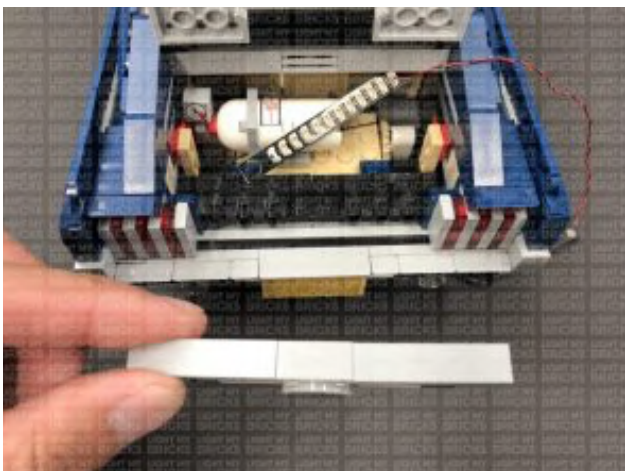
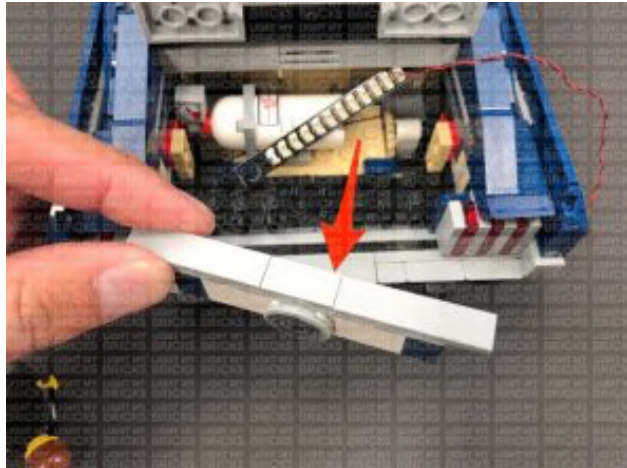
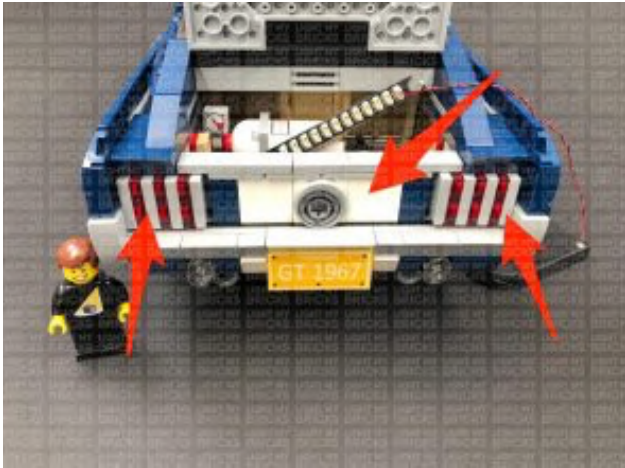

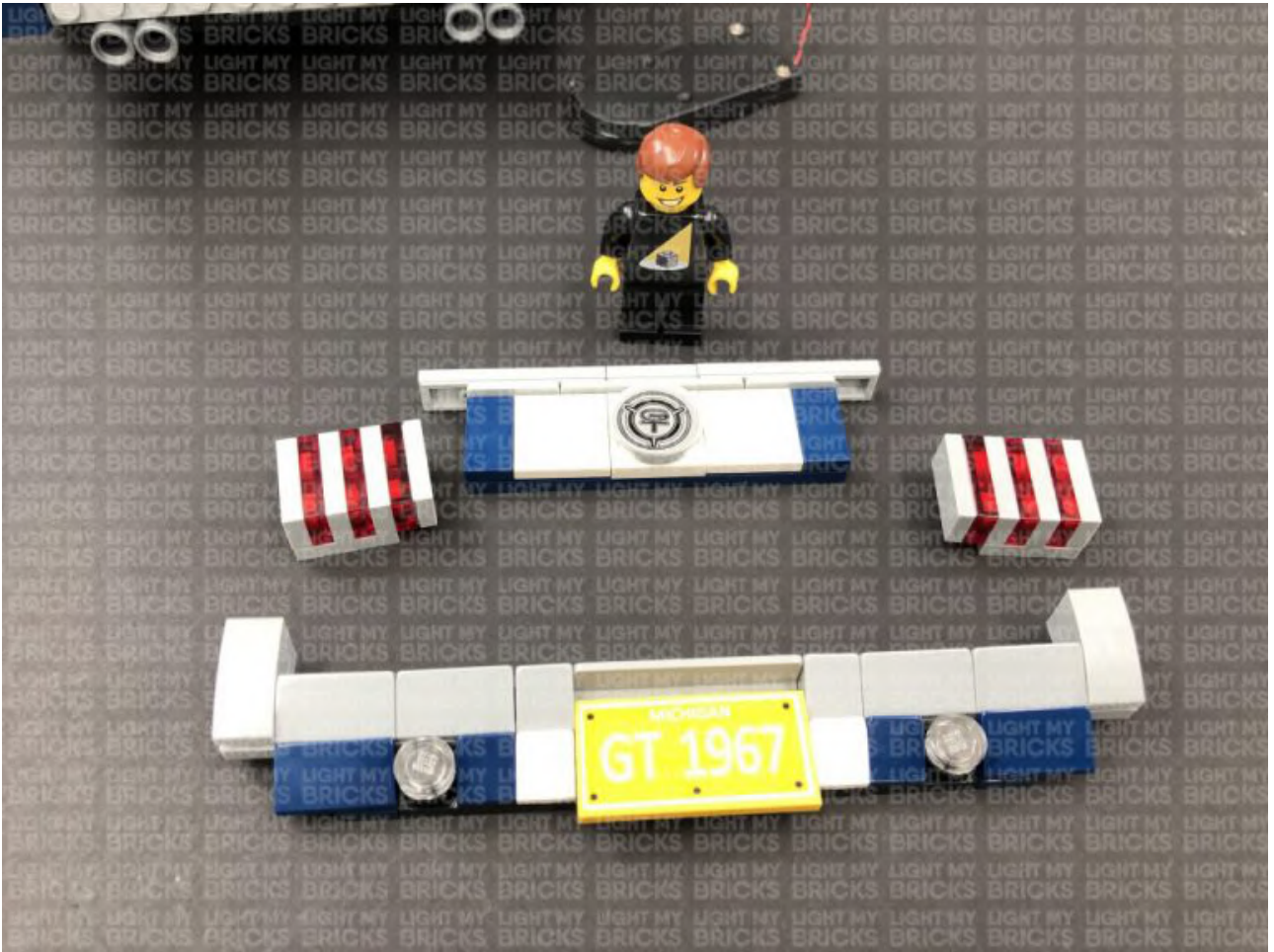

20.) Take the bottom section and disconnect the following pieces from it.

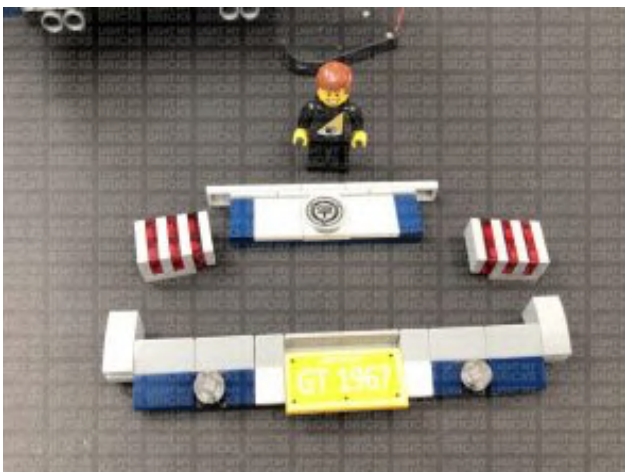



Take a **White 15cm Bit Light** and place it directly over one of the black round plates. Secure the light in place by connecting a provided **Trans Clear Round Plate 1x1** over the top. With the cable facing up, reconnect it to the bottom section, then reconnect one of the angled tiles over the top ensuring the cable is laid in between studs underneath.

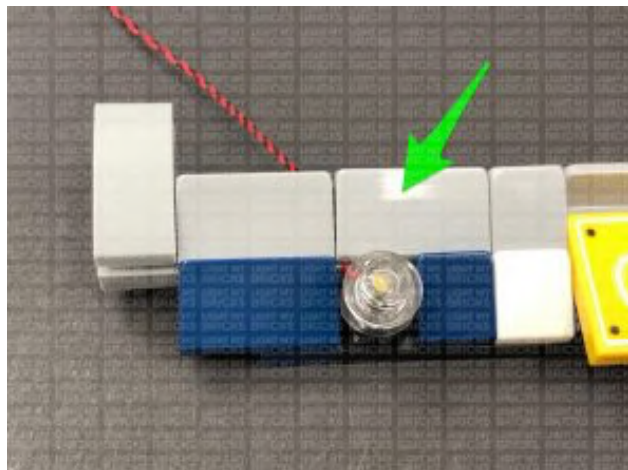
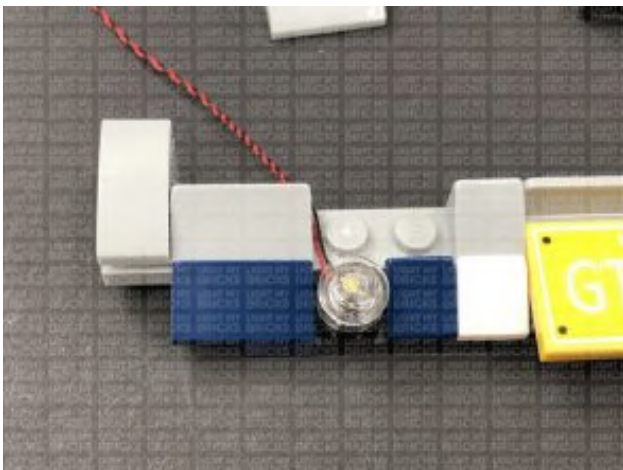
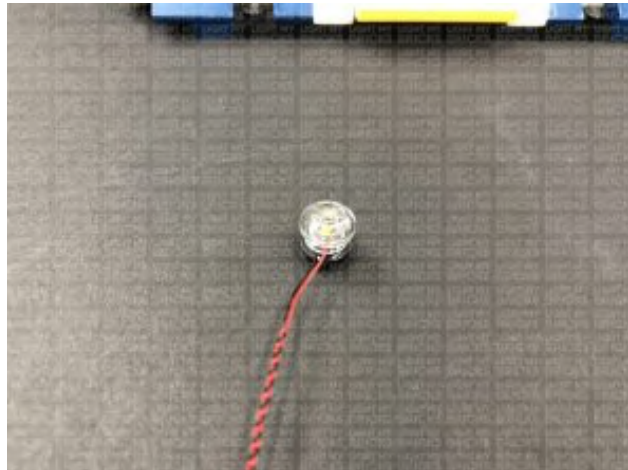

Repeat the above to install another **White 15cm Bit Light** to the other side of the bottom section securing it in place using another provided **Trans Clear Round Plate 1x1**.

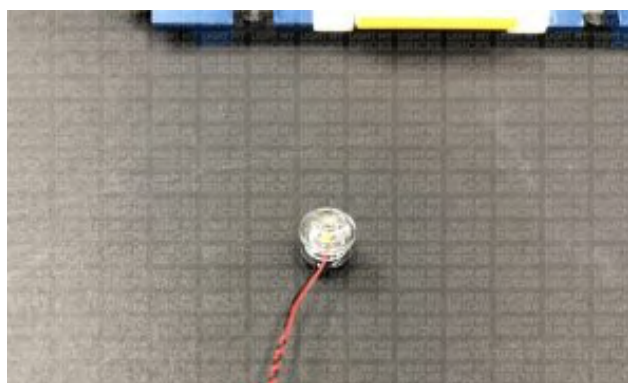
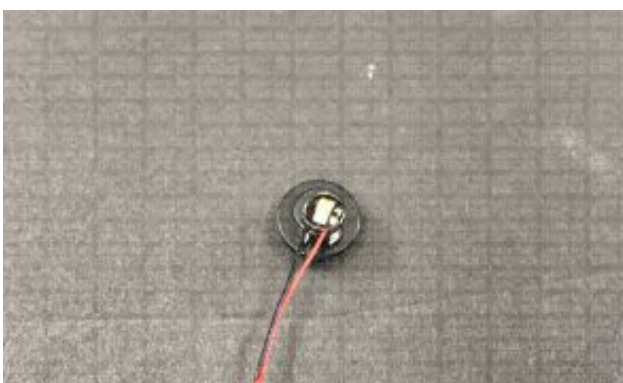

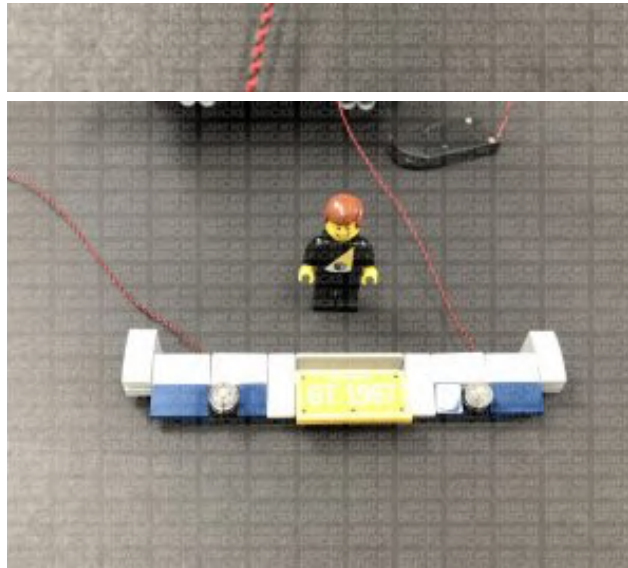
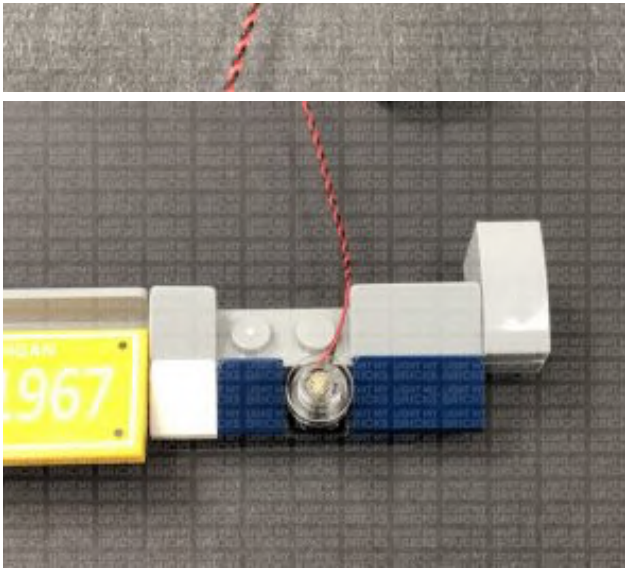

21.) Reconnect the bottom section to the back of the vehicle, then lay each cable underneath the blue tile on each side as shown below:

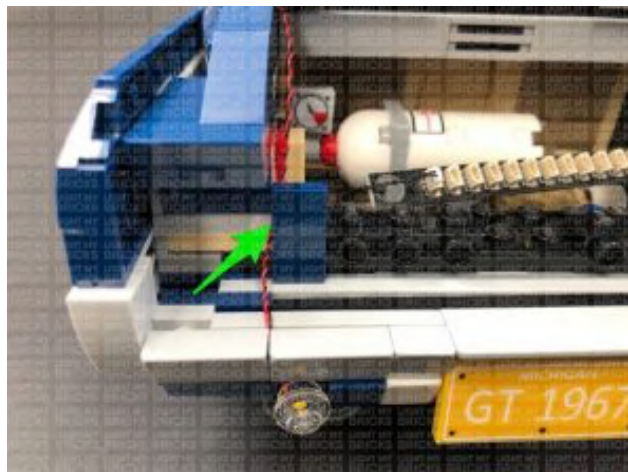
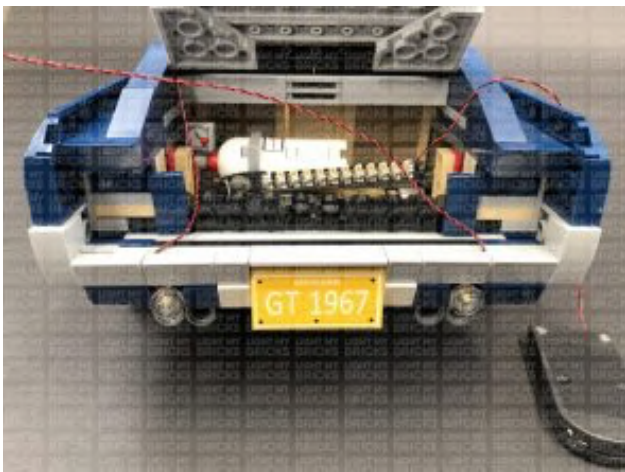



Connect both Bit Light cables to the 12-port Expansion Board, then turn the battery pack ON to test the two back lights are working OK.

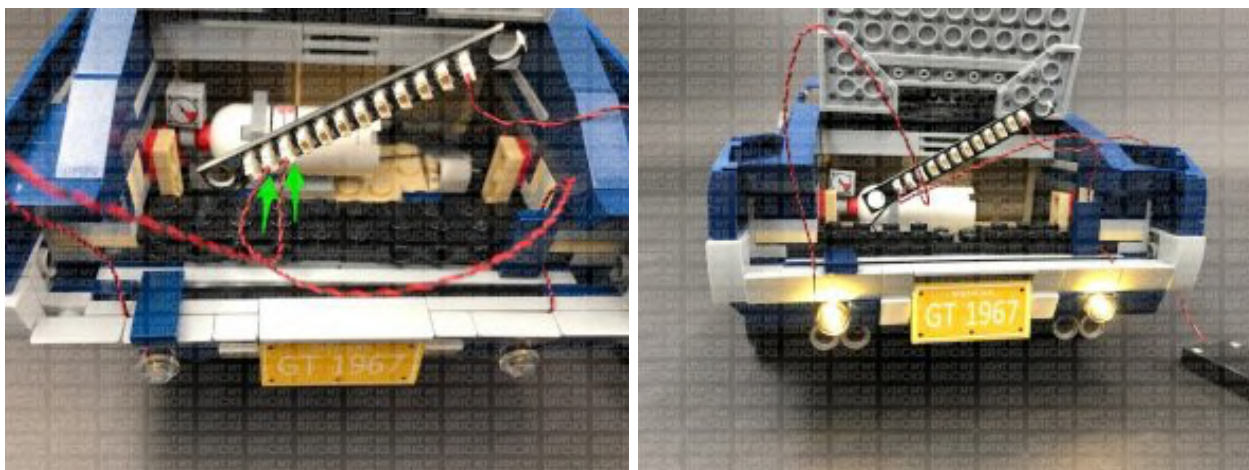

*Note: If you experience any issues with the lights not working and suspect an issue with a component, please try a different port on the expansion board to verify where the fault lies (with the light or expansion board). To correct any issues with expansion board ports, please view the section addressing expansion board issues on our **online troubleshooting guide**.*

**22.)** Take the following tail light sections and disassemble the left tail light section as shown below:



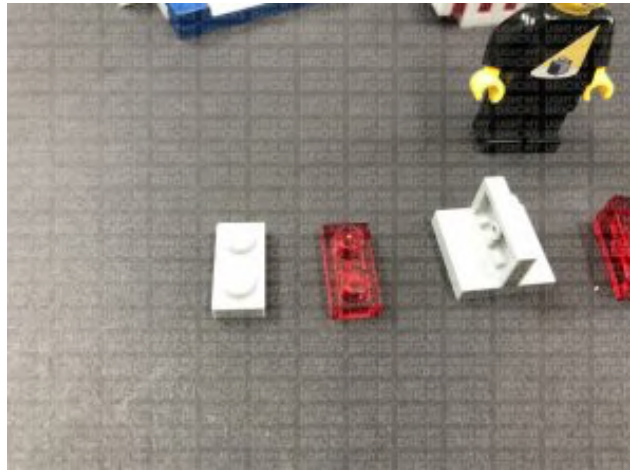
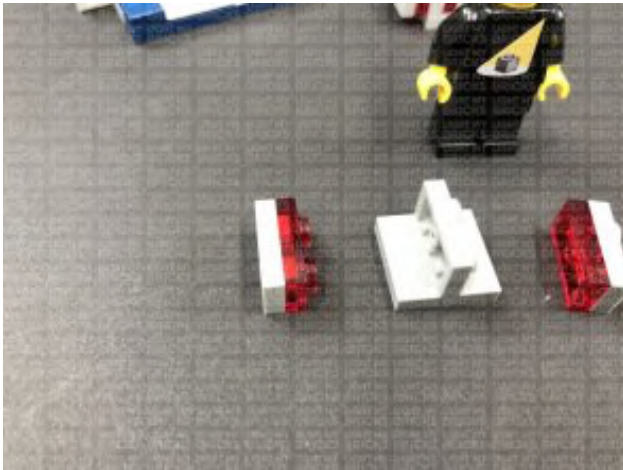
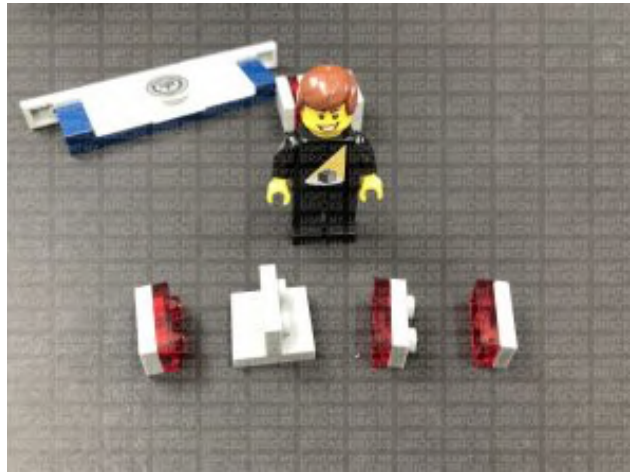
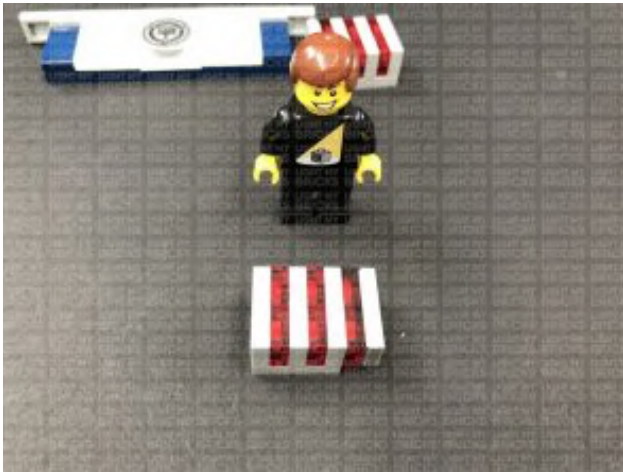

Take a **White 15cm Bit Light** and with the cable facing up and to the right, place it over the bottom stud on the light grey 1x2 tile. Secure it in place by reconnecting the trans red 1x2 plate over the top, then reconnect this to the light grey 1x2 plate with vert. tube (t-shaped plate).

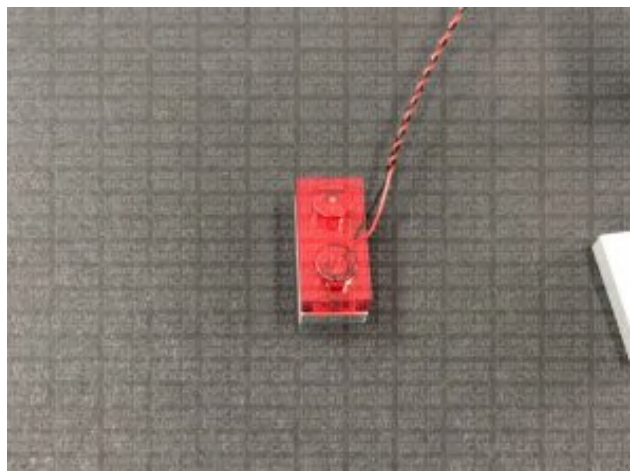
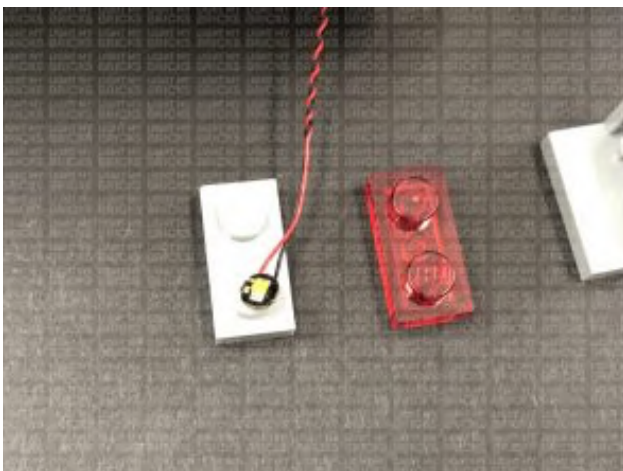



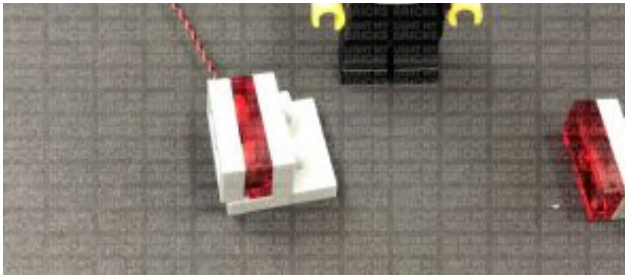

22.) Using the above process and following the below images, install another **2x White 15cm Bit Lights** to the left tail light section.

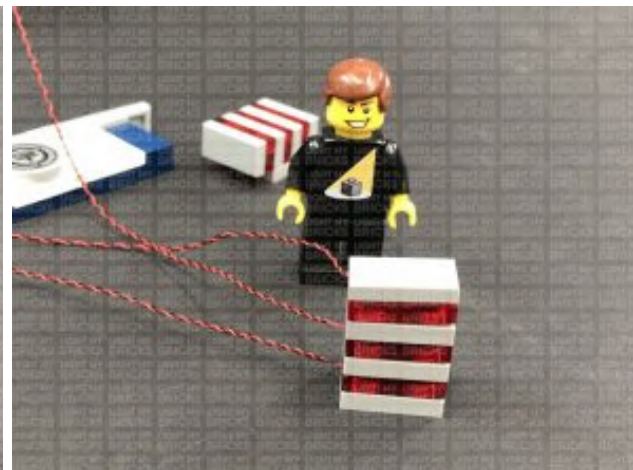
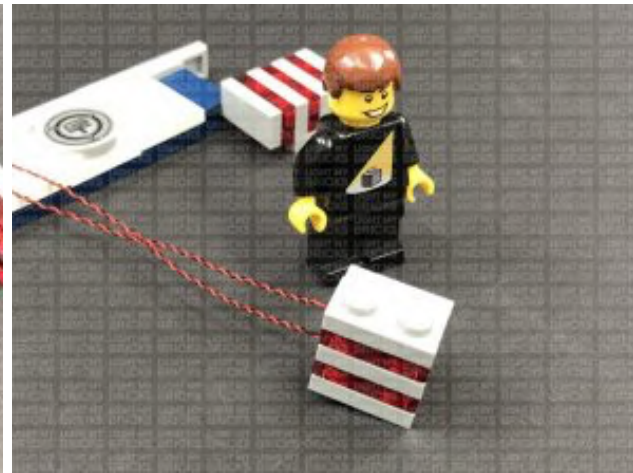
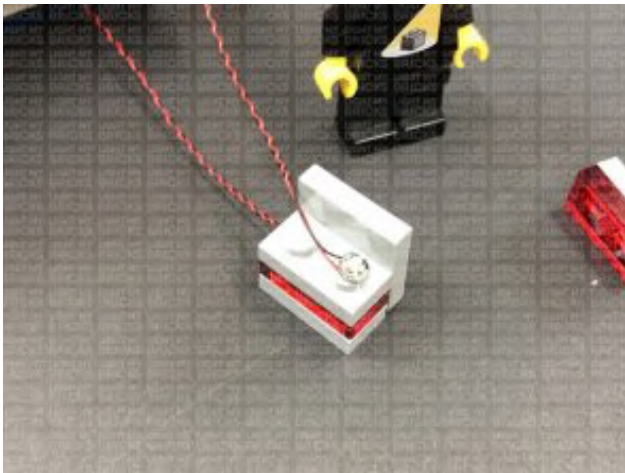

23.) Twist/wind the three cables around each other all the way to the ends so they come together to form one larger cable.

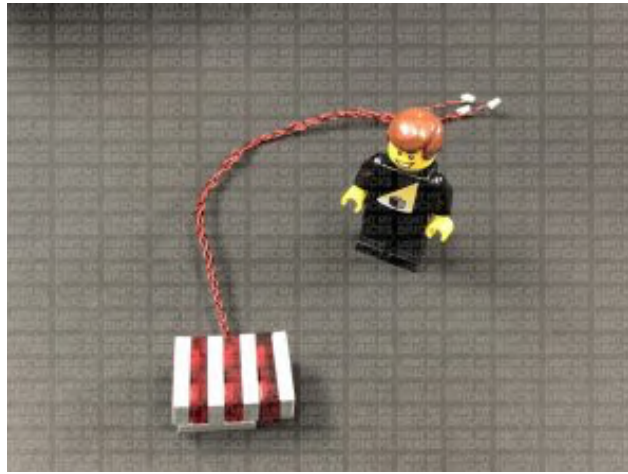
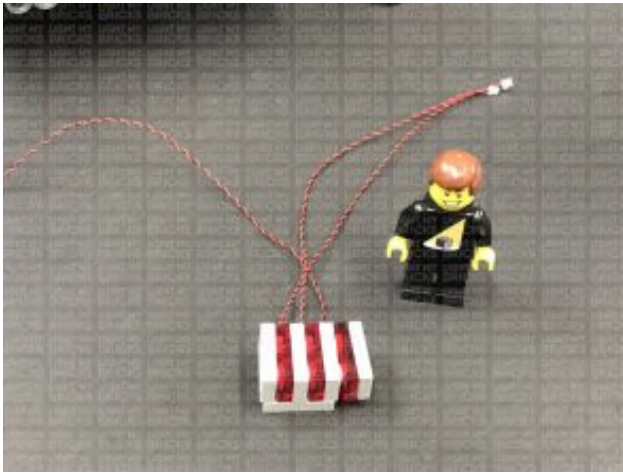

Reconnect this section to the back of the vehicle ensuring you first thread the cable in behind and out to the right side. Connect the three Bit Lights to the 12-port Expansion Board, then turn the battery pack ON to test the left tail lights are working OK.

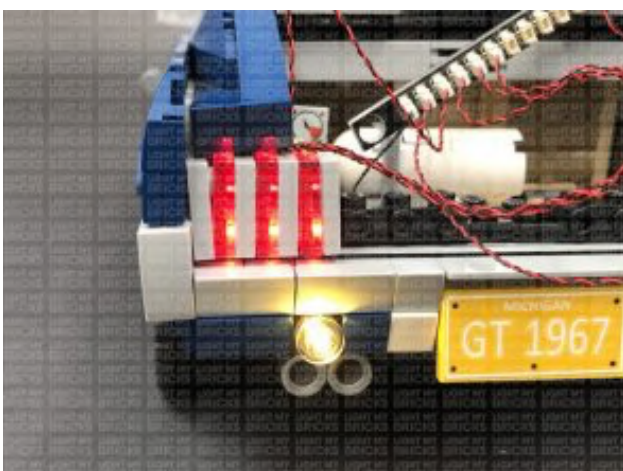
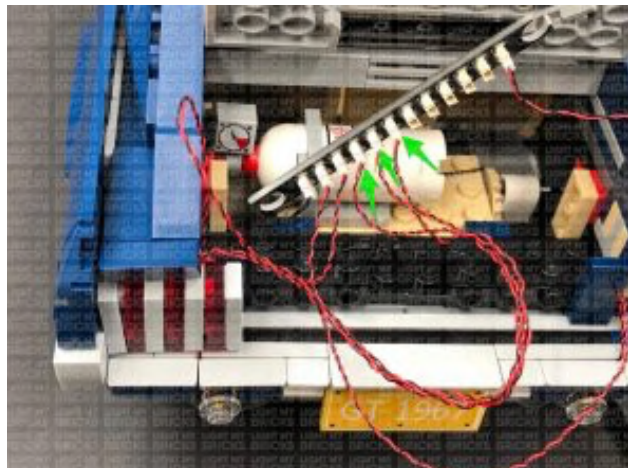
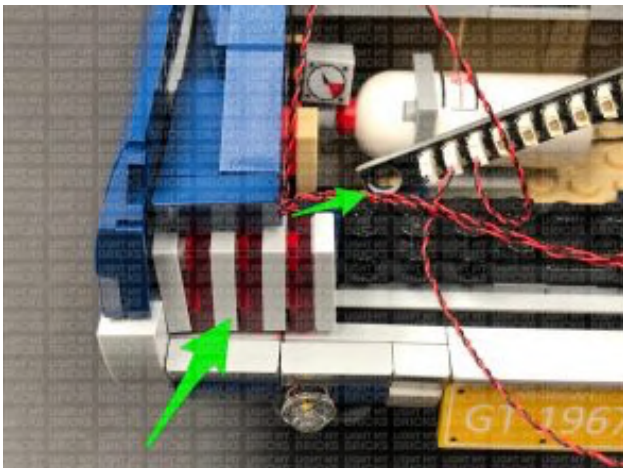

*Note: If you experience any issues with the lights not working and suspect an*



issue with a component, please try a different port on the expansion board to verify where the fault lies (with the light or expansion board). To correct any issues with expansion board ports, please view the section addressing expansion board issues on our **online troubleshooting guide**.

24.) Repeats step 22-23 to disassemble the right tail light section and install **3x White 15cm Bit Lights** to it, then twist/wind the cables around each other.

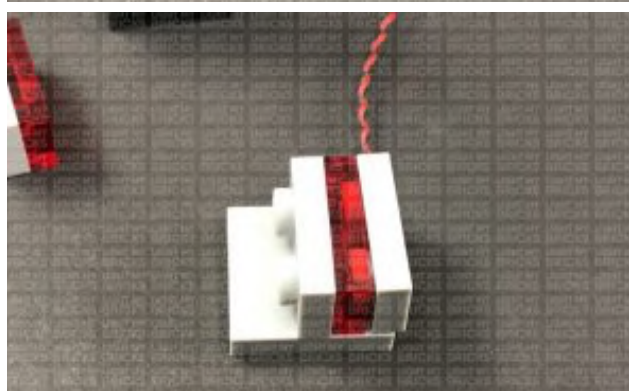
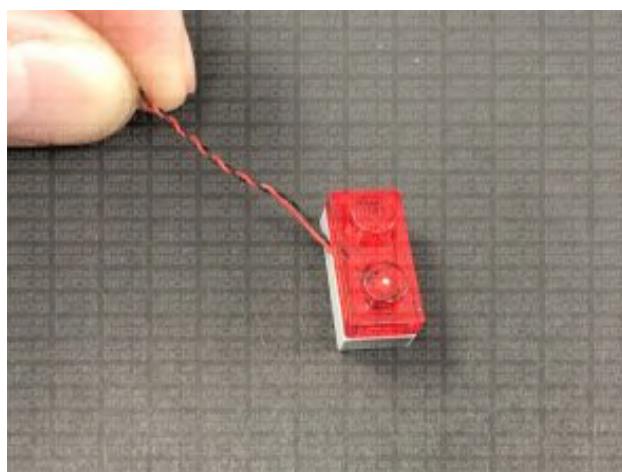
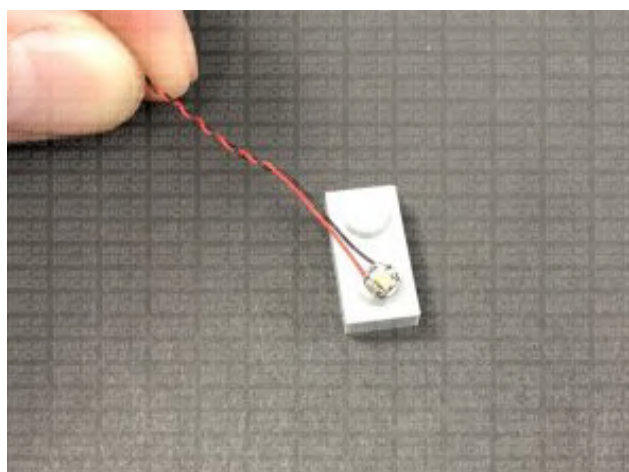
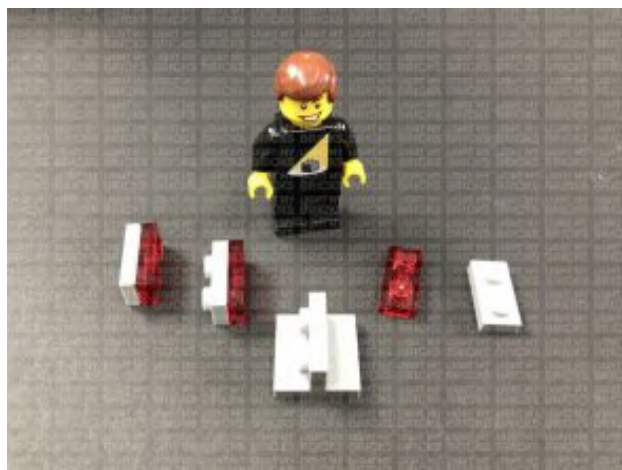
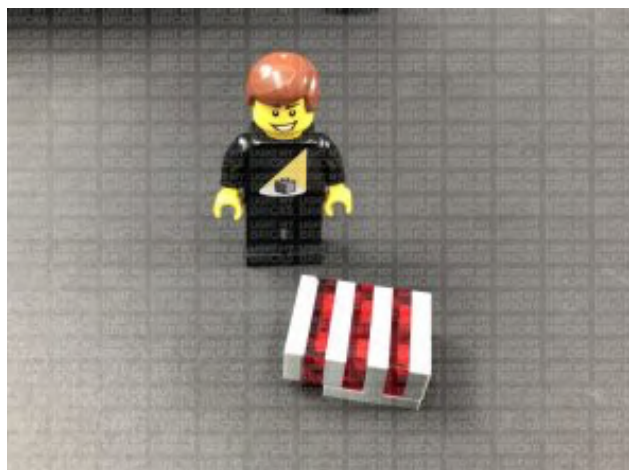

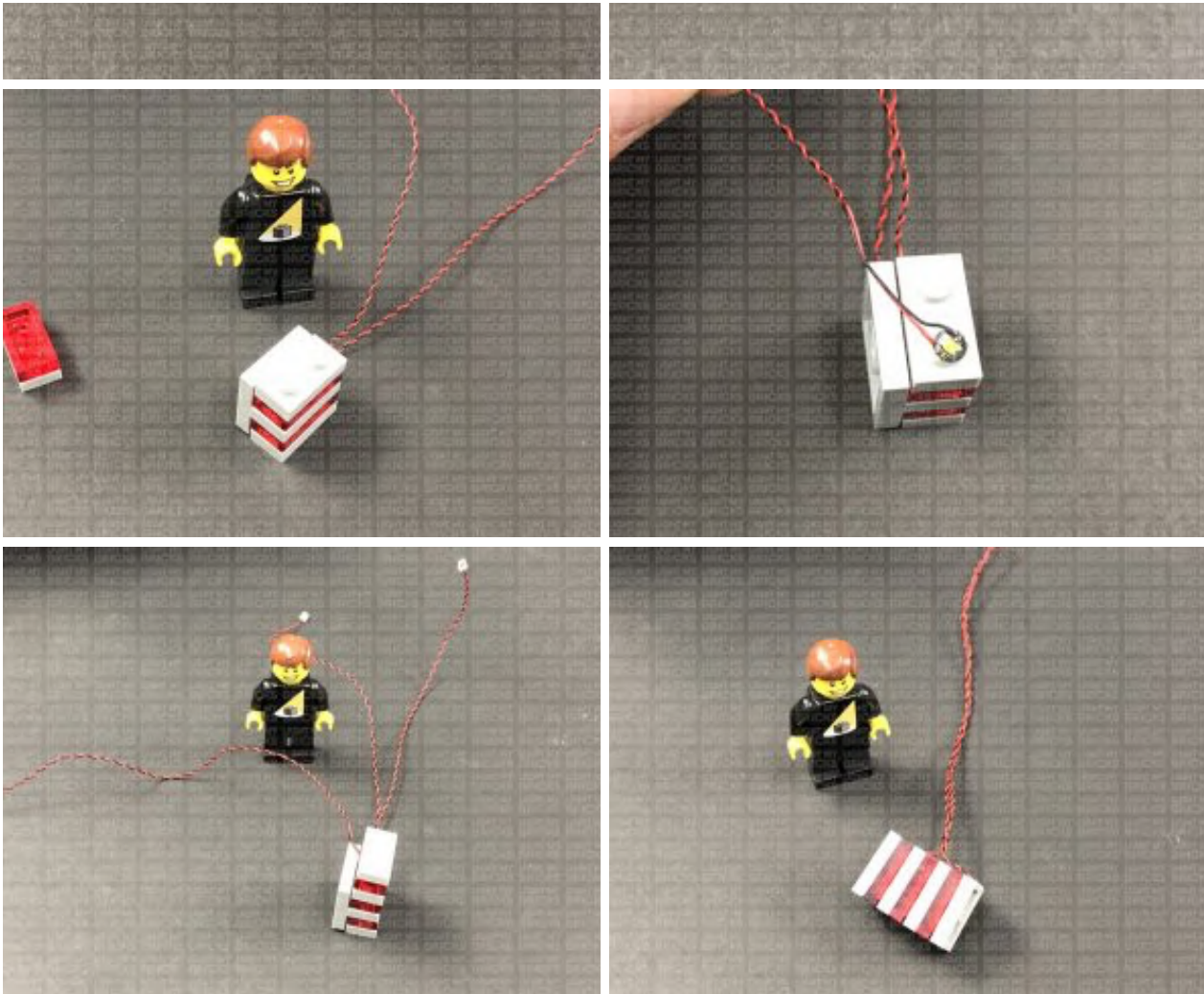

25.) Reconnect this section to the back of the vehicle ensuring you first thread the cable in behind and out to the left side. Connect the three Bit Lights to the 12-port Expansion Board, then turn the battery pack ON to test the right tail lights are working OK.

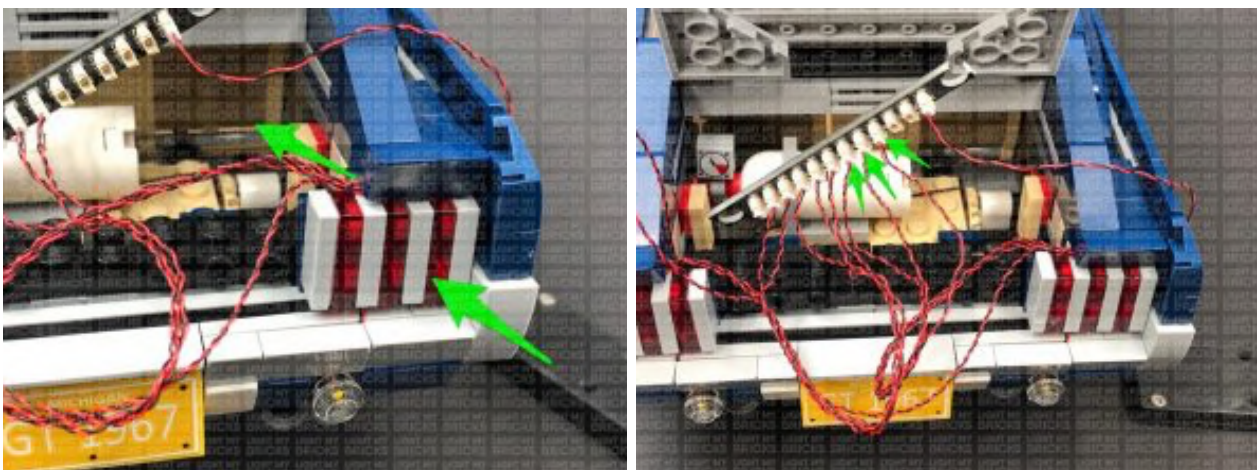



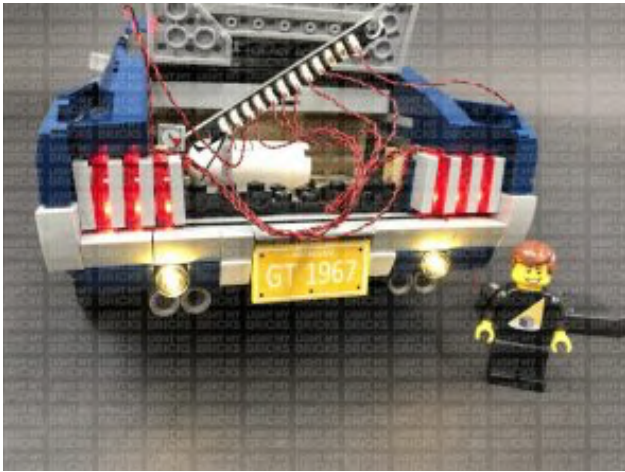

Pull the cables from each side inside the boot, then reconnect the remaining back section we removed earlier.

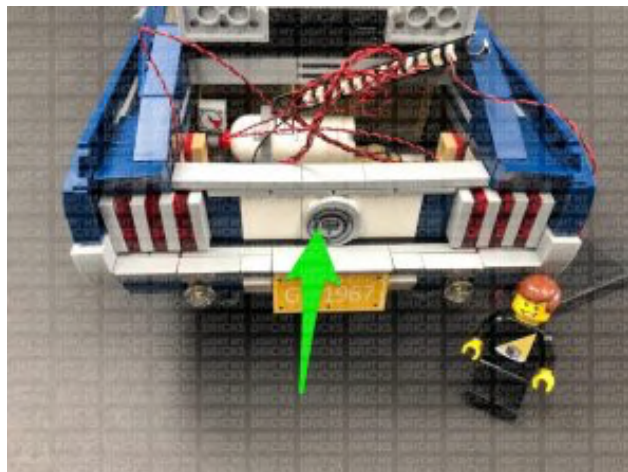
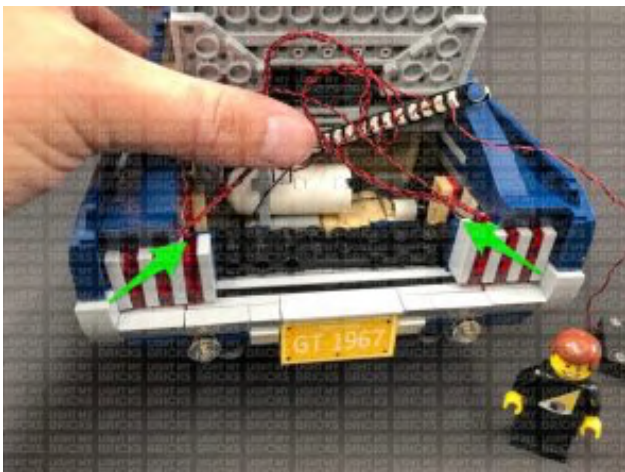

Twist and fold the excess cables around each other into a neat bunch before placing everything neatly inside the boot, then place the battery pack on top before closing the boot.

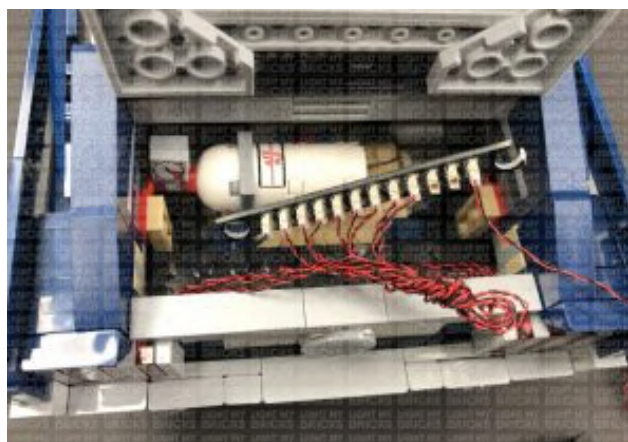
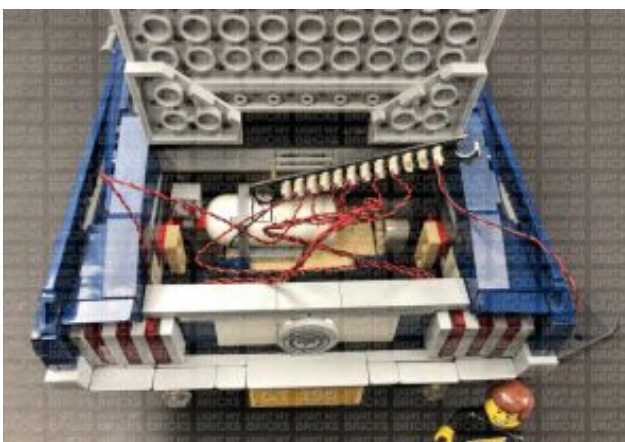

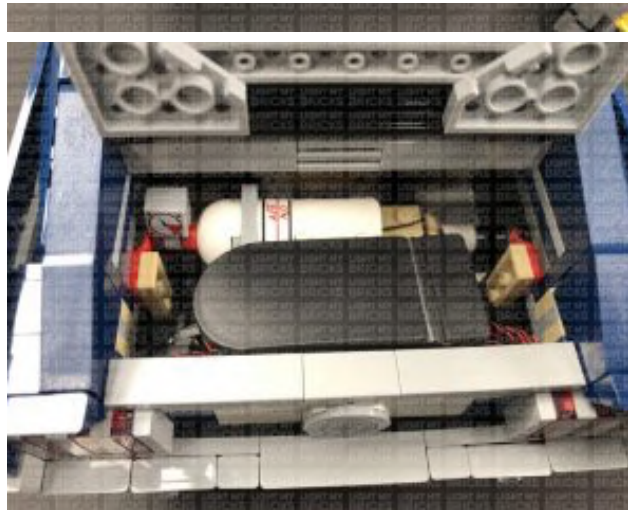
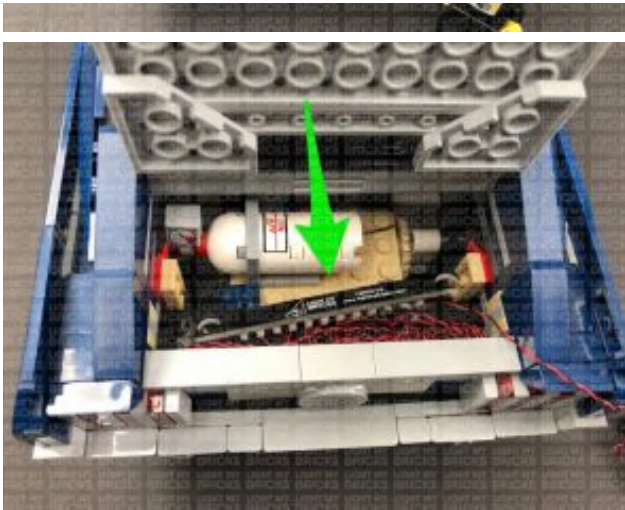

Congratulations, this finally complete's installation of your Light My Bricks Ford Mustang Light Kit. We thank you for purchasing this product and hope you enjoy!

