

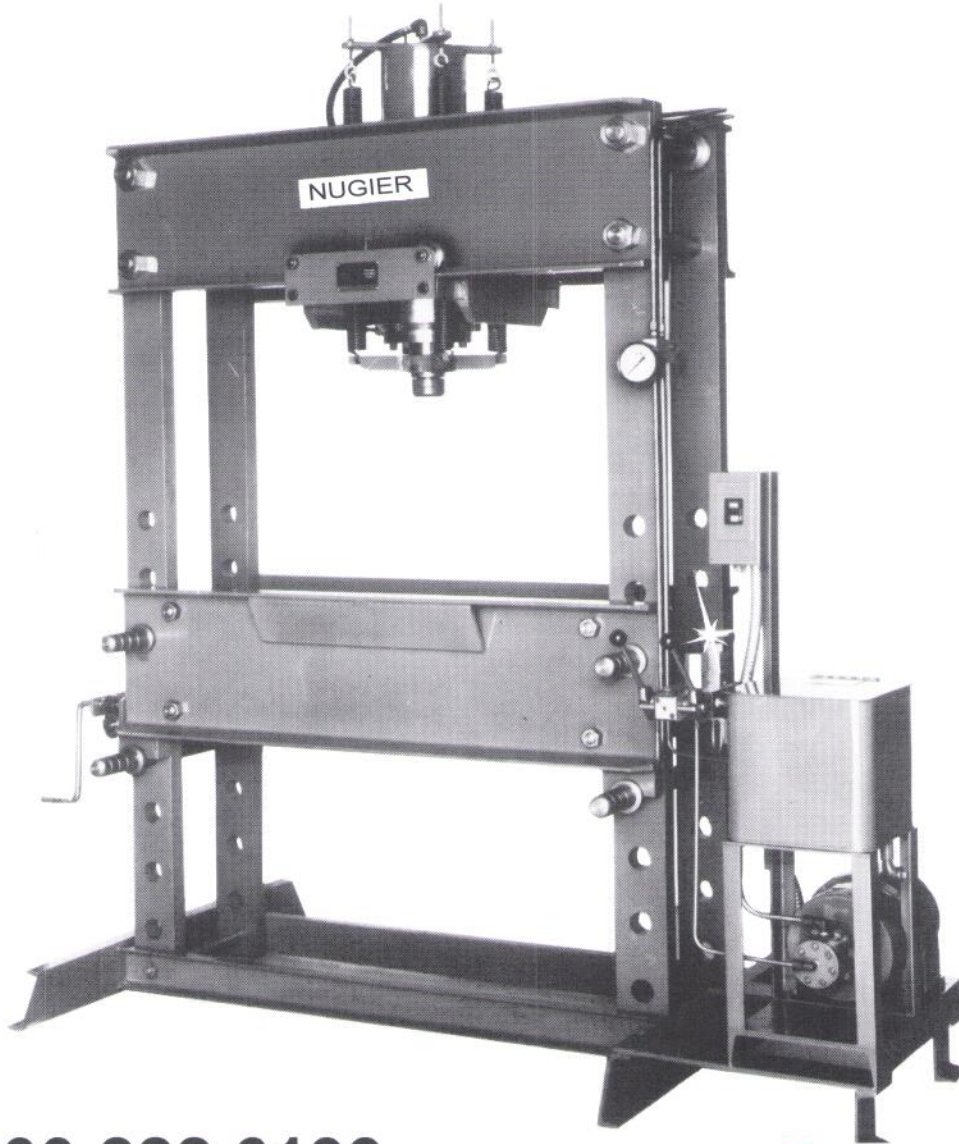

# **NUGIER** BRAND

## **H-FRAME HYDRAULIC PRESSES**

**50**  
YEARS OF  
EXCELLENCE  
1944-1994



**800.222.6199**



**THE CARLSON COMPANY**

*Your Source For Professional Service Equipment*

PO Box 80897 Rancho Santa Margarita, CA 92688  
800-222-6199 • 949-768-3333 • Fax 949-768-3336  
[www.thecarlsoncompany.com](http://www.thecarlsoncompany.com)

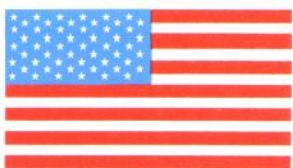

**PROUDLY  
MADE IN  
U.S.A.**

*A COMPLETE LINE OF STANDARD  
H-FRAME PRESSES, 20 TO 300 TON.  
HAND, AIR OR MOTOR OPERATED.*

# Nugier Press Company, Inc.

Your source for Nugier Brand hydraulic presses & replacement parts

Nugier Press Company, Inc. offers the full line of **NUGIER** brand hydraulic presses, a name associated with the highest in quality, durability and dependability for over 50 years. Known as the 'workhorse' of hydraulic presses, they are heavy-duty constructed with long life usage in mind. Reasonably priced, these presses will easily pay for themselves and offer years of maintenance free operation.

## Standard Features for Nugier brand H-frame Presses:

- Heavy-duty rigid steel frame** built for years of rugged and dependable use.
- Adjustable table** permits for a wide selection of daylight openings.
- Self-locking table winch** is mounted on outside of press frame eliminating obstruction.
- Movable cylinder** is designed to give maximum side movement across the workhead (except 20 & 25 ton).
- Pressure gauge** is high precision, liquid fillable, stainless steel cased and is calibrated in tons and psi.
- Two table blocks** with V grooves provide for various pressing applications.
- Flat ram nose** of hardened steel (V-ram nose optional).
- Preassembled**, our presses are delivered standing, ready to operate.



**THE CARLSON COMPANY**

Your Source For Professional Service Equipment

PO Box 80897 Rancho Santa Margarita, CA 92688  
800-222-6199 • 949-768-3333 • Fax 949-768-3336

[www.thecarlsoncompany.com](http://www.thecarlsoncompany.com)

**3 YEAR  
Warranty**

## 3 Year Warranty

Backing up the name of **Nugier** brand presses is a 3 year warranty, 2 years longer than the next nearest competitor. We warrant our products to be 1st in quality, durability and dependability for 36 months from date of shipment to customer. Also offered reasonably priced, is a 2 year extended warranty giving 5 years of warranty protection.

## Modified Standard Presses

If a standard press doesn't fit your specialized applications, we will gladly modify it for you. From specific frame size, tonnage or operator requirements. Nugier Press Company has the experience and capability to meet your needs. Call us with your requirements, we are committed to customer satisfaction.

## 20 Ton Hand Operated Hydraulic Press

This is our small but sturdy 'workhorse' 20 ton hydraulic press. Designed for hand or foot pump operation this press comes with a calibrated pressure gauge, table winch, ram nose and table parallels. One or two speed hand pumps are available for this press.

### H20-6 Specifications:

Capacity	20 tons
Ram travel	6 "
Width between uprights	24 "
Width between table rails	5 "
Maximum daylight (ram to table)	37 "
Ram diameter	2 1/4 "
Floor space	31" x 30 "
Shipping weight (lbs.)	265

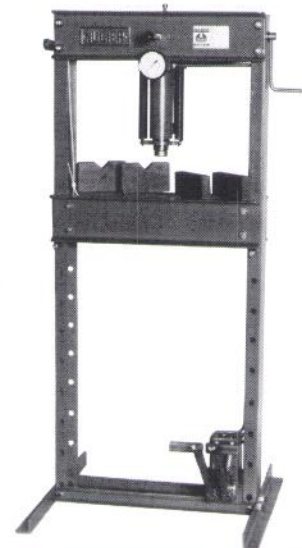

# 25 to 300 Ton Presses: Hand, Air or Electric operated.

## Hand Operated Hydraulic Press

Our hand operated presses feature a two speed, single handle pump for rapid ram advance and convenient operation. Very durable, our hand pump is rated over 10,000 psi with fast flow capability and large reservoir capacity. When operating the pump, the ram will advance rapidly to the work piece then develop high pressure by switching the pressure knob.

Listed below are handle pumping strokes required to move the ram one inch of travel for the given press size (tonnage).

Size	Handle strokes per inch of ram travel						
	25	40-50	60-80	100	150	200	300
Strokes	2	3	7	6	8	10	16

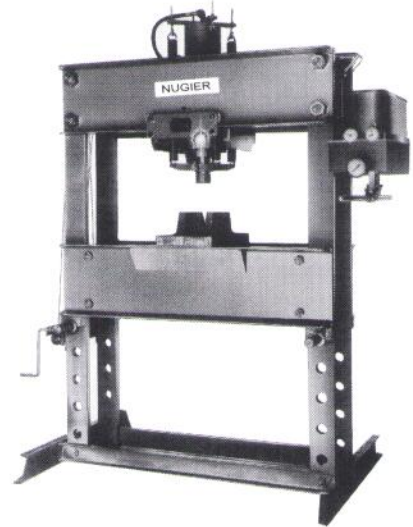

## Air Operated Hydraulic Press

Our air operated presses feature the Nugier patented double acting air powered hydraulic pump. The pump will deliver high speed flow with virtually no pulsation, giving you the smoothest ram movement in all air presses in the market today. This unit is known to give years of reliable, trouble-free operation.

**Standard features** on this air package include:

- Blow down lever** for rapid advance of ram.
- Hand and foot controls** combined on the press for operator convenience.
- Air filter/regulator** with psi gauge provided.

Size	Ram Speeds-inches per minute at 100 psi air						
	25	40-50	60-80	100	150	200	300
Advance	28"	13"	9"	6"	4.5"	3.5"	2.5"
Press	3"	3"	2"	1"	.5"	.3"	.2"

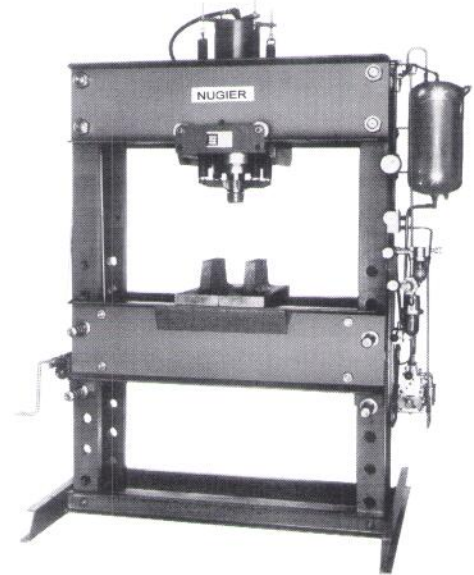

## Electric Motor Operated Hydraulic Press

For our electric motor operated presses, we use a heavy-duty hydraulic pump and motor package that is designed for continuous high volume usage. A **single-acting** spring return or **double-acting** power return cylinder system may be selected. Depending on speed requirements a single or dual pump package will be provided.

Size	Ram Speeds-inches per minute						
	25	40-50	60-80	100	150	200	300

### MD7.5 (7.5 Horsepower:Single-acting cylinder)

Advance	58"	20"	17"	11"	8"	6"	5"
Press	24"	10"	8"	5"	4"	3"	1"

### MD7.5 HVPR (7.5 Horsepower:Double-acting cylinder)

Advance	340"	190"	100"	70"	54"	40"	26"
Return	700"	400"	182"	100"	72"	53"	35"

Optional: a **MD10** (10 H.P.) powerplant may be ordered.

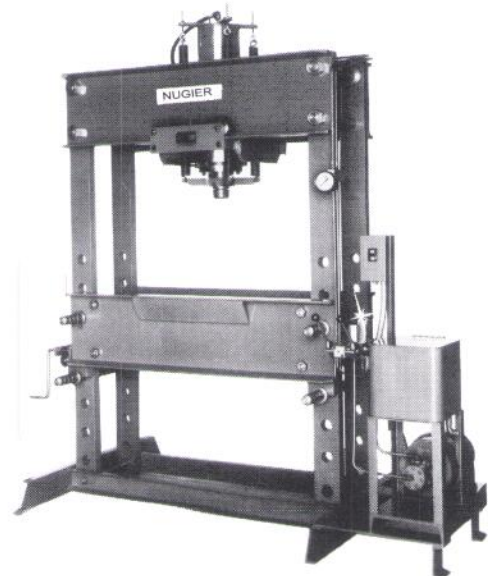

## Press Frame Dimensions: 25 thru 300 ton H-frame

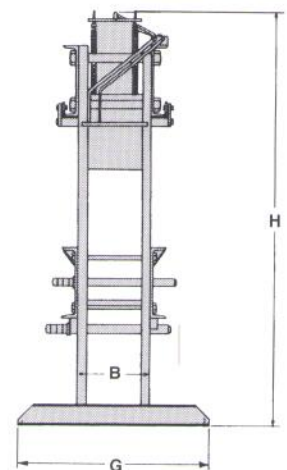
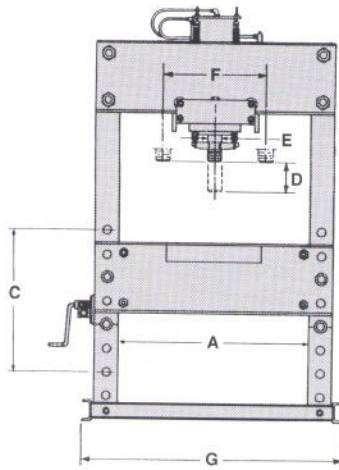
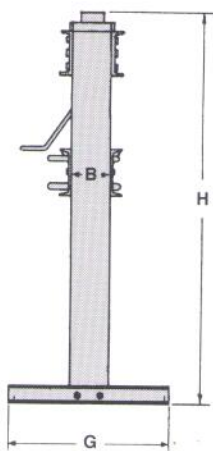
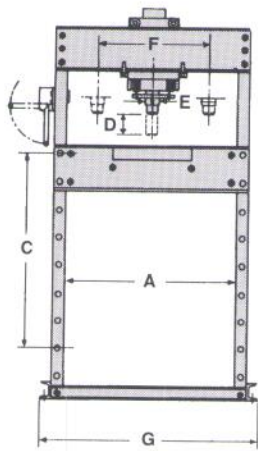

Models: H25 H40 H50

H60 H80 H100 H150 H200 H300

Press Size (tons)	25	40	50	60	80	100	150	200	300
<b>A</b> Inside width	30"	30"	34"	40"	48"	48"	48"	48"	54"
<b>B</b> Width between table rails	7 1/2"	7"	7"	8"	8"	15"	16"	18"	16"
<b>C</b> Table travel	36"	36"	36"	36"	32"	30"	30"	30"	36"
Maximum ram to table	40"	41"	41"	42"	41"	36"	36"	41"	54"
<b>D</b> Ram travel	7"	14"	14"	14"	14"	14"	14"	14"	14"
<b>E</b> Ram diameter	2 1/4"	2 3/4"	2 3/4"	3 1/4"	3 1/4"	3 1/4"	3 1/2"	3 3/4"	5"
<b>F</b> Cylinder travel	none	21"	24"	26"	34"	31"	30"	26"	30"
<b>G</b> Press base	39"x30"	39"x30"	43"x30"	51"x39"	58"x39"	63"x48"	63"x48"	65"x48"	72"x60"
<b>H</b> Height	74"	82"	82"	83"	85"	99"	99"	104"	120"
Weight* (lbs.)	485	622	650	1147	1210	2660	3090	3920	5450

\* Add 50 lbs. to each press weight for Air Operated and 200 lbs. for Motor Operated.

### Additional products by Nugier Press Company, Inc.

Please inquire for information on our other product lines and services:

- Automotive tooling and accessories    -Standard and custom press accessories    -Custom H-frame
- Roll H-frame presses    -Movable table presses    -C-frame presses    -Guided platen presses
- Horizontal frame presses    -Heated platen presses    -Parts and service for all Nugier brand Presses



18031 La Salle Avenue. • Gardena, CA 90248

DISTRIBUTED BY:



PO Box 80897 Rancho Santa Margarita, CA 92688  
 800-222-6199 • 949-768-3333 • Fax 949-768-3336  
[www.thecarlsoncompany.com](http://www.thecarlsoncompany.com)