

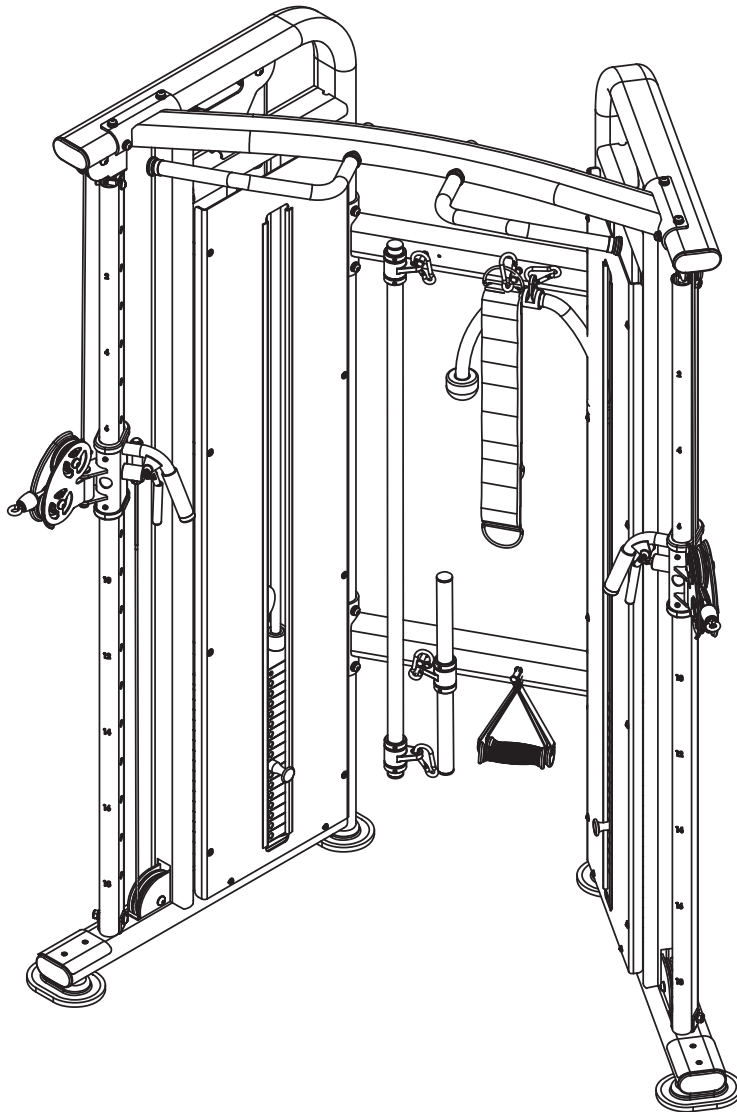

**56000 SILVER
STRENGTH TRAINING SERIES FUNCTIONAL CABLE CROSSOVER
OWNER'S MANUAL**



BEFORE YOU START

PLEASE READ THIS INSTRUCTION MANUAL BEFORE YOU BEGIN ASSEMBLY. Great care has been taken to design these instructions and following them will help you with quicker assembly and minimize the risk of injury.

It is important that you keep these instructions for future reference.

This list is not exhaustive - You are responsible for your own safety!

- Assemble the product on a level surface
- You will need at least one person to help you assemble this unit.
- Always use the product on a level surface, ensure that the product is stable before use.
- Always ensure that the equipment has adequate space on each side and front (the back can be near to a wall).
- Replace defective components immediately, and/or keep the equipment out of use until it is repaired.
- Use only the adjustment settings as described in the instructions. Always use the correct adjustment pin and/or locking devices.
- Always check that any pins / fixings are tight and secure before use and / or after adjustment.
- Never leave any adjustment devices projecting from the product.
- Always consult your doctor before undertaking any exercise program.
- Always wear suitable clothing and footwear e.g. tracksuit / shorts / training shoes
- Remove all personal jewelry before exercising.
- Ensure you warm-up well before using the equipment as this will help to prevent muscle strain.
- Injuries to health may result from incorrect or excessive training.
- We recommend that you do not lift weights alone. There should be somebody there to assist you.
- Never use the equipment in any other manner other than the ways explained in these instructions and/or any wall-chart supplied.
- Parents and others in charge of children should be aware of their responsibility, because the natural play instinct and the fondness of experimenting of children can lead to situations and behavior for which the training equipment is not intended.
- If children are allowed to use the equipment, their mental and physical development and above all their temperament should be taken into account. They should be controlled and instructed in the correct use of the equipment.
- The equipment is under no circumstances suitable as a children's toy.
- Children should not be allowed on, or around the equipment - especially when it is not in use.
- Due to our continuous policy of product development, York Barbell reserves the right to change specifications without notice.

CAUTION! The instructions must be followed carefully in the assembly, use and maintenance of your equipment. The warranty does not cover damage due to negligence of the assembly, adjustment and maintenance instructions described herein.

THIS PRODUCT IS NOT SUITABLE FOR THERAPEUTIC PURPOSES.

TOOLS AND CONSUMABLES

- 1 x 1/4" - Socket Head Wrench / Spanner
- 1 x 2.5mm - Socket Head Wrench / Spanner
- 1 x 4mm - Socket Head Wrench / Spanner
- 1 x 5mm - Socket Head Wrench / Spanner
- 1 x 6mm - Socket Head Wrench / Spanner
- 1 x 8mm - Socket Head Wrench / Spanner
- 1 x 10mm - Socket Head Wrench / Spanner
- 1 Philips Screwdriver

* Pliers should not be used!

CUSTOMER SUPPORT

Should you require any assistance regarding this product please gather the following information and then contact us using the details below:

- Serial No. - This can be found on the sticker below, located as indicated.
- Original purchase date
- Place of purchase
- Information about the place and conditions of use
- Precise description of the issue / defect

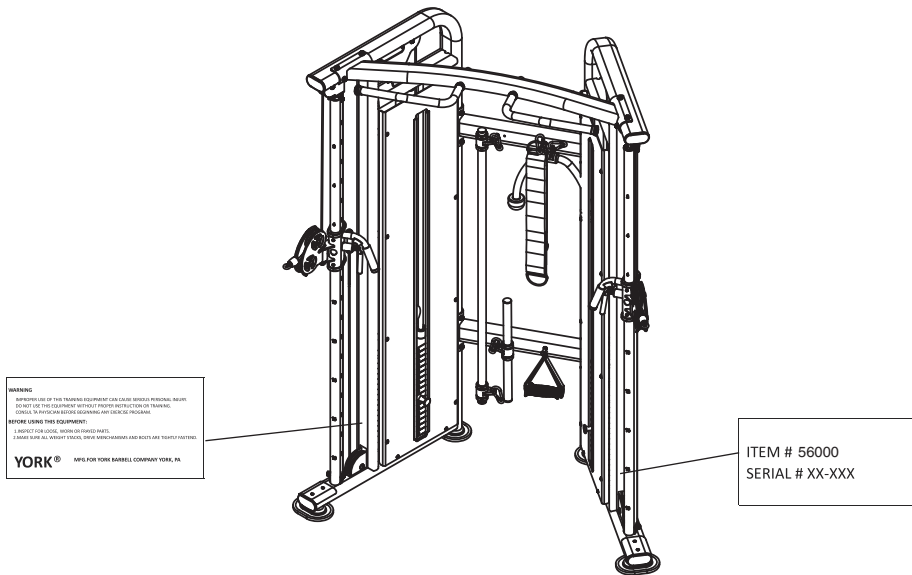

IMPORTANT!! - Please retain your sales receipt, York Barbell Customer Care may request proof of purchase to validate eligibility for warranty service. Warranty cover starts from the date shown on the proof of purchase.

CARE & MAINTENANCE

- Always place the equipment in a dry environment.
- Use a warm, damp cloth to keep the product clean.
- The safety level of the equipment can be maintained only if it is regularly examined for damage and wear at the start of every use. This includes any nuts, bolts, moving parts, bushes etc.
- Always replace damaged / worn components with original parts from the manufacturer.

PREPARE YOUR WORK AREA - It is important you assemble the product in a clean and uncluttered space.

WORK WITH A FRIEND - We recommend you have someone assist you with the assembly as some of the components are quite heavy.

UNPACK THE CARTON - Remove all the parts and lay them out on the floor.

CHECK TO MAKE SURE YOU HAVE ALL PART, NUTS, BOLTS... ETC, BEFORE YOU START ASSEMBLY.

IF YOU ARE MISSING ANY PARTS AND THE BOX WAS UN-OPENED WHEN YOU LEFT THE STORE, PLEASE CONTACT YORK CUSTOMER SERVICE via <http://yorkbarbell.com>.

PRE-ASSEMBLY CHECK LIST

Carton 1/1

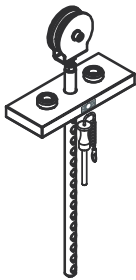

22 10LB Counter Weight Stack Set x 2PCS

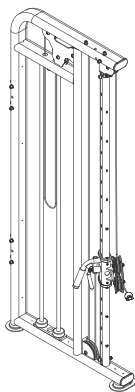

1 Left Upright Frame x1PC

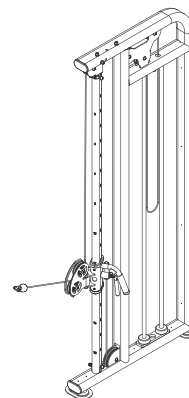

2 Right Upright Frame x1PC

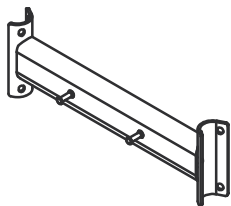

4 Lower Frame Connector x 1PC

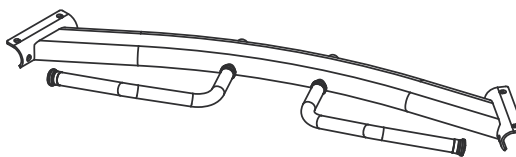

3 Frame Connector with Pull Up Station x1PC

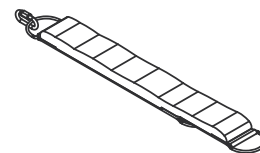

18 Ankle Strap x1PC

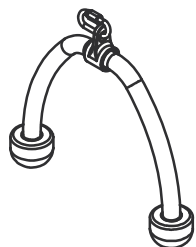

19 Tricep Rope x1PC

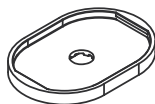

37 Rubber Foot-175x125x11mm x4PCS



69 Single Grip Attachment x2PCS

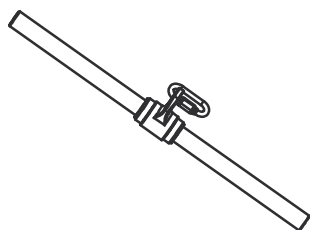

17 Short Bar x1PC

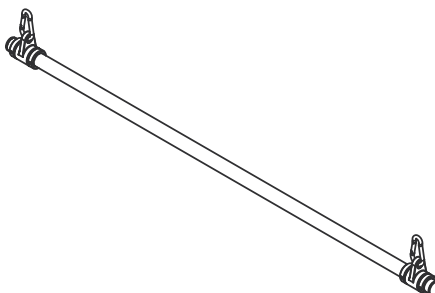

99 Long Bar x1PC

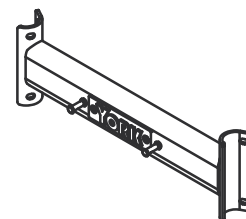

12 Middle Frame Connector x 1PC

EXPLODED DRAWING & PARTS LIST

<u>CHECK</u>	<u>ITEM</u>	<u>QTY</u>	<u>DESCRIPTION</u>
—	1	1	Left Upright Frame
—	2	1	Right Upright Frame
—	3	1	Frame Connector with Pull Up Station
—	4	1	Lower Frame Connector
—	6	2	Rotary Frame
—	7	2	Roller Hanger
—	8	1	Left Adjusting Pipe
—	9	1	Right Adjusting Pipe
—	10	4	Guide Rod -20x1726mm
—	11	2	Guide Rod Fixing Plate
—	12	1	Middle Frame Connector
—	13	4	Mounting Pole
—	14	4	Ringer
—	15	2	Shield
—	16	2	298-3/7"(7580MM) 4.8 Cable Set
—	17	1	Short Bar
—	18	1	Ankle Strap
—	19	1	Tricep Rope
—	21	32	10LB Weight Stack
—	22	2	10LB Counter Weight Stack Set
—	23	2	17 Holes Shaft
—	24	2	Select Pin
—	25	2	Spring Pin-10x45mm
—	26	5	Hoist Hook-7x66mm
—	27	4	Rolling Bearing -32x12x10mm
—	31	2	Pulley-114x25.8mm
—	32	14	Pulley-89x25.8mm
—	33	4	Hollow Pipe Sleeve
—	34	8	Rod End Cover
—	35	2	Handle Grip-31.5x24x490mm
—	36	4	Elliptical Tube Stopper -PT50x100x2mm
—	37	4	Rubber Foot-175x125x11mm
—	38	4	Rubber Bumper-62x20x26mm
—	39	2	Rubber Bumper-38x33x15mm
—	40	2	Plug-12.5x11.2x20mm
—	41	4	Blind Nuts-M8
—	42	2	Socket Cap Screw-M10x65mm
—	43	2	Socket Cap Screw-M10x55mm
—	44	2	Hex Nut-M12
—	45	4	Umbrella Head Hexagon Socket Screw-M10x45mm

EXPLODED DRAWING & PARTS LIST

<u>CHECK</u>	<u>ITEM</u>	<u>QTY</u>	<u>DESCRIPTION</u>
—	46	22	Socket Cap Screw-M10x25mm
—	47	4	Umbrella Head Hexagon Socket Screw-M8x25mm
—	48	2	Socket Cap Screw-M12x90mm
—	49	14	Umbrella Head Hexagon Socket Screw-M10x50mm
—	50	2	Umbrella Head Hexagon Socket Screw-M8x20mm
—	52	40	Cross Recessed Pan Head Tapping Screw-ST4.2x16mm
—	53	4	Flat Washer-24x13x2.5mm
—	54	66	Flat Washer-20x10.5x2mm
—	55	4	Big Washer-24x8.4x2mm
—	56	40	Big Washer-15x5.3x1.2mm
—	57	22	Spring Washer-M10
—	58	8	Spring Washer-M8
—	59	22	Nylon Insert Lock Nut-M10
—	60	2	Nylon Insert Lock Nut-M12
—	65	20	L Shape Plate
—	66	2	Front Shield
—	69	2	Single Grip Attachment
—	71	2	Rings Components
—	72	2	Hook Cover
—	73	2	Aluminum End Cover-38x6.5x13mm
—	74	2	Aluminum Ring-32x23x14.5mm
—	75	2	Aluminum Baffle Ring-35x26x13mm
—	76	2	Plastic Ring-30x26x4.5mm
—	77	2	Socket Cap Screw-M6x25mm
—	78	2	Spring Washer-M6
—	79	4	Inner Hexagon End Set Screw-M5x5mm
—	80	4	Reinforcing Regula-16x9x1560mm
—	81	4	Countersunk Head Pull mandrel Rivet-5x12mm
—	82	2	Protect Plate
—	83	1	Right Sliding Frame
—	84	1	Left Sliding Frame
—	85	2	Select Adjusting Frame
—	86	2	Adjusting Bar
—	88	2	Aluminum End Cover-32x6.5x12mm
—	89	2	Spring-1.4x12.5x38mm
—	90	2	Handle Grip Cover-31.5x24x490mm
—	91	2	Handle Grip Cover-18x12x100mm

EXPLODED DRAWING & PARTS LIST

<u>CHECK</u>	<u>ITEM</u>	<u>QTY</u>	<u>DESCRIPTION</u>
—	92	2	Roller Link 08A
—	93	2	Countersunk Head Hexagon Screw-M6x20mm
—	94	2	Reed Nut-M6x20.8x10mm
—	95	2	Elliptical Pipe Plug-PT50x100x3mm
—	96	8	Cross Recess Pan Head Screw-M4x10mm
—	97	8	Spring Washer-M4
—	98	8	Plain Washer-9x4.3x0.8mm
—	99	1	Long Bar
—	100	1	York Nameplate
—	101	1	Warning Lable
—	102	1	Warranty Card
—	103	1	Serial # Sticker
—	104	1	Hardware Card
—	105	1	Assembly Instruction

EXPLODED DRAWING & PARTS LIST

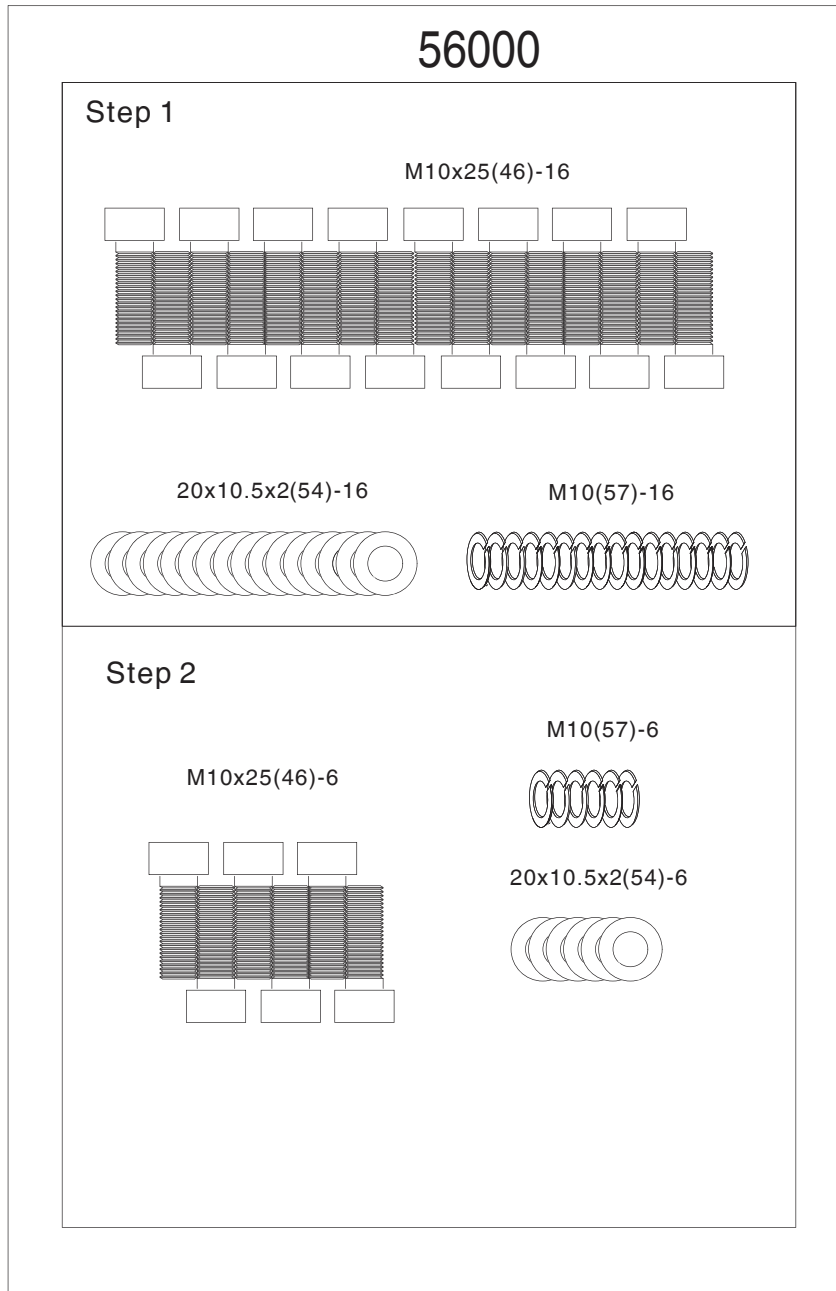



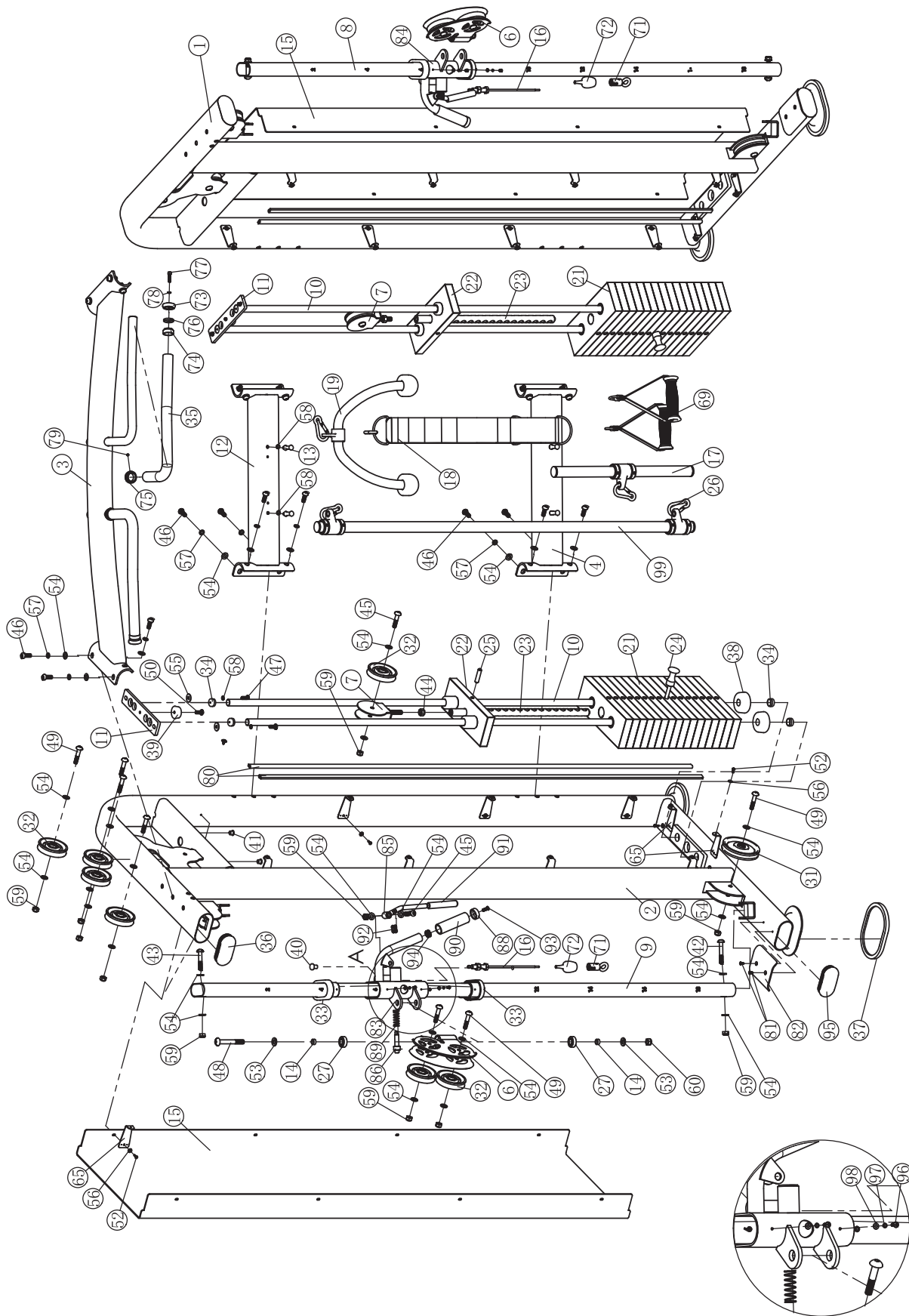





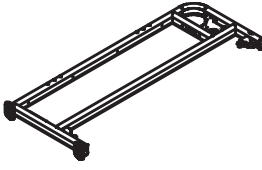
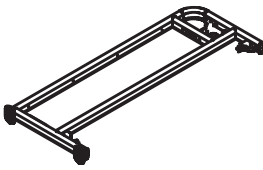
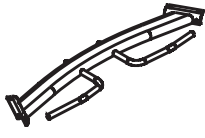
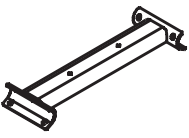

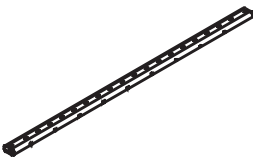
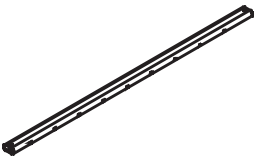
EXPLODED DRAWING & PARTS LIST

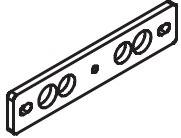
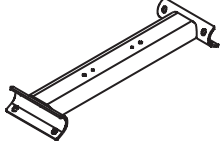

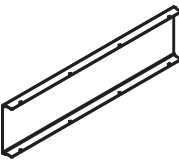

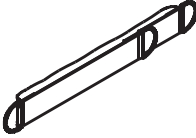

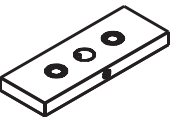
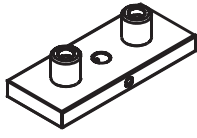
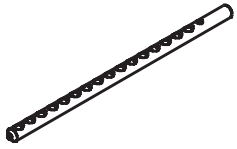



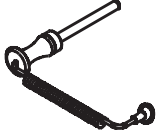
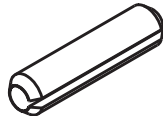
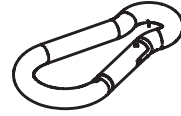





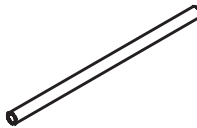

A
(1 : 5)

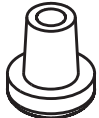

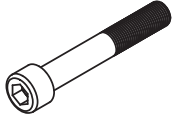
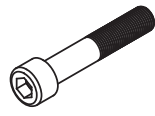
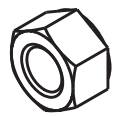







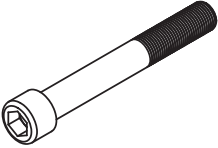







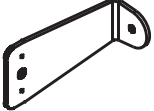
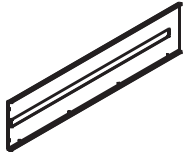

EXPLODED DRAWING & PARTS LIST

	1 Left Upright Frame 1PC		2 Right Upright Frame 1PC		3 Frame Connector with Pull Up Station 1PC
	4 Lower Frame Connector 1PC		6 Rotary Frame 2PCS		7 Roller Hanger 2PCS
	8 Left Adjusting Pipe 1PC		9 Right Adjusting Pipe 1PC		10 Upright Frame-20x1726mm 4PCS
	11 Guide Rod Fixing Plate 2PCS		12 Middle Frame Connector 1PC		13 Mounting Pole 4PCS
	14 Ringer 4PCS		15 Shield 2PCS		16 4.8 Cable Set 2PCS 298-3/7"(7580MM)
	17 Short Bar 1PC		18 Ankle Strap 1PC		19 Tricep Rope 1PC
	21 10LB Weight Stack 32PCS		22 10LB Counter Weight Stack Set 2PCS		23 17 Holes Shaft 2PCS

















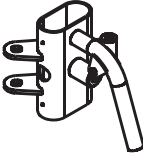
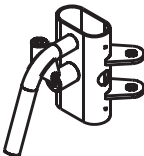

EXPLODED DRAWING & PARTS LIST

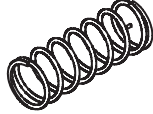
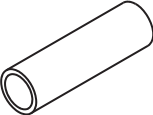
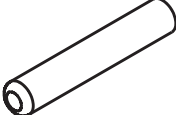
 24 Select Pin 2PCS	 25 Spring Pin-10x45mm 2PCS	 26 Hoist Hook-7x66mm 5PCS
 27 Rolling Bearing-32x12x10mm 4PCS	 31 Pulley-114x25.8mm 2PCS	 32 Pulley-89x25.8mm 14PCS
 33 Hollow Pipe Sleeve 4PCS	 34 Rod End Cover 8PCS	 35 Handle Grip-31.5x24x490mm 2PCS
 36 Elliptical Tube Stopper -PT50x100x2mm 4PCS	 37 Rubber Foot-175x125x11mm 4PCS	 38 Rubber Bumper-62x20x26mm 4PCS
 39 Rubber Bumper-38x33x15mm 2PCS	 40 Plug-12.5x11.2x20mm 2PCS	 41 Blind Nuts-M8 4PCS
 42 Socket Cap Screw-M10x65mm 2PCS	 43 Socket Cap Screw -M10x55mm 2PCS	 44 Hex Nut-M12 2PCS
 45 Umbrella Head Hexagon Socket Screw-M10x45mm 4PCS	 46 Socket Cap Screw -M10x25mm 22PCS	 47 Umbrella Head Hexagon Socket Screw-M8x25mm 4PCS





EXPLODED DRAWING & PARTS LIST

 48 Socket Cap Screw-M12x90mm 2PCS	 49 Umbrella Head Hexagon Socket Screw-M10x50mm 14PCS	 50 Umbrella Head Hexagon Socket Screw-M8x20mm 2PCS
 52 Cross Recessed Pan Head Tapping Screw-ST4.2x16mm 40PCS	 53 Flat Washer -24x13x2.5mm 4PCS	 54 Flat Washer -20x10.5x2mm 66PCS
 55 Big Washer-24x8.4x2mm 4PCS	 56 Big Washer-15x5.3x1.2mm 40PCS	 57 Spring Washer-M10 22PCS
 58 Spring Washer-M8 8PCS	 59 Nylon Insert Lock Nut-M10 22PCS	 60 Nylon Insert Lock Nut-M12 2PCS
 65 L Shape Plate 20PCS	 66 Front Shield 2PCS	 69 Single Grip Attachment 2PCS
 71 Rings Components 2PCS	 72 Hook Cover 2PCS	 73 Aluminum End Cover -38x6.5x13mm 2PCS
 74 Aluminum Ring -32x23x14.5mm 2PCS	 75 Aluminum Baffle Ring -35x26x13mm 2PCS	 76 Plastic Ring-30x26x4.5mm 2PCS

EXPLODED DRAWING & PARTS LIST

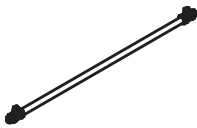
 <p>77 Socket Cap Screw-M6x25mm 2PCS</p>	 <p>78 Spring Washer-M6 2PCS</p>	 <p>79 Inner Hexagon End Set Screw-M5x5mm 4PCS</p>
 <p>80 Reinforcing Regula -16x9x1560mm 4PCS</p>	 <p>81 Countersunk Head Pull mandrel Rivet-5x12mm 4PCS</p>	 <p>82 Protect Plate 2PCS</p>
 <p>83 Right Sliding Frame 1PC</p>	 <p>84 Left Sliding Frame 1PC</p>	 <p>85 Select Adjusting Frame 2PCS</p>
 <p>86 Adjusting Bar 2PCS</p>	 <p>87 Aluminum End Cover -32x6.5x12mm 2PCS</p>	 <p>89 Spring-1.4x12.5x38mm 2PCS</p>
 <p>90 Handle Grip Cover -31.5x24x490mm 2PCS</p>	 <p>91 Handle Grip Cover -18x12x100mm 2PCS</p>	 <p>92 Roller Link 08A 2PCS</p>
 <p>93 Hexagon Screw-M6x20mm 2PCS</p>	 <p>94 Reed Nut-M6x20.8x10mm 2PCS</p>	 <p>95 Elliptical Pipe Plug -PT50x100x3mm 2PCS</p>
 <p>96 Cross Recess Pan Head Screw-M4x10mm 8PCS</p>	 <p>97 Spring Washer M4 8PCS</p>	 <p>98 Plain Washer -9x4.3x0.8mm 8PCS</p>

EXPLODED DRAWING & PARTS LIST

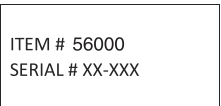
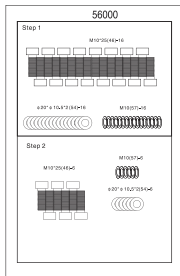
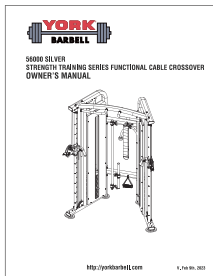
 <p>99 Long Bar 1PCS</p>	 <p>100 York Nameplate 1PC</p>	 <p>101 Warning Label 1PC</p>
 <p>102 Warranty Card 1PC</p>	 <p>103 Serial # Sticker 1PC</p>	 <p>104 Hardware Card 1PC</p>
 <p>105 Assembly Instruction 1PC</p>		



ASSEMBLY INSTRUCTION

STEP 1

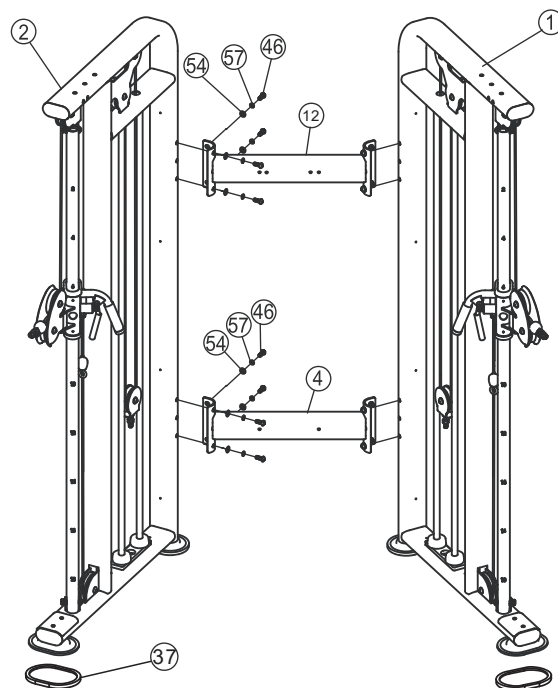
- 4 Lower Frame Connector x 1PC
- 12 Middle Frame Connector x 1PC
- 37 Rubber Foot-175x125x11mm x 4PCS
- 46 Socket Cap Screw-M10x25mm x 16PCS 
- 54 Flat Washer-20x10.5x2mm x 16PCS 
- 57 Spring Washer-M10 x 16PCS 
- 1 (1+6+8+15+31+32+84)Pre-Assembly x 1PC
- 2 (1+6+9+15+31+32+83)Pre-Assembly x 1PC



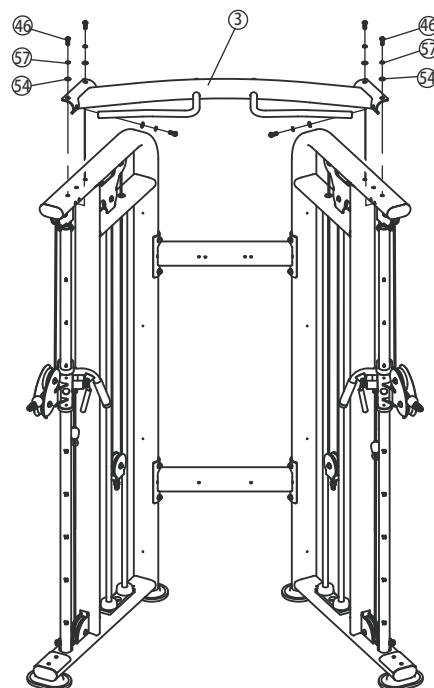

STEP 2

- 46 Socket Cap Screw-M10x25mm x 6PCS 
- 54 Flat Washer-20x10.5x2mm x 6PCS 
- 57 Spring Washer-M10 x 6PCS 
- 2 (3+35+73+74+75+76)Pre-Assembly x 1PC





ASSEMBLY INSTRUCTION

STEP 3

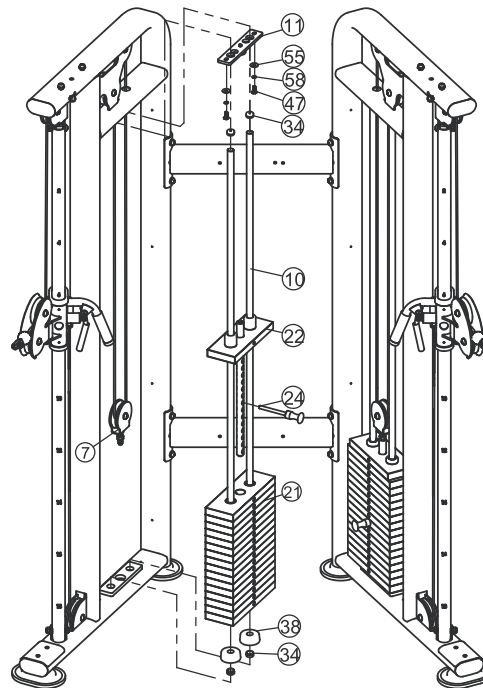
- 7 Roller Hanger x 2PCS
- 10 Guide Rod-20x1726mm x 4PCS
- 11 Guide Rod Fixing Plate x 2PCS
- 24 Select Pin x 2PCS
- 34 Rod End Cover x 8PCS
- 38 Rubber Bumper-62x20x26mm x 4PCS
- 47 Umbrella Head Hexagon Socket Screw -M8x25mm (Pre-Assembly) x 4PCS 
- 55 Big Washer-24x8.4x2mm (Pre-Assembly) x 4PCS 
- 58 Spring Washer-M8 (Pre-Assembly) x 4PCS 
- 22 (22+23+25)Pre-Assembly x 2PCS



STEP 4

- 52 Cross Recessed Pan Head Tapping Screw-ST4.2x16mm (Pre-Assembly) x 20PCS 
- 56 Big Washer-15x5.3x1.2mm (Pre-Assembly) x 20PCS 
- 66 (66+80)Pre-Assembly x 2PCS

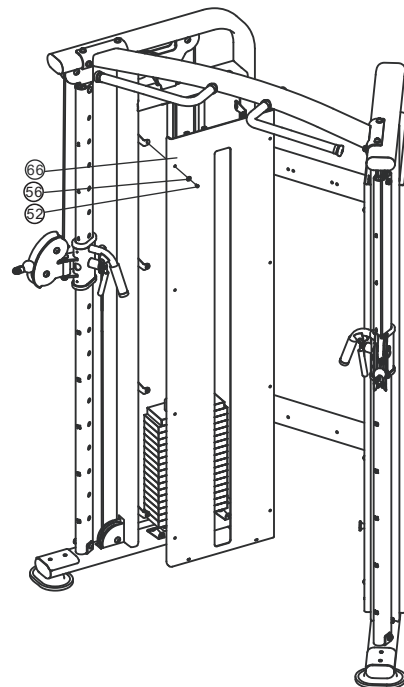

ASSEMBLY INSTRUCTION

STEP 5

69 Single Grip Attachment x 2PCS

12 (12+26)Pre-Assembly x1PC

17 (17+26)Pre-Assembly x1PC

18 (18+26)Pre-Assembly x1PC

19 (19+26)Pre-Assembly x1PC

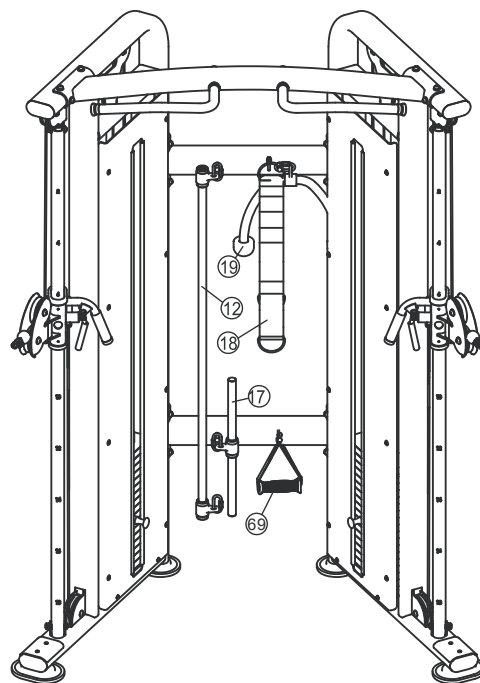

Please visit us at our website
for more products and information.

