

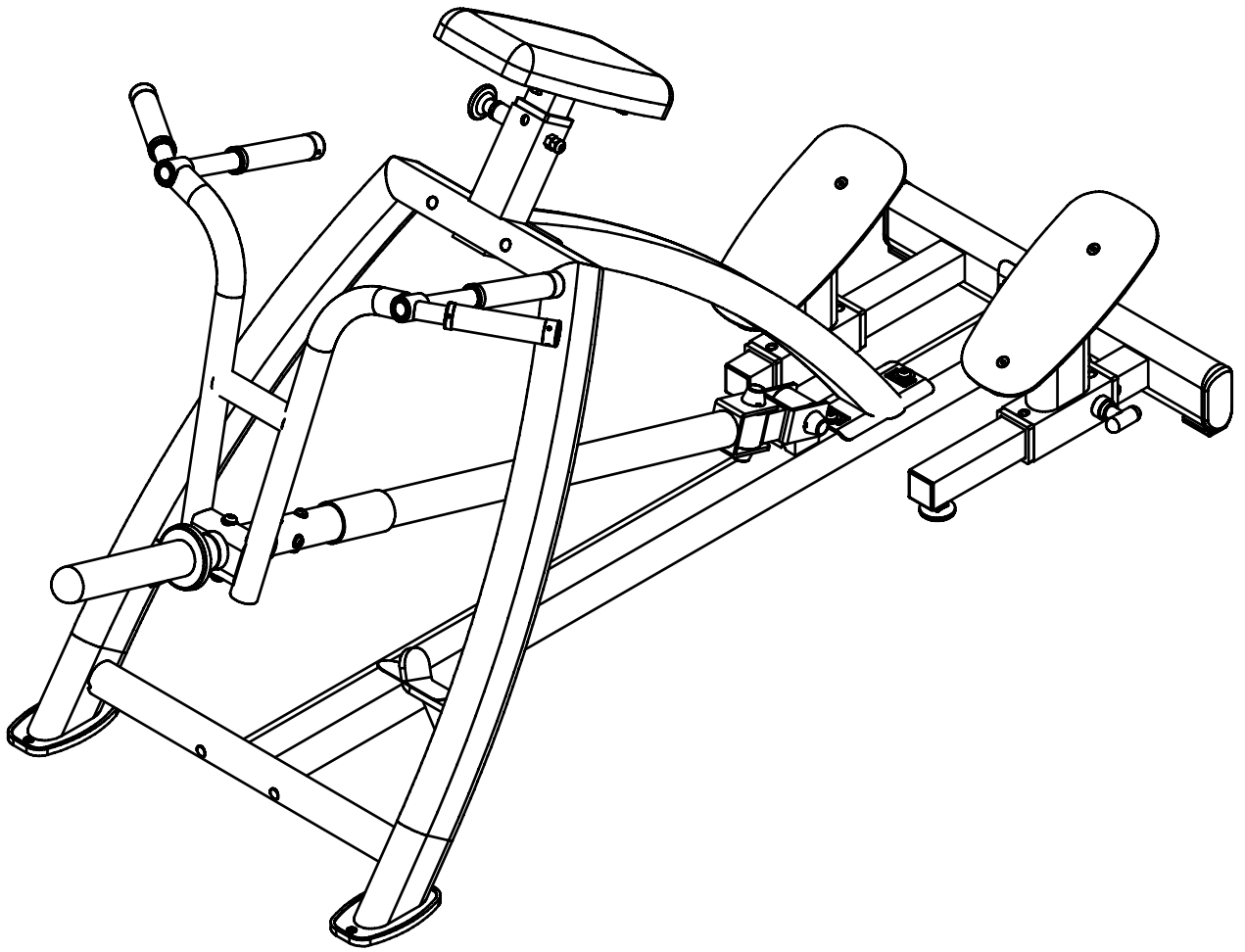

PLTR



Assembly & Instructions
OWNER'S & MANUAL

HARDWARE

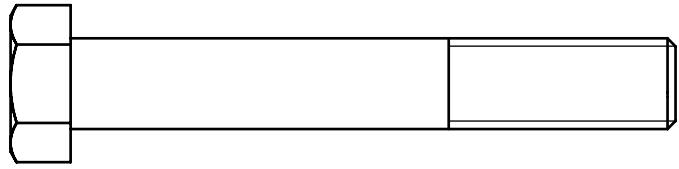
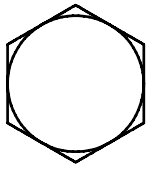

A1. M12X80 HEX HEAD SCREW...2PCS

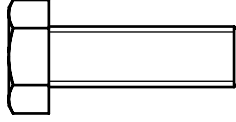
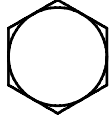

A2. M8X25 HEX HEAD SCREW...4PCS

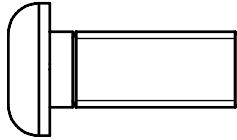
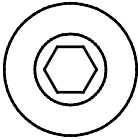

A3. M10X25 ALLEN SCREW(FULL THREAD)(Pre-installed...1PCS)...9PCS

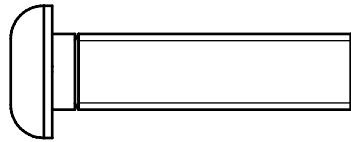
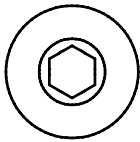

A4. M10X40 ALLEN SCREW(FULL THREAD)...2PCS

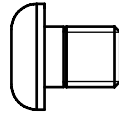
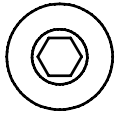

A5. M8X10 ALLEN SCREW(FULL THREAD)...6PCS

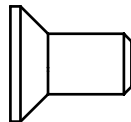
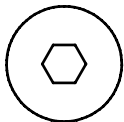

A6. M8X16 TAPER SCREW(FULL THREAD)...4PCS



A10. M5X5 GRUB SCREW...16PCS(Pre-installed)

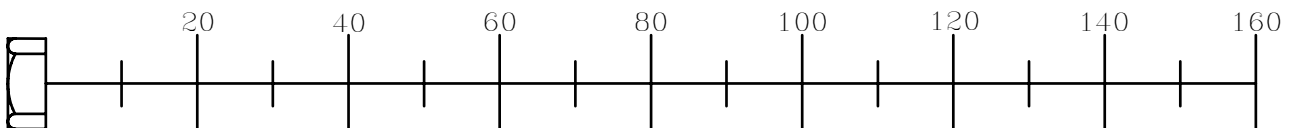

HARDWARE

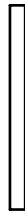
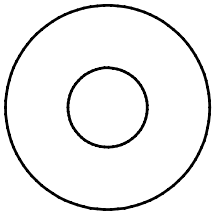

C1. M10 WASHER...4PCS

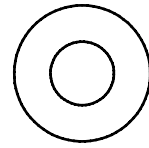

C2. M8 WASHER...4PCS

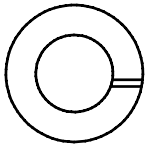

C3. M10 SPRING WASHER...2PCS

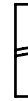
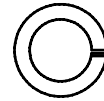

C4. M8 SPRING WASHER...4PCS

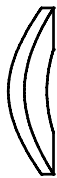
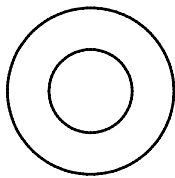

C5. M10 CURVED WASHER...6PCS

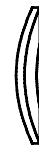
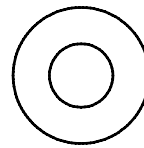

C6. M8 CURVED WASHER...6PCS

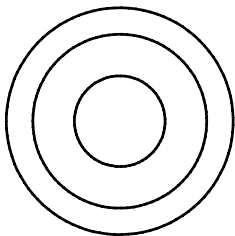

C7. M12 PLATE WASHER...4PCS

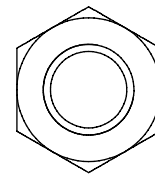

B3. M12 LOCK NUT...2PCS

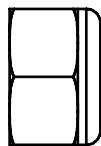
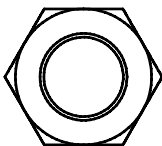

B1. M12 NYLON LOCK NUT...2PCS

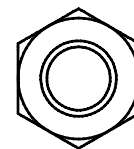

B2. M10 LOCK NUT...1PCS(Pre-installed)

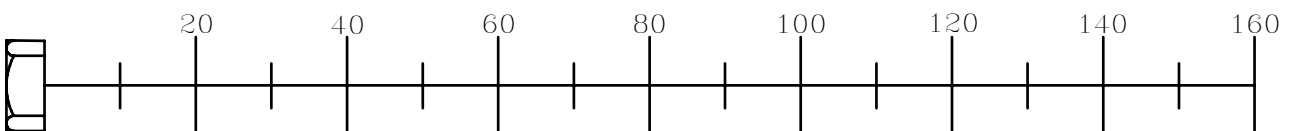

PLTR PARTS

A [1PCS]

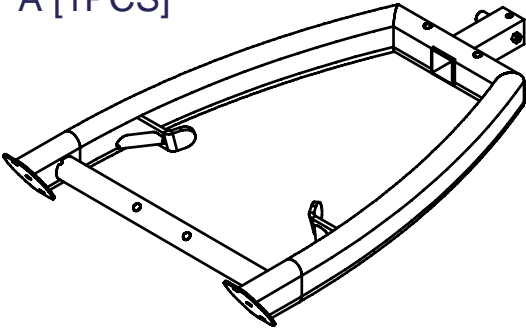

B [1PCS]

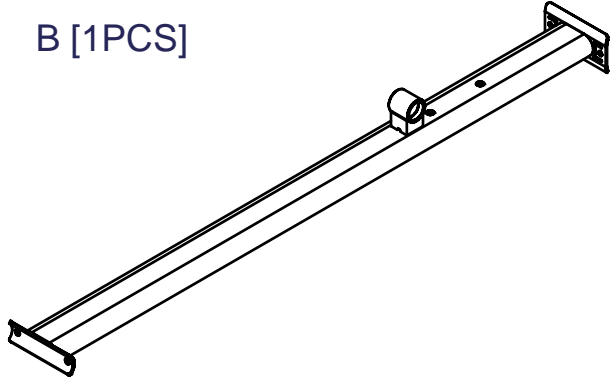

C [1PCS]

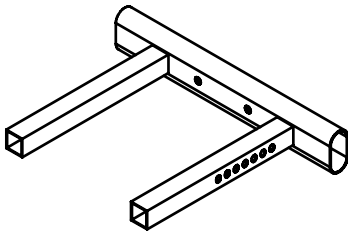

D [1PCS]

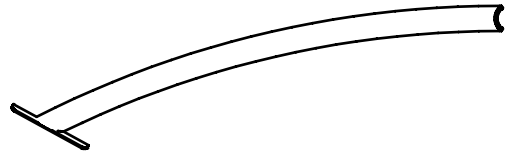

E [1PCS]

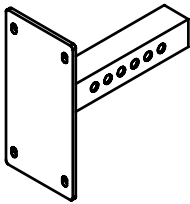

F [1PCS]

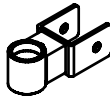

L [1PCS]

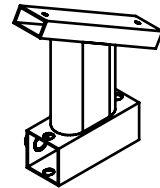

G [1PCS]

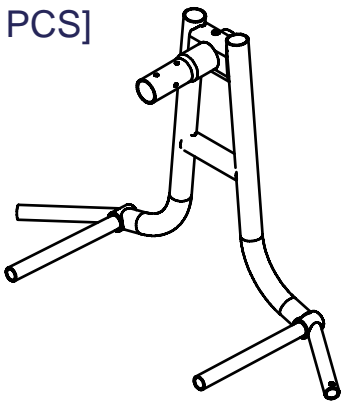

M [1PCS]

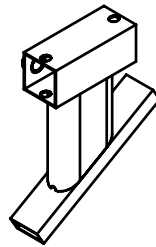

N [1PCS]

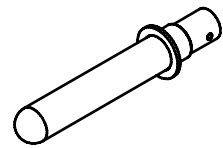

Q [1PCS]
9111086

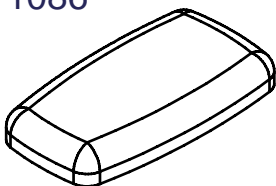

R [2PCS]
8370051

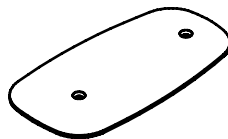

P [1PCS]

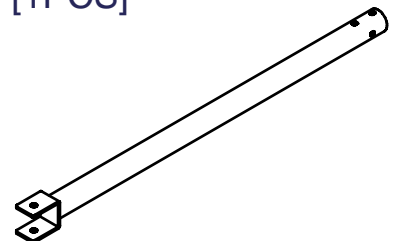

PLTR PARTS

D1. Chrome collar (8130-254) (Pre-installed)-----	[4PCS]
D2. Flat head pop pin (8250-012) (Pre-installed)-----	[2PCS]
D3. Flat head pop pin (8250-065G) (Pre-installed)-----	[1PCS]
D4. Bearing (8510-003) (Pre-installed)-----	[4PCS]
D5. Chrome collar (8890-061) (Pre-installed)-----	[4PCS]
D6. Foam grip (9162-147) (Pre-installed)-----	[2PCS]
D8. Foam grip (9162-133) (Pre-installed)-----	[2PCS]
D9. End cap (9211-004)-----	[3PCS]
D10. Nylon bushing (9211-032)-----	[4PCS]
D11. Nylon bushing (9211-047)-----	[1PCS]
D12. End cap (9211-086)-----	[4PCS]
D13. End cap (9211-117)-----	[2PCS]
D14. Rubber dount (9214-045)-----	[2PCS]
D15. Rubber stop (9310-016)-----	[1PCS]
D16. Rubber insert (9310-076)-----	[2PCS]
D17. Cap sheath (9212-026)-----	[4PCS]
D18. Copper sheath (8520-032) (Pre-installed)-----	[4PCS]
D19. Foam grip (9162-134) (Pre-installed)-----	[1PCS]
D20. Antiskid sandcloth (9630-218)-----	[2PCS]

D1



D2

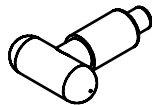

D3



D4



D5



D6

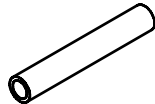

D8

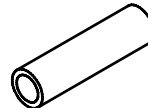

D9



D10

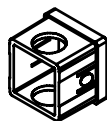

D11

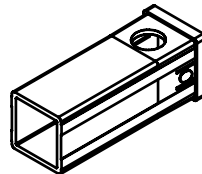

D12



D13

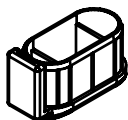

D14



D15



D16

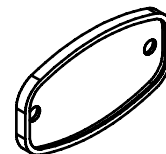

D17



D18



D19

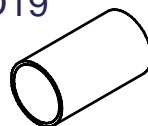

D20



PLTR

