

FLUKE®

362

Clamp Meter

Users Manual

PN 3622678

August 2010, Rev. 1, 4/13

© 2010, 2013 Fluke Corporation. All rights reserved. Printed in China. Specifications are subject to change without notice. All product names are trademarks of their respective companies.

LIMITED WARRANTY AND LIMITATION OF LIABILITY

This Fluke product will be free from defects in material and workmanship for two years from the date of purchase. This warranty does not cover fuses, disposable batteries, or damage from accident, neglect, misuse, alteration, contamination, or abnormal conditions of operation or handling. Resellers are not authorized to extend any other warranty on Fluke's behalf. To obtain service during the warranty period, contact your nearest Fluke authorized service center to obtain return authorization information, then send the product to that Service Center with a description of the problem.

THIS WARRANTY IS YOUR ONLY REMEDY. NO OTHER WARRANTIES, SUCH AS FITNESS FOR A PARTICULAR PURPOSE, ARE EXPRESSED OR IMPLIED. FLUKE IS NOT LIABLE FOR ANY SPECIAL, INDIRECT, INCIDENTAL OR CONSEQUENTIAL DAMAGES OR LOSSES, ARISING FROM ANY CAUSE OR THEORY. Since some states or countries do not allow the exclusion or limitation of an implied warranty or of incidental or consequential damages, this limitation of liability may not apply to you.

Table of Contents

Title	Page
Introduction.....	1
Contact Fluke	2
Safety Information	3
The Meter	11
Specifications	17
Electrical Specifications.....	17
Mechanical Specifications	18
Environmental Specifications	19
Safety Specifications	20

Introduction

Warning

Read "Safety Information" before you use the Meter.

The Fluke 362 is a hand-held, battery-operated clamp meter (the Meter) that measures:

- ac and dc current and voltage
- resistance
- continuity

The Meter ships with:

- TL75 test leads
- two AAA batteries (installed)
- *362 User Manual*

Contact Fluke

To contact Fluke, call one of the following telephone numbers:

- Technical Support USA: 1-800-44-FLUKE (1-800-443-5853)
- Calibration/Repair USA: 1-888-99-FLUKE (1-888-993-5853)
- Canada: 1-800-36-FLUKE (1-800-363-5853)
- Europe: +31 402-675-200
- Japan: +81-3-3434-0181
- Singapore: +65-738-5655
- China: +86-400-810-3435
- Anywhere in the world: +1-425-446-5500

Or, visit Fluke's website at www.fluke.com.

To register your product, visit <http://register.fluke.com>.

To see, print, or download the latest manual supplement, visit <http://us.fluke.com/usen/support/manuals>.

Safety Information

A **Warning** identifies conditions and actions that pose hazard(s) to the user. A **Caution** identifies conditions and procedures that could cause Meter damage, equipment under test damage, or permanent loss of data.

Symbols used on the Meter and in this manual are explained in Table 1.

Warning

To prevent possible electrical shock or personal injury, follow these guidelines:

- **Use the Meter only as specified in this manual or the protection provided by the Meter can be compromised.**
- **Examine the case before you use the Meter. Look for cracks or missing plastic. Carefully look at the insulation around the connectors.**
- **Never measure current while the test leads are inserted into the input jacks.**
- **Make sure the battery door is closed and latched before operating the Meter.**

- **Remove the test leads from the Meter before the battery door is opened.**
- **Examine the test leads for damaged insulation or exposed metal. Check test lead continuity. Replace damaged test leads before using the Meter.**
- **Do not use the Meter if it operates incorrectly. Protection can be compromised. When in doubt, have the Meter serviced.**
- **Do not use the Meter around explosive gas, vapor or in damp or wet environments.**
- **Use only type AAA batteries, properly installed in the Meter case, to power the Meter.**
- **When batteries are changed, make sure the calibration seal in the battery compartment is not damaged. If damaged, the Meter may not be safe to use. Return the Meter to Fluke for replacement of the seal.**
- **When measuring, keep fingers behind the Tactile Barrier. See "The Meter" ①.**

- To avoid false readings that can lead to electrical shock and injury, replace the batteries as soon as the low battery indicator () appears.
- When servicing the Meter, use only specified replacement parts.
- Have the Meter serviced only by qualified service personnel.
- Be careful around voltages > 30 V ac rms, 42 V ac peak, or 60 V dc. Such voltages pose a shock hazard.
- Do not apply more than the rated voltage, as marked on the Meter, between the terminals or between any terminal and earth ground.
- When using the probes, keep fingers behind the finger guards on the probes.
- Connect the common test lead before connecting the live test lead. When disconnecting test leads, disconnect the live test lead first.
- Do not work alone so assistance can be rendered in an emergency.

- **Use extreme caution when working around bare conductors or bus bars. Contact with the conductor could result in electric shock.**
- **Adhere to local and national safety codes. Individual protective equipment must be used to prevent shock and arc blast injury where hazardous live conductors are exposed.**
- **Disconnect circuit power and discharge all high-voltage capacitors before you do diode tests or measure resistance or continuity.**
- **Do not measure ac/dc current in circuits carrying more than 600 V or 200 A with the Meter Jaw.**
- **Never operate the Meter with the back cover removed or the case open.**
- **Remove the batteries if the Product is not used for an extended period of time, or if stored in temperatures above 50 °C. If the batteries are not removed, battery leakage can damage the Product.**

- **Measure a known voltage first to make sure that the Product operates correctly.**
- **Only use probes, test leads, and accessories that have the same measurement category, voltage, and amperage ratings as the Product.**
- **Use Product-approved measurement category (CAT), voltage, and amperage rated accessories (probes, test leads, and adapters) for all measurements.**
- **Do not exceed the Measurement Category (CAT) rating of the lowest rated individual component of a Product, probe, or accessory.**

⚠ Caution

To avoid possible damage to the Meter or to equipment under test:

- **Use the proper jacks, function, and range for the measurement application.**
- **Clean the case and accessories with a damp cloth and mild detergent only. Do not use abrasives or solvents.**

Table 1. Symbols











Symbol	Meaning	Symbol	Meaning
	AC (Alternating Current)		Earth ground
	DC (Direct Current)		Double insulated
	Hazardous voltage		Conforms to European Union directives.
	Risk of Danger. Important information. See Manual.		Conforms to relevant North American Safety Standards.
	Battery. Low battery when shown on display.		Application around and removal from HAZARDOUS LIVE conductors is permitted.

Table 1. Symbols (cont.)

Symbol	Meaning	Symbol	Meaning
CAT II	Measurement Category II is applicable to test and measuring circuits connected directly to utilization points (socket outlets and similar points) of the low-voltage MAINS installation.	CAT III	IEC Measurement Category III CAT III equipment has protection against transients in equipment in fixed-equipment installations, such as distribution panels, feeders and short branch circuits, and lighting systems in large buildings.

Table 1. Symbols (cont.)

Symbol	Meaning	Symbol	Meaning
CAT IV	Measurement Category IV is applicable to test and measuring circuits connected at the source of the building's low-voltage MAINS installation.		This product complies with the WEEE Directive (2002/96/EC) marking requirements. The affixed label indicates that you must not discard this electrical/electronic product in domestic household waste. Product Category: With reference to the equipment types in the WEEE Directive Annex I, this product is classed as category 9 "Monitoring and Control Instrumentation" product. Do not dispose of this product as unsorted municipal waste. Go to Fluke's website for recycling information.

The Meter

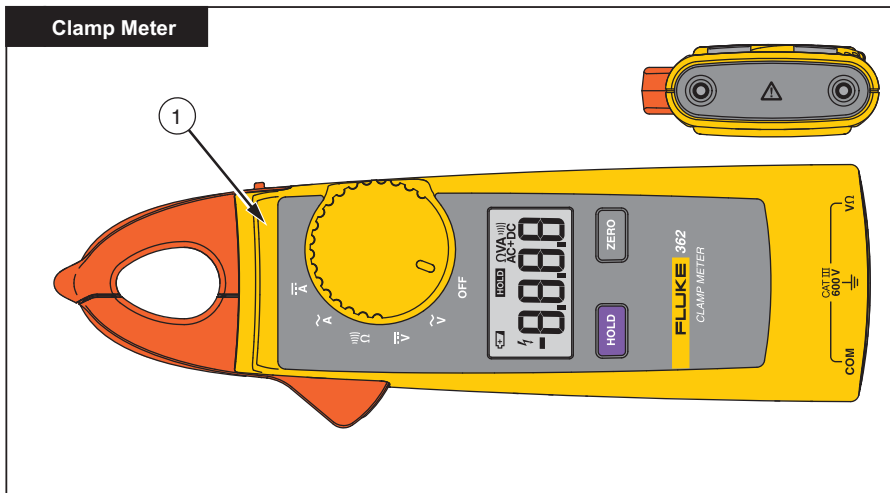
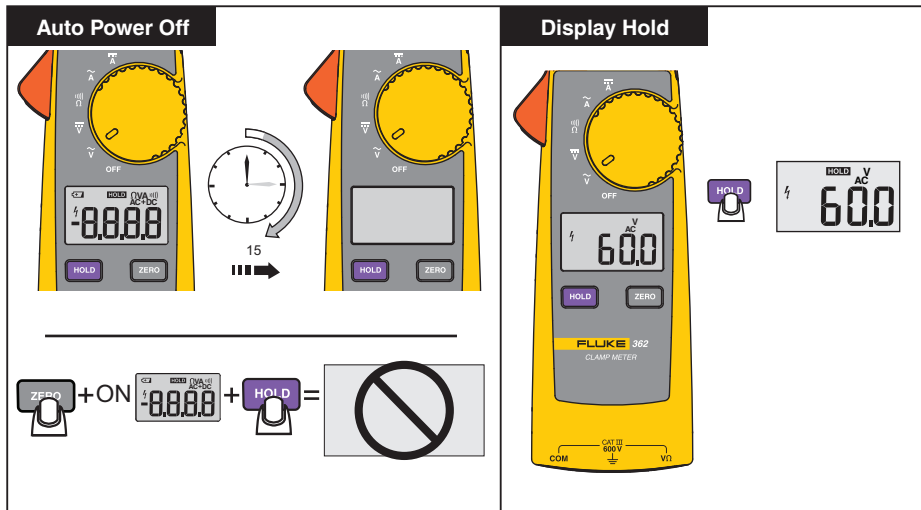

fig01.eps



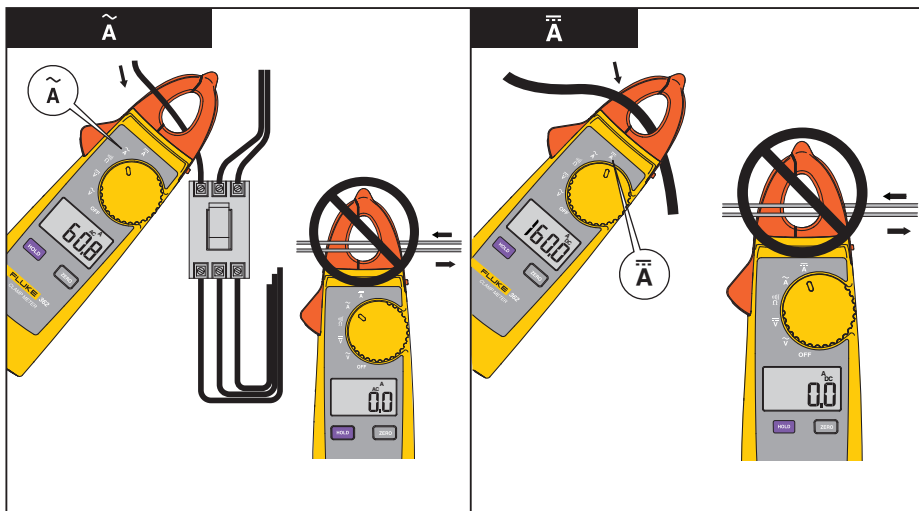

Fig04_05.eps

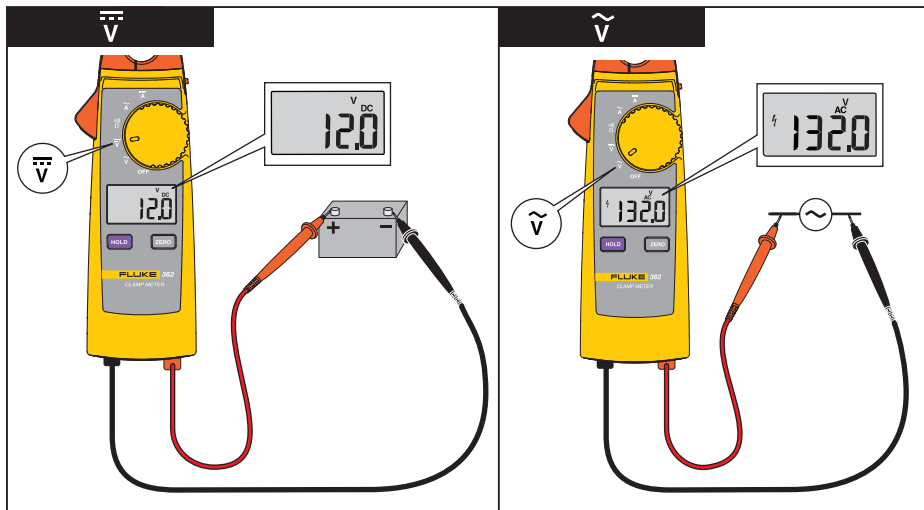

fig06_07.eps

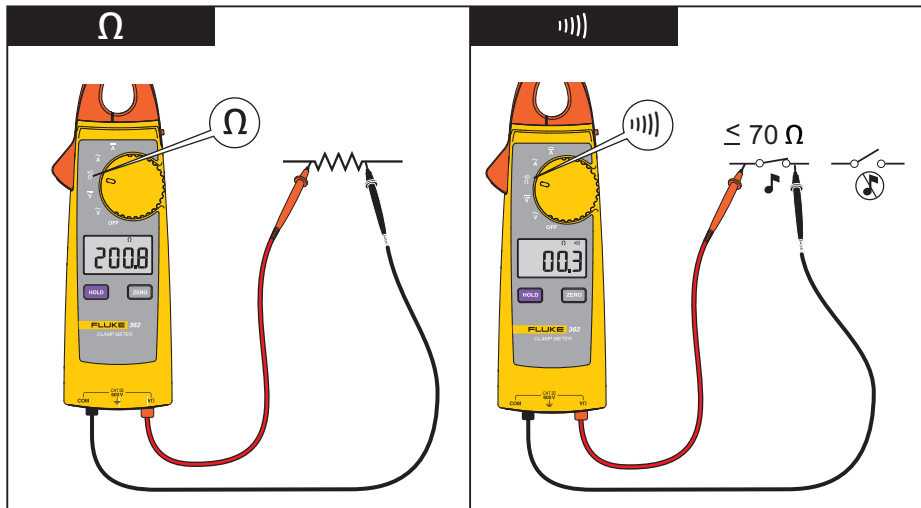

Fig08_09.eps

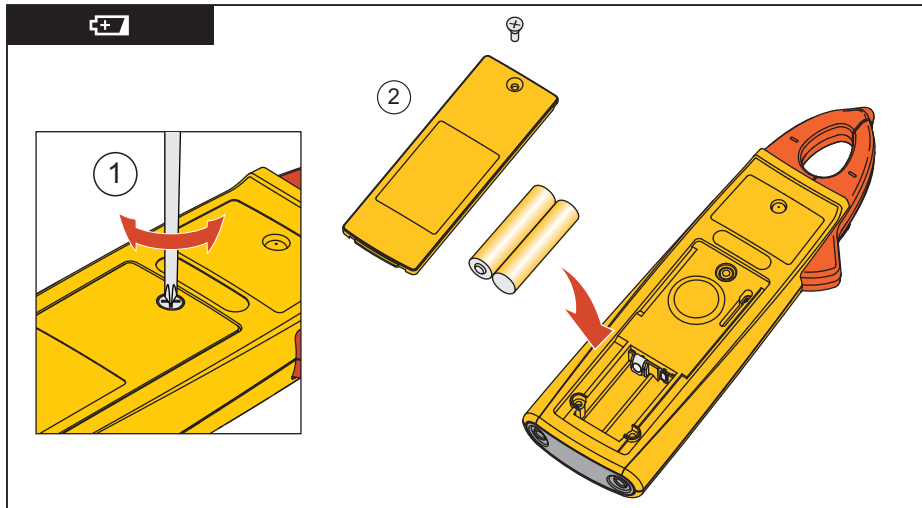

Fig10.eps

Specifications

Electrical Specifications

AC Current

Range	200.0 A
Resolution	0.1 A
Accuracy	2 % \pm 5 digit (45 Hz-65 Hz)
	2.5 % \pm 5 digits (65 Hz-400 Hz)

DC Current

Range	200.0 A
Resolution	0.1 A
Accuracy	2 % \pm 5 digit

AC Voltage

Range	600.0 V
Resolution	0.1 V
Accuracy	1.5 % \pm 5 digits (45 Hz-400 Hz)

DC Voltage

Range	600.0 V
Resolution	0.1 V
Accuracy	1 % \pm 5 digits

Resistance

Range	300 Ω / 3000 Ω
Resolution	0.1 Ω /1 Ω
Accuracy	1 % \pm 5 digits

Continuity

Beeper on Threshold	\leq 70 Ω
---------------------------	--------------------

Mechanical Specifications

Size (L x W x H)	205 mm x 60 mm x 22 mm
Weight.....	196 g
Jaw Opening.....	18 mm

Environmental Specifications

Operating Temperature.....	0 °C to +40 °C
Storage Temperature.....	-30 °C to +60 °C, 100 hours under -40 °C
Operating Humidity	Non condensing (< 10 °C)
	≤ 90 % RH (at 10 °C to 30 °C)
	≤ 75 % RH (at 30 °C to 40 °C)
	≤ 45 % RH (at 40 °C to 50 °C)
	(Without Condensation)
Operating Altitude	2000 meters
Storage Altitude	12,000 meters
IP Rating	IP 30 per IEC/EN 60529; Case
Vibration Requirements	MIL-PRF-28800F, Class 2

Electromagnetic Environment.....	IEC/EN 61326-1 (portable)
Temperature Coefficients.....	Add 0.1 x specified accuracy for each degree C above 28 °C or below 18 °C

Safety Specifications

Safety Compliance.....	IEC/EN 61010-1 IEC/EN 61010-2-032
Batteries.....	2 AAA