

# Mirror Assembling Instruction

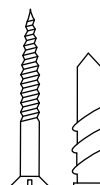

4 x metal plates are attached to mirror



2 x screws and white nylon screw type plug

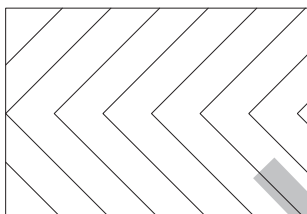
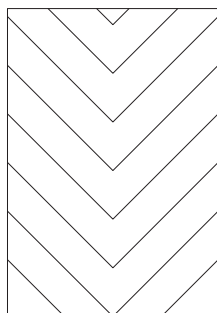
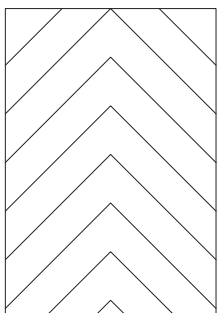

## Step1

Make sure what direction you would like to hang the mirror?

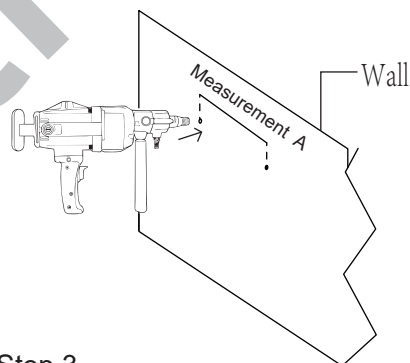
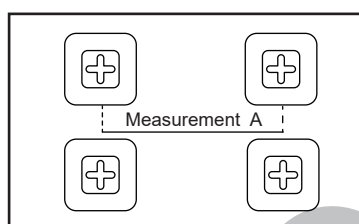

## Step2

Measure the distance of A

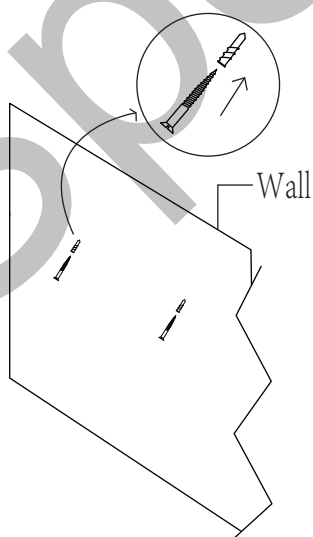

## Step 3

Marked 2 dots on wall with length of A, and drill holes

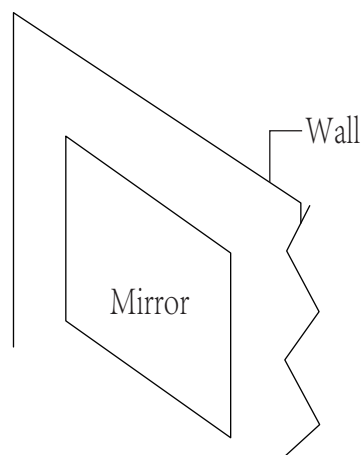

## Step 4

Put the white nylon screw type plug in the holes and screws in to the plug

## Step 5

Hang the mirror to wall

## MIRROR CARE

1. Please ensure not to scratch the back of the mirror when you apply the mirror onto the wall
2. Clean your mirrors using methylated spirits and water at a ratio of 30% methylated spirits and 70% water.
3. Please avoid getting water on the back and sides of the mirror as damage to silver backing can occur.