

Mirror Assembling Instruction

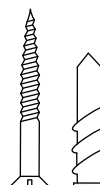

3 x metal plates are attached to mirror



2 x screws and white nylon screw type plug

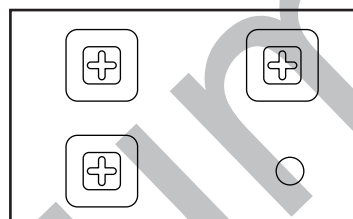
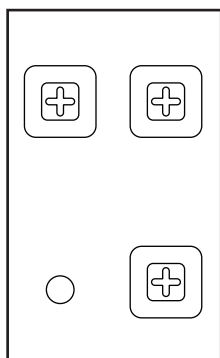

Step1

Make sure what direction you would like to hang the mirror? Horizontal or Vertical?

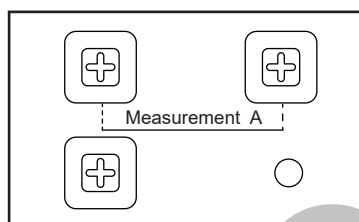

Step2

Measure the distance of A

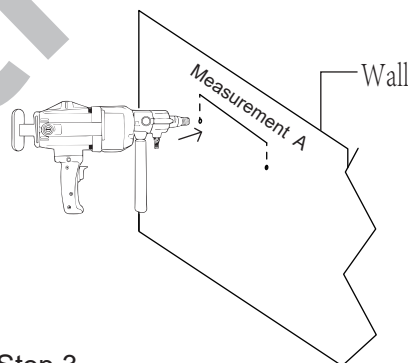

Step 3

Marked 2 dots on wall with length of A, and drill holes

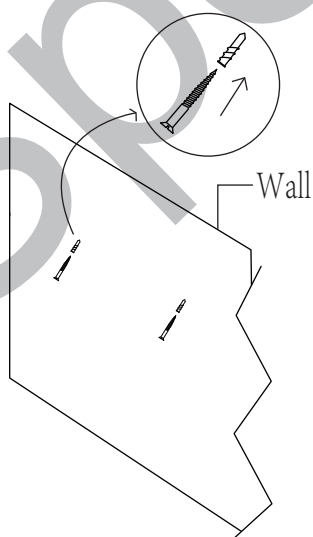

Step 4

Put the white nylon screw type plug in the holes and screws in to the plug

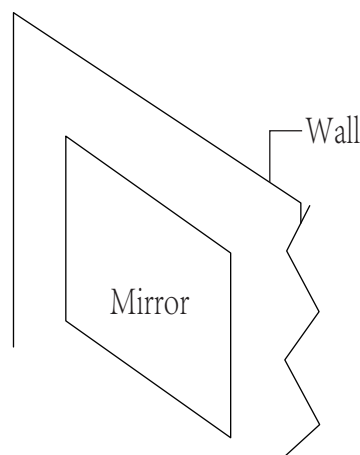

Step 5

Hang the mirror to wall

MIRROR CARE

1. Please ensure not to scratch the back of the mirror when you apply the mirror onto the wall
2. Clean your mirrors using methylated spirits and water at a ratio of 30% methylated spirits and 70% water.
3. Please avoid getting water on the back and sides of the mirror as damage to silver backing can occur.