



Nothing but **HEAVY DUTY.**

HAND TOOLS AND STORAGE FALL 2019



**ULTIMATE PRODUCTIVITY.
SUPERIOR PERFORMANCE.**

STUD™ TAPE MEASURES

INDUSTRY'S MOST DURABLE TAPE MEASURE

14' STANDOUT



SURVIVES 80' DROP**

Fully Reinforced, Impact Resistant Frame

Longest Lasting Blade



Finger Stop
Protects from blade retraction

2-Sided Printing
Increased measurement readability

Anti-Tear Coating
Reinforces first 6" of blade



Rip & Wear Resistant Blade

Model #	Description
48-22-9716	16ft STUD™ Tape Measure
48-22-9725	25ft STUD™ Tape Measure
48-22-9735	35ft STUD™ Tape Measure

Model #	Description
48-22-9717	5m/16ft STUD™ Tape Measure
48-22-9726	8m/26ft STUD™ Tape Measure
48-22-9725M	25ft STUD™ Magnetic Tape Measure

WIDE BLADE TAPE MEASURES

LONGEST STRAIGHTEST STANDOUT*

14' STANDOUT

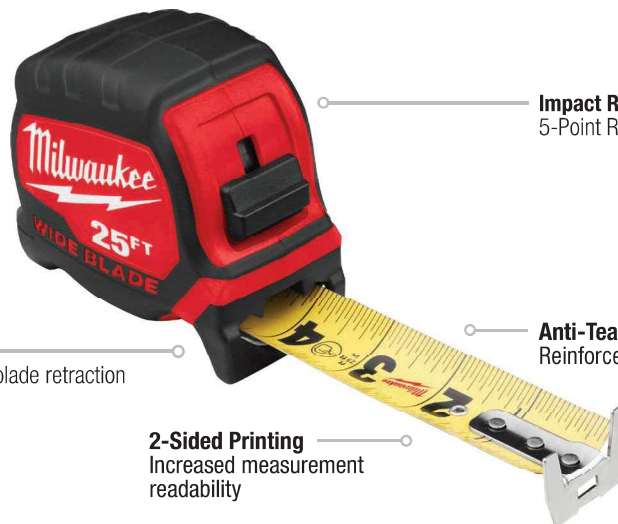

Impact Resistant Frame
5-Point Reinforced

Anti-Tear Coating
Reinforces first 6" of blade

Finger Stop
Protects from blade retraction

2-Sided Printing
Increased measurement readability



Long reach for efficient measuring

Model #	Description
48-22-0216	16ft Wide Blade Tape Measure
48-22-0225	25ft Wide Blade Tape Measure
48-22-0230	30ft Wide Blade Tape Measure
48-22-0235	35ft Wide Blade Tape Measure
48-22-0240	40ft Wide Blade Tape Measure

Model #	Description
48-22-0217	5m/16ft Wide Blade Tape Measure
48-22-0226	8m/26ft Wide Blade Tape Measure
48-22-0216M	16ft Wide Blade Magnetic Tape Measure
48-22-0225M	25ft Wide Blade Magnetic Tape Measure

*Based on maximum performance
**Functional After 80' Drop on Packed Soil

COMPACT WIDE BLADE TAPE MEASURES

12' STANDOUT™

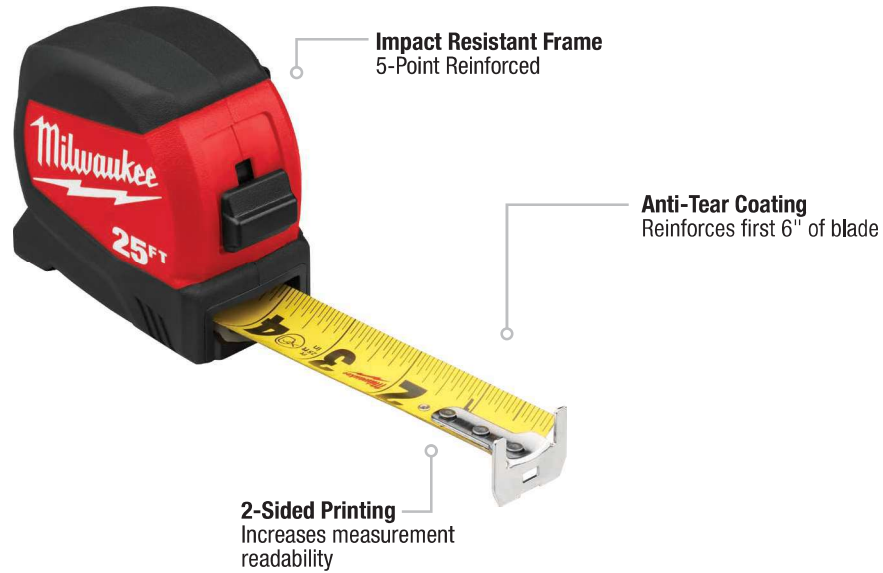

2-Sided Printing

Model #	Description
48-22-0416	16ft Compact Wide Blade Tape Measure
48-22-0425	25ft Compact Wide Blade Tape Measure
48-22-0430	30ft Compact Wide Blade Tape Measure
48-22-0417	5m/16ft Compact Wide Blade Tape Measure
48-22-0426	8m/26ft Compact Wide Blade Tape Measure

Model #	Description
48-22-0316	16ft Compact Wide Blade Magnetic Tape Measure
48-22-0325	25ft Compact Wide Blade Magnetic Tape Measure
48-22-0335	35ft Compact Wide Blade Magnetic Tape Measure
48-22-0317	5m/16ft Compact Wide Blade Magnetic Tape Measure
48-22-0326	8m/26ft Compact Wide Blade Magnetic Tape Measure

COMPACT TAPE MEASURES

9' STANDOUT™



Also Available:



25ft Compact Tape Measure with Engineer Scale
48-22-6625E



Nylon Blade Coating

Model #	Description
48-22-6612	12ft Compact Tape Measure
48-22-6616	16ft Compact Tape Measure
48-22-6625	25ft Compact Tape Measure
48-22-6630	30ft Compact Tape Measure
48-22-6613	3m/12ft Compact Tape Measure
48-22-6617	5m/16ft Compact Tape Measure
48-22-6626	8m/26ft Compact Tape Measure

Model #	Description
48-22-6816	16ft Compact Auto-Lock Tape Measure
48-22-6825	25ft Compact Auto-Lock Tape Measure
48-22-6817	5m/16ft Compact Auto-Lock Tape Measure
48-22-6826	8m/26ft Compact Auto-Lock Tape Measure
48-22-6625E	25ft Compact Tape Measure with Engineer Scale
48-22-5506	2m/6ft Keychain Tape Measure
48-22-6601	10ft/3m Keychain Tape Measure with LED

OPEN REEL LONG TAPES

50% LESS STRETCH

3:1 Metal Planetary Gears
Prevents gear stripping & stress



GRIME GUARD™ Blade Wiper
Smoothest retraction

Nylon Bond

Kink-Resistant Blade

2 Sided Printing

FIBERGLASS LONG TAPES

SMOOTHEST RETRACTION

3:1 Metal Planetary Gears
Prevents gear stripping & stress



GRIME GUARD™ Blade Wiper
Smoothest retraction

2 Sided Printing

Model #	Description
48-22-5201	100ft Open Reel Steel Long Tape
48-22-5230	300ft Open Reel Steel Long Tape

Model #	Description
48-22-5301	100ft Fiberglass Open Reel Long Tape
48-22-5302	200ft Fiberglass Open Reel Long Tape
48-22-5303	300ft Fiberglass Open Reel Long Tape
48-22-5310	100m/330ft Fiberglass Open Reel Long Tape
48-22-5330	30m/100ft Fiberglass Open Reel Long Tape
48-22-5360	60m/200ft Fiberglass Open Reel Long Tape

CLOSED REEL LONG TAPE

LONGEST LIFE

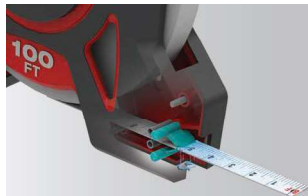

GRIME GUARD™
Industry's First Blade Wiper

3:1 Torque Dispersing Planetary Gears
Prevents gear stripping & stress

Reinforced Metal Frame



GRIME GUARD™ Blade Wiper
Smoothest retraction

Nylon Coated Blade

2 Sided Printing

Model #	Description
48-22-5101	100ft Closed Reel Long Tape

MEASURING WHEELS

MOST DURABLE. MOST ACCURATE.



Debris Cleaning Wheel Flap

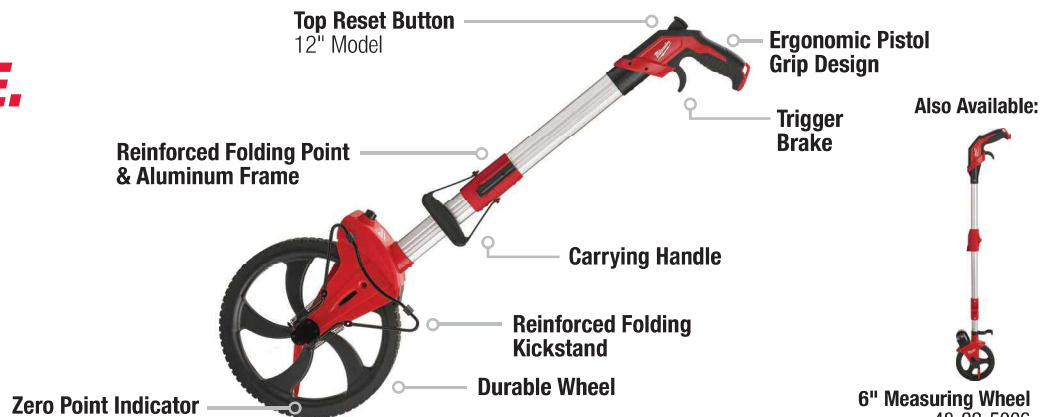

Model #	Description
48-22-5012	12" Measuring Wheel
48-22-5013	12" Engineer's Measuring Wheel

Model #	Description
48-22-5006	6" Measuring Wheel

REDSTICK™ DIGITAL LEVELS

**SUPERIOR ACCURACY.
DYNAMIC READOUT.**

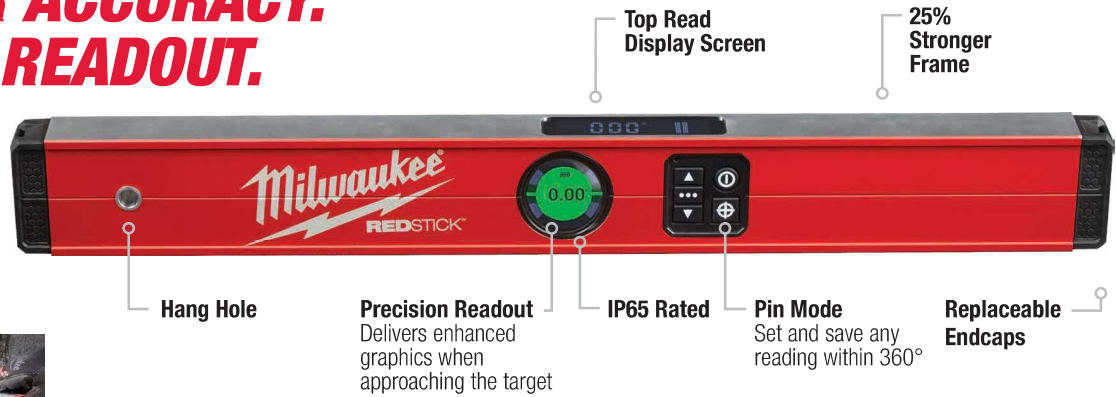

**PINPOINT MEASUREMENT™
Technology**

Model #	Description
MLDIG14	14" REDSTICK™ Digital Level with PINPOINT™ Measurement Technology
MLDIG24	24" REDSTICK™ Digital Level with PINPOINT™ Measurement Technology
MLDIG48	48" REDSTICK™ Digital Level with PINPOINT™ Measurement Technology
MLDIG72	72" REDSTICK™ Digital Level with PINPOINT™ Measurement Technology

REDSTICK™ BOX LEVELS

**MOST DURABLE.
GUARANTEED ACCURACY.**

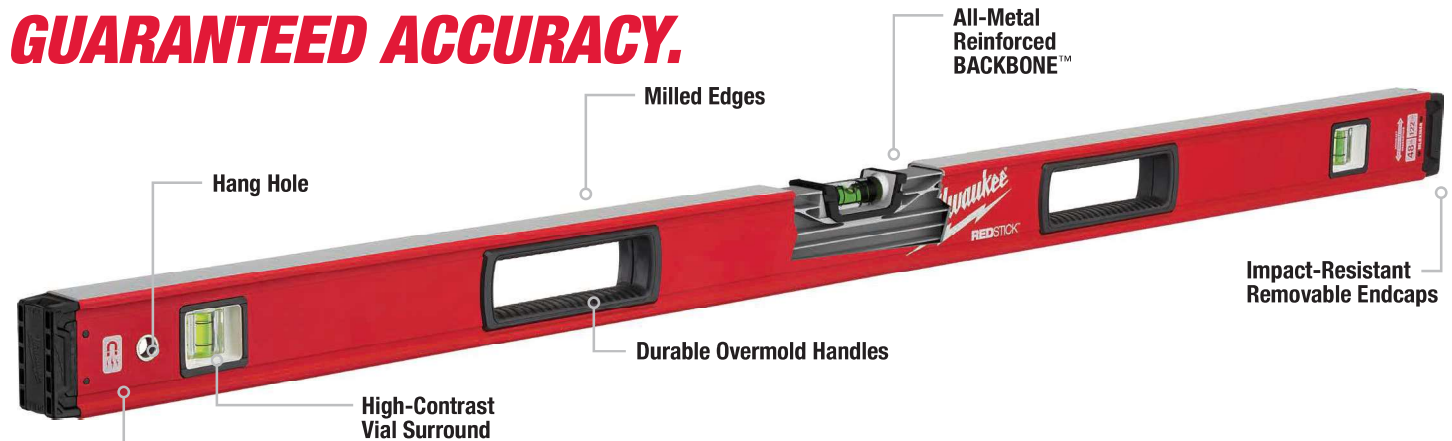

**Amplified
Rare-Earth
Magnets**

Model #	Description
MLBX16	16" REDSTICK™ Box Level
MLBXM16	16" REDSTICK™ Magnetic Box Level
MLBX24	24" REDSTICK™ Box Level
MLBXM24	24" REDSTICK™ Magnetic Box Level
MLBX32	32" REDSTICK™ Box Level
MLBXM32	32" REDSTICK™ Magnetic Box Level
MLBX36	36" REDSTICK™ Box Level
MLBXM36	36" REDSTICK™ Magnetic Box Level
MLBX48	48" REDSTICK™ Box Level
MLBXM48	48" REDSTICK™ Magnetic Box Level
MLBX59	59" REDSTICK™ Box Level
MLBXM59	59" REDSTICK™ Magnetic Box Level
MLBX72	72" REDSTICK™ Box Level
MLBXM72	72" REDSTICK™ Magnetic Box Level

Model #	Description
MLBX78	78" REDSTICK™ Box Level
MLBXM78	78" REDSTICK™ Magnetic Box Level
MLBX96	96" REDSTICK™ Box Level
MLBXM96	96" REDSTICK™ Magnetic Box Level
MLBXS1648	16" / 48" REDSTICK™ Box Level Set
MLBXS48	24" / 48" REDSTICK™ Box Level Set
MLBXS48M	24" / 48" REDSTICK™ Magnetic Box Level Set
MLBXJB	78" / 32" REDSTICK™ Box Level Jamb Set
MLBXJBM	78" / 32" REDSTICK™ Magnetic Box Level Jamb Set
MLSB48	48" Level Bag
MLSB78	78" Level Bag
MLBXC48	4 Pc REDSTICK™ Starter Set
MLBXC78	5 Pc REDSTICK™ Master Set

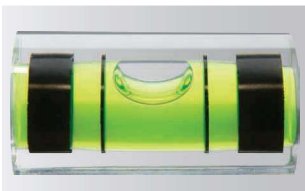

SHARPSITE™ Vial Technology

REDSTICK™ COMPACT BOX LEVELS

COMPACT DURABILITY

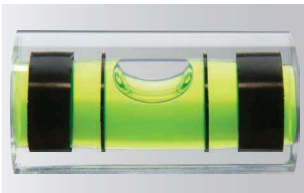

SHARPSITE™ Vial Technology

Model #	Description
MLCM24	24" REDSTICK™ Compact Box Level
MLCMM24	24" REDSTICK™ Magnetic Compact Box Level
MLCM48	48" REDSTICK™ Compact Box Level
MLCMM48	48" REDSTICK™ Magnetic Compact Box Level
MLCM72	72" REDSTICK™ Compact Box Level

Model #	Description
MLCMM72	72" REDSTICK™ Magnetic Compact Box Level
MLCMS48	24" / 48" REDSTICK™ Compact Box Level Set
MLCMSM48	24" / 48" REDSTICK™ Magnetic Compact Box Level Set

REDSTICK™ EXPANDABLE LEVELS

FRAME MORE. NO MAINTENANCE.



Reinforced Components & Durable Lock



Also Available:
Expandable Level Storage Bag
MLXPSB

Model #	Description
MLXPM78	48" – 78" REDSTICK™ Magnetic Expandable Level
MLXP712	6 1/2' – 12' REDSTICK™ Expandable Level

REDSTICK™ CONCRETE LEVELS

BUILT FOR CONCRETE



Screed



Smooth



Clean

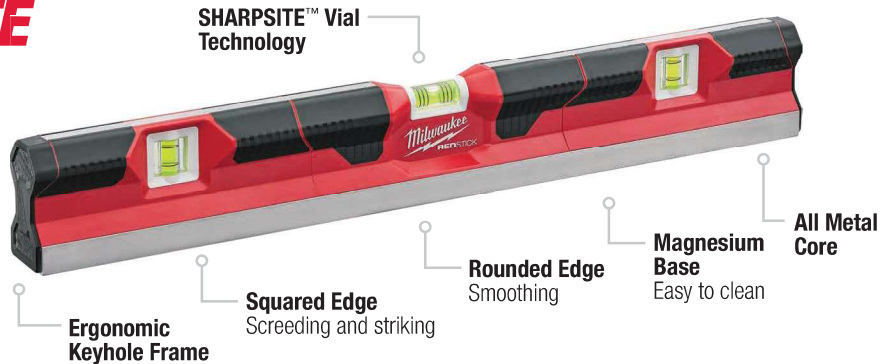

Model #	Description
MLCON24	24" REDSTICK™ Concrete Level
MLCON48	48" REDSTICK™ Concrete Level
MLCON72	72" REDSTICK™ Concrete Level

BILLET TORPEDO LEVELS

STRONGEST MAGNETS. EASIEST PITCH SET.

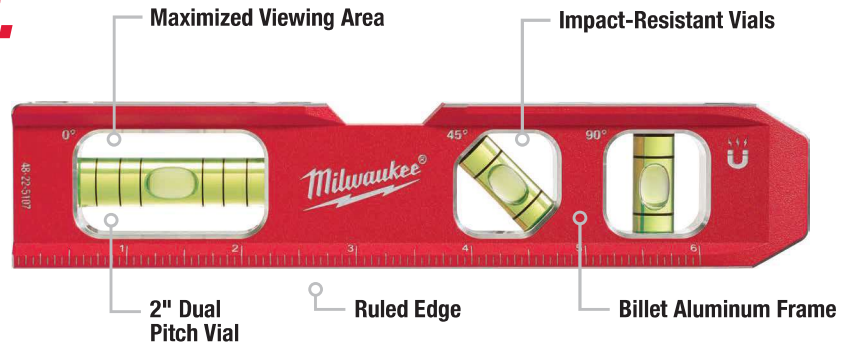

4 Amplified Rare-Earth Magnets

Model #	Description
48-22-5107	Billet Torpedo Level
48-22-5207	Metric Billet Torpedo Level

BLOCK TORPEDO LEVEL

STRONGEST MAGNETS. 360° ACCURACY.

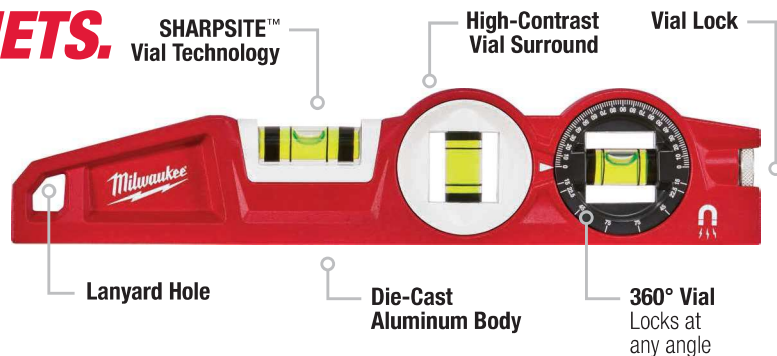

Amplified Rare-Earth Magnets

Model #	Description
48-22-5210	Block Torpedo Level
48-22-5102	360° Pocket Level

Model #	Description
48-22-5603	Pocket Level
48-22-5001	Pipe Lock Level

RAFTER SQUARES

**STRONGER FRAME.
MOST VERSATILE.**

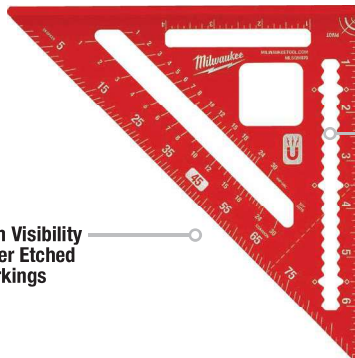

High Visibility Laser Etched Markings

Scribe Notches

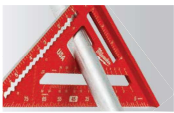

1" Cutout Props Pipe

Model #	Description
MLSQM070	7" Magnetic Rafter Square
MLSQ170	180mm Rafter Square

TRIM SQUARE

**MOST COMPACT.
MOST VERSATILE.**



High Visibility Laser Etched Markings

Scribe Notches



Dual Reference Heel

Model #	Description
MLSQ040	4 1/2" Trim Square

FRAMING SQUARES

**STRONGER THAN STEEL.
MOST VERSATILE.**

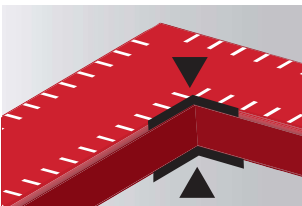

Thicker Frame

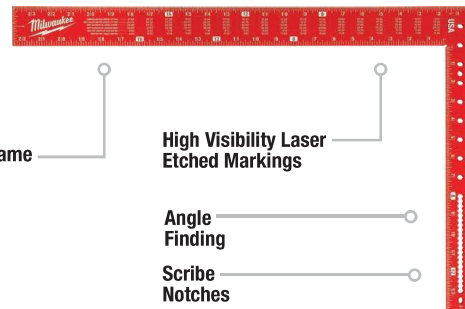

Reinforced Frame

High Visibility Laser Etched Markings

Angle Finding

Scribe Notches

Model #	Description
MLSQ024	16" x 24" Framing Square
MLSQ124	400mm x 600mm Framing Square

LASER DISTANCE METERS

**EASIEST
MEASUREMENTS**



Simplified User Interface

2" Backlit Color Screen

Continuous Real-Time Measurements

2-Position Auto-Detecting Lever



Impact-Resistant Overmolding

Side-Shot Button
Allows for one-handed measurement in all situations

Also Available:



65ft Laser Distance Meter
48-22-9801

Model #	Description
48-22-9801	65ft Laser Distance Meter
48-22-9802	150ft Laser Distance Meter

Model #	Description
48-22-9803	330ft Laser Distance Meter

FOLDING RULES

MOST DURABLE MARKINGS & BLADES

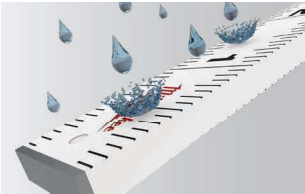

Water & Scratch Resistant Laminate

Quick Reference Bend Angles
22.5°, 30°, 45° & 60°

Heat-Stamped Markings
Won't wear

Corrosion-Free Embedded Joints
Locks at 0°, 90° & 180°



Model #	Description
48-22-3801	6-1/2ft Composite Folding Rule
48-22-3802	6-1/2ft Engineer's Composite Folding Rule

CHALK REELS

LONGEST GEAR LIFE. BEST PERFORMANCE.



StripGuard™ Clutch & Planetary Gears



Bold Line

1.5mm High-Strength Braided Line

6X Faster Retraction



Fine Line

0.9mm High-Strength Braided Line

Aluminum Body
Fine line model only

Model #	Description
48-22-3980	Bold Line Chalk Reel
48-22-3982	Bold Line Chalk Reel & Blue Chalk Refill
48-22-3986	Bold Line Chalk Reel & Red Chalk Refill
48-22-3989	Bold Replacement Line

Model #	Description
48-22-3990	Fine Line Chalk Reel
48-22-3992	Fine Line Chalk Reel & Blue Chalk Refill
48-22-3993	Chalk Reel Kit with Blue Chalk Refill
48-22-3999	Fine Replacement Line

EXTRA BOLD LARGE CAPACITY CHALK REELS

LONGEST GEAR LIFE. BEST PERFORMANCE.



Planetary Gears Prevent Stripping

24oz Chalk Capacity

4:1 Retraction Speed

Refillable Base



Easy Grip Metal Handle

Quick Turn Opening

Model #	Description
48-22-3910	100ft Extra Bold Large Capacity Chalk Reel
48-22-3900	100ft Extra Bold Replacement Line

Model #	Description
48-22-3915	150ft Extra Bold Large Capacity Chalk Reel
48-22-3905	150ft Extra Bold Replacement Line

INKZALL™ JOBSITE MARKERS

**WRITES ON
DUST
WET
OILY
SURFACES**



Clog Resistant



Model #	Description
48-22-3150	12 Pc INKZALL™ Ultra Fine Point Black Jobsite Markers
48-22-3154	4 Pc INKZALL™ Ultra Fine Point Black Jobsite Markers
48-22-3104	4 Pc INKZALL™ Fine Point Black Jobsite Markers
48-22-3105	2 Pc INKZALL™ Fine Point Black Jobsite Markers
48-22-3107	8 Pc INKZALL™ Fine Point Color Jobsite Markers
48-22-3106	4 Pc INKZALL™ Fine Point Color Jobsite Markers
48-22-3101	INKZALL™ Stylus and Fine Point Black Jobsite Markers
48-22-3102	2 Pc INKZALL™ Medium Point Black Jobsite Markers
48-22-3103	INKZALL™ Chisel Tip Black Jobsite Markers
48-22-3109	4 Pc INKZALL™ Chisel Tip Color Jobsite Markers
48-22-3100	INKZALL™ Fine Point Black Jobsite Markers (Bulk 36 Pc)
48-22-3130	INKZALL™ Chisel Tip Black Jobsite Markers (Bulk 36 Pc)

Model #	Description
48-22-3170	INKZALL™ Fine Point Red Jobsite Markers (Bulk 36 Pc)
48-22-3180	INKZALL™ Fine Point Blue Jobsite Markers (Bulk 36 Pc)
48-22-3190	INKZALL™ Fine Point Green Jobsite Markers (Bulk 36 Pc)
48-22-3209	12 Pc INKZALL™ Fine Point Black Jobsite Markers
48-22-3250	3 Pc INKZALL™ Large Chisel Tip Black Jobsite Markers
48-22-3255	INKZALL™ Large Chisel Tip Black Jobsite Markers (Bulk 12 Pc)
48-22-3256	INKZALL™ Large Chisel Tip Red Jobsite Markers (Bulk 12 Pc)
48-22-3257	INKZALL™ Large Chisel Tip Blue Jobsite Markers (Bulk 12 Pc)
48-22-3260	INKZALL™ Extra Large Chisel Tip Black Jobsite Markers
48-22-3265	INKZALL™ Extra Large Chisel Tip Black Jobsite Markers (Bulk 12 Pc)
48-22-3266	INKZALL™ Extra Large Chisel Tip Red Jobsite Markers (Bulk 12 Pc)
48-22-3267	INKZALL™ Extra Large Chisel Tip Blue Jobsite Markers (Bulk 12 Pc)

INKZALL™ METALLIC MARKERS



Visible On Dark Surfaces



Model #	Description
48-22-3121	2 Pc INKZALL™ Fine Point Silver Metallic Marker
48-22-3122	2 Pc INKZALL™ Fine Point Gold Metallic Marker
48-22-3123	2 Pc INKZALL™ Fine Point Silver/Gold Metallic Marker

INKZALL™ LIQUID PAINT MARKERS

BLEED & SMEAR RESISTANT

10-Second Dry Time

Valve Activated

Acrylic Nib

Water & UV Resistant Markings

Medium Point



Marks on Surfaces up to 300°F



Model #	Description
48-22-3712	INKZALL™ Medium Point White Liquid Paint Marker
48-22-3722	INKZALL™ Medium Point Yellow Liquid Paint Marker
48-22-3711	INKZALL™ Medium Point White Liquid Paint Marker (Bulk 12 Pc)
48-22-3721	INKZALL™ Medium Point Yellow Liquid Paint Marker (Bulk 12 Pc)
48-22-3731	INKZALL™ Medium Point Black Liquid Paint Marker (Bulk 12 Pc)

Model #	Description
48-22-3741	INKZALL™ Medium Point Red Liquid Paint Marker (Bulk 12 Pc)
48-22-3751	INKZALL™ Medium Point Green Liquid Paint Marker (Bulk 12 Pc)
48-22-3761	INKZALL™ Medium Point Blue Liquid Paint Marker (Bulk 12 Pc)
48-22-3771	INKZALL™ Medium Point Orange Liquid Paint Marker (Bulk 12 Pc)

INKZALL™ JOBSITE PENS

SHARP, PRECISE LINES

Clog Resistant Tip



Ultra Fine Point



Model #	Description
48-22-3160	12 Pc INKZALL™ Ultra Fine Point Black Jobsite Pen
48-22-3161	12 Pc INKZALL™ Ultra Fine Point Red Jobsite Pen
48-22-3162	12 Pc INKZALL™ Ultra Fine Point Blue Jobsite Pen
48-22-3164	4 Pc INKZALL™ Ultra Fine Point Black Jobsite Pen
48-22-3165	4 Pc INKZALL™ Ultra Fine Point Color Jobsite Pen

INKZALL™ JOBSITE HIGHLIGHTERS

UP TO 4X LONGER LIFE

Lanyard Hole

Hard Hat Clip



Chisel Tip

Anti-Roll Body



Model #	Description
48-22-3201	5 Pc INKZALL™ Chisel Tip Yellow Jobsite Highlighter
48-22-3206	5 Pc INKZALL™ Chisel Tip Colored Jobsite Highlighter

COMFORT GRIP STRAIGHT JAW PLIERS

REAM AND PUNCH™



Ream

Punch



Model #	Description	Jaw Capacity	Reaming Capacity
48-22-6306	6" Comfort Grip Straight Jaw Pliers	1"	3/4"
48-22-6310	10" Comfort Grip Straight Jaw Pliers	2"	2"
48-22-6312	12" Comfort Grip Straight Jaw Pliers	2-1/4"	2-3/4"
48-22-6316	16" Comfort Grip Straight Jaw Pliers	4-1/4"	3"
48-22-6320	20" Comfort Grip Straight Jaw Pliers	5-1/2"	3-1/2"
48-22-6330	2 Pc 6" & 10" Comfort Grip Straight Jaw Pliers Set	1" & 2"	3/4" & 2"
48-22-6331	3 Pc Comfort Grip Pliers Set	2"	2"

STRAIGHT JAW PLIERS

MAXIMUM GRIP. FORGED STRENGTH.



Dipped Grips



Reaming Head

Model #	Description	Jaw Capacity	Reaming Capacity
48-22-6510	10" Straight Jaw Pliers	2"	2"
48-22-6512	12" Straight Jaw Pliers	2-1/4"	2-3/4"

SMOOTH JAW PLIERS

SMOOTH JAW PROTECTS SURFACES



Dipped Grips

Reaming Head



Non-Marring Smooth Jaw for Finish Applications

Model #	Description	Jaw Capacity	Reaming Capacity
48-22-6550	10" Smooth Jaw Pliers	2"	2"
48-22-6552	12" Smooth Jaw Pliers	2-1/4"	2-3/4"

V-JAW PLIERS



HEX JAW
BEST FIT. STRONG HOLD.

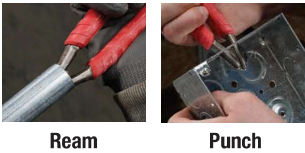

Ream

Punch



Slim Design Head

Reaming Handles

Reaming Head

All-Metal Quick Adjust

Comfort Grips Will not peel

Punching Handles

Model #	Description	Jaw Capacity	Reaming Capacity
48-22-6208	8" Comfort Grip V-Jaw Pliers	1-1/2"	1-1/2"
48-22-6210	10" Comfort Grip V-Jaw Pliers	2"	2"
48-22-6212	12" Comfort Grip V-Jaw Pliers	2-3/4"	2-3/4"

LINEMAN'S PLIERS

MAXIMUM LEVERAGE.
EASIER CUTS.*



Easily Cuts #2 ACSR
* When compared to other ACSR cutting lineman pliers



Crimper

Wire Cutter

Dipped Grips

Also Available:



Comfort Grip High-Leverage Lineman's Pliers
48-22-6100

Model #	Description
48-22-6100	Comfort Grip High-Leverage Lineman's Pliers with Crimper
48-22-6500	High-Leverage Lineman's Pliers with Crimper
48-22-6502	High-Leverage Lineman's Pliers
48-22-6503	High-Leverage Lineman's Pliers with Thread Cleaner

ANGLED HEAD PLIERS

BETTER ACCESS



Angled Head



Comfort Grips Will not peel

Also Available:



8" Angled Head Diagonal Cutting Pliers
48-22-6528

Model #	Description
48-22-6128	8" Comfort Grip Angled Head Diagonal Cutting Pliers
48-22-6528	8" Angled Head Diagonal Cutting Pliers

LONG NOSE PLIERS

LONG REACH



2" Gripping Nose

Also Available:



8" Long Nose Pliers
48-22-6501

Model #	Description
48-22-6101	8" Comfort Grip Long Nose Pliers
48-22-6501	8" Long Nose Pliers

DIAGONAL PLIERS

UP TO 2X MORE CUTS

IRON-CARBIDE EDGE



Tapered Nose

Also Available:



8" Diagonal Cutting Pliers
48-22-6508

Model #	Description
48-22-6106	6" Comfort Grip Diagonal Cutting Pliers
48-22-6107	7" Comfort Grip Diagonal Cutting Pliers
48-22-6108	8" Comfort Grip Diagonal Cutting Pliers
48-22-6508	8" Diagonal Cutting Pliers

6 IN 1 COMBINATION PLIERS

6IN1



Model #	Description	Wire Stripper
48-22-3079	6IN1 Comfort Grip Combination Pliers	8-18 AWG Solid, 10-20 AWG Stranded

MULTI-FUNCTION PLIERS

FAST, ONE-HANDED OPERATION

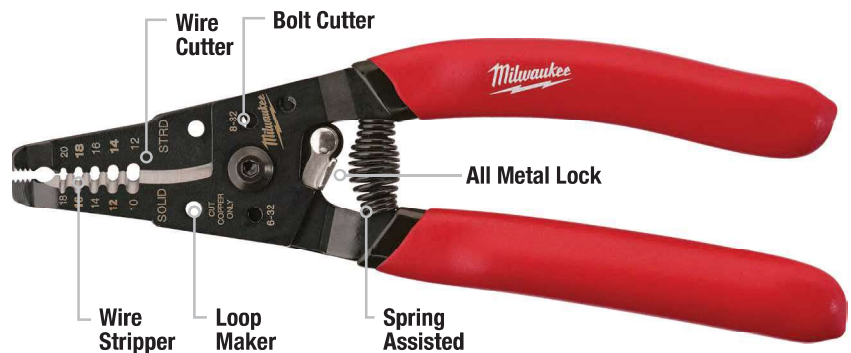

Model #	Description	Wire Stripper
48-22-6109	Wire Stripper	10-18 AWG Solid, 12-20 AWG Stranded
48-22-6579	Multi-Purpose Wire Stripper with Crimper	10-20 AWG Solid, 12-22 AWG Stranded

IRONWORKER'S PLIERS

UP TO **2X MORE CUTS**

IRON-CARBIDE EDGE



Comfort Grips
Will not peel



For Twisting & Cutting Rebar Ties

Model #	Description
48-22-6102	Ironworker's Pliers

CRIMPING PLIERS

UP TO **2X CRIMPING FORCE**



Reaming Head Wire Cutter

Comfort Grips
Will not peel



Crimper for Insulated & Non-Insulated Terminals

Model #	Description
48-22-6103	Crimping Pliers

CABLE CUTTING PLIERS

CLEAN CUTS



Comfort Grips
Will not peel



Cuts up to 2/0 Cu, 4/0 Al

Model #	Description
48-22-6104	Cable Cutting Pliers

PVC / OIL FILTER PLIERS

3-1/2" JAW CAPACITY



Comfort Grips
Will not peel



Model #	Description
48-22-6321	PVC / Oil Filter Pliers

NIPPING PLIERS

CURVED HEAD PROTECTS SURFACES



Comfort Grips
Will not peel



Blades Will Not Mar Surfaces

Model #	Description
48-22-6407	7" Nipping Pliers

FENCING PLIERS

FORGED STRENGTH

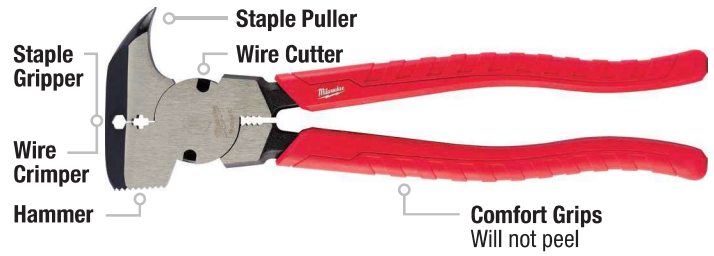

Staple Puller
Wire Cutter
Wire Crimper
Hammer

Comfort Grips
Will not peel



Wire Puller

Model #	Description
48-22-6410	Fencing Pliers

TORQUE LOCK™ FASTER SET-UP



LOCKING PLIERS WITH MAX BITE™

MAX BITE™ 3X GRIPPING FORCE



CHROME
Chrome plated rust protection



GRIPPED
Rubber overmold

Model #	Description
48-22-3607	7" MAX BITE™ Curved Jaw Locking Pliers
48-22-3610	10" MAX BITE™ Curved Jaw Locking Pliers
48-22-3702	2 Pc 7" & 10" Locking Pliers with MAX BITE™

Model #	Description
48-22-3710	10" Locking Pliers with Grip with MAX BITE™
48-22-3707	7" Locking Pliers with Grip with MAX BITE™

LOCKING PLIERS



CURVED JAW
Maximizes pressure points for any bolt, nut or locking tool application



STRAIGHT JAW
Maximizes contact points on jobsite work surfaces



LONG NOSE
Best for long reach applications

Model #	Description
48-22-3405	5" TORQUE LOCK™ Curved Jaw Locking Pliers with Grip
48-22-3407	7" TORQUE LOCK™ Curved Jaw Locking Pliers with Grip
48-22-3410	10" TORQUE LOCK™ Curved Jaw Locking Pliers with Grip
48-22-3406	6" TORQUE LOCK™ Long Nose Locking Pliers with Grip
48-22-3409	9" TORQUE LOCK™ Long Nose Locking Pliers with Grip
48-22-3807	7" TORQUE LOCK™ Straight Jaw Locking Pliers with Grip
48-22-3810	10" TORQUE LOCK™ Straight Jaw Locking Pliers with Grip
48-22-3402	2 Pc 7" & 10" TORQUE LOCK™ Curved Jaw Locking Pliers with Grip Set
48-22-3602	2 Pc. 10" Curved Jaw & 6" Long Nose TORQUE LOCK™ Locking Pliers Set
48-22-3423	4" TORQUE LOCK™ Curved Jaw Locking Pliers

Model #	Description
48-22-3422	5" TORQUE LOCK™ Curved Jaw Locking Pliers
48-22-3421	7" TORQUE LOCK™ Curved Jaw Locking Pliers
48-22-3420	10" TORQUE LOCK™ Curved Jaw Locking Pliers
48-22-3504	4" TORQUE LOCK™ Long Nose Locking Pliers
48-22-3506	6" TORQUE LOCK™ Long Nose Locking Pliers
48-22-3507	7" TORQUE LOCK™ Straight Jaw Locking Pliers
48-22-3509	9" TORQUE LOCK™ Long Nose Locking Pliers
48-22-3510	10" TORQUE LOCK™ Straight Jaw Locking Pliers
48-22-3541	12" TORQUE LOCK™ Large Jaw Locking Pliers

C-CLAMPS & SPECIALTY

STANDARD JAW C-CLAMP

Greater clamping versatility on a variety of shapes and surfaces



Model #	Description
48-22-3521	11" Swivel Jaw Locking C-Clamp
48-22-3522	6" Swivel Jaw Locking C-Clamp
48-22-3531	11" Locking C-Clamp
48-22-3532	6" Locking C-Clamp
48-22-3520	18" Swivel Jaw Locking C-Clamp
48-22-3529	18" Deep Reach Locking C-Clamp
48-22-3530	18" Locking C-Clamp

SWIVEL JAW C-CLAMP

Pads provide surface stabilization and protect work surfaces from damage



Model #	Description
48-22-3540	8" Locking Seamer
48-22-3542	9" Locking Chain Wrench
48-22-3543	9" Locking Welding Clamp
48-22-3523	9" Deep Reach Swivel Jaw Locking C-Clamp
48-22-3533	9" Deep Reach Locking C-Clamp
48-22-3631	11" Locking C-Clamp
48-22-3632	6" Locking C-Clamp

CHEATER ADAPTABLE PIPE WRENCH

3 LENGTH DESIGN

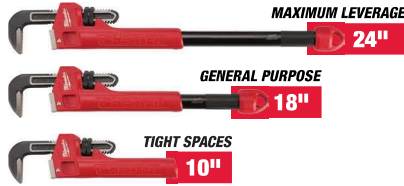

Model #	Description	Material	Max Jaw Capacity
48-22-7314	CHEATER Adaptable Pipe Wrench	Steel	2-1/2"

10L ALUMINUM PIPE WRENCH WITH POWERLENGTH™ HANDLE

**BETTER ACCESS.
MAXIMUM LEVERAGE.**



Model #	Description	Material	Max Jaw Capacity
48-22-7313	10L Aluminum Pipe Wrench w/POWERLENGTH™ Handle	Aluminum	1-1/2"

STEEL & ALUMINUM PIPE WRENCHES

LARGEST GRIP SURFACE



Steel



Aluminum

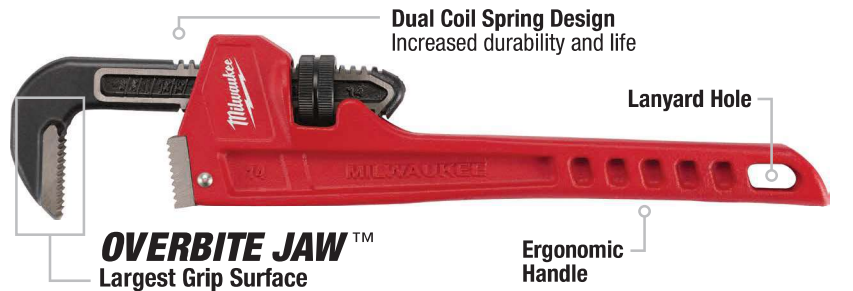

Model #	Description	Length	Material	Max Jaw Capacity	Model #	Description	Length	Material	Max Jaw Capacity
48-22-7106	6" Steel Pipe Wrench	6"	Steel	3/4"	48-22-7148	48" Steel Pipe Wrench	48"	Steel	6"
48-22-7108	8" Steel Pipe Wrench	8"	Steel	1"	48-22-7160	60" Steel Pipe Wrench	60"	Steel	8"
48-22-7110	10" Steel Pipe Wrench	10"	Steel	1-1/2"	48-22-7210	10" Aluminum Pipe Wrench	10"	Aluminum	1-1/2"
48-22-7112	12" Steel Pipe Wrench	12"	Steel	2"	48-22-7212	12" Aluminum Pipe Wrench	12"	Aluminum	2"
48-22-7114	14" Steel Pipe Wrench	14"	Steel	2"	48-22-7214	14" Aluminum Pipe Wrench	14"	Aluminum	2"
48-22-7118	18" Steel Pipe Wrench	18"	Steel	2-1/2"	48-22-7218	18" Aluminum Pipe Wrench	18"	Aluminum	2-1/2"
48-22-7124	24" Steel Pipe Wrench	24"	Steel	3"	48-22-7224	24" Aluminum Pipe Wrench	24"	Aluminum	3"
48-22-7136	36" Steel Pipe Wrench	36"	Steel	5"	48-22-7236	36" Aluminum Pipe Wrench	36"	Aluminum	5"
					48-22-7248	48" Aluminum Pipe Wrench	48"	Aluminum	6"

STEEL OFFSET HEX PIPE WRENCH

SMOOTH JAW WON'T MAR SURFACES

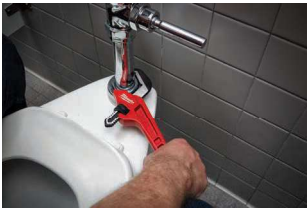

Protects Chrome Surfaces



Model #	Description	Material	Max Jaw Capacity
48-22-7171	Steel Offset Hex Pipe Wrench	Steel	2-5/8"

STEEL SMOOTH JAW PIPE WRENCH

SMOOTH JAW PROTECTS SURFACES



Protects Chrome Surfaces



Model #	Description	Material	Max Jaw Capacity
48-22-7186	12" Steel Smooth Jaw Pipe Wrench	Steel	2-5/8"

ALUMINUM OFFSET HEX PIPE WRENCHES

BETTER ACCESS



Offset Head



Model #	Description	Material	Max Jaw Capacity
48-22-7184	14" Aluminum Offset Pipe Wrench	Aluminum	2"
48-22-7185	18" Aluminum Offset Pipe Wrench	Aluminum	2"
48-22-7182	24" Aluminum Offset Pipe Wrench	Aluminum	3"

ADJUSTABLE WRENCHES

**JAWS WON'T
BACK OFF**
Proprietary Screw

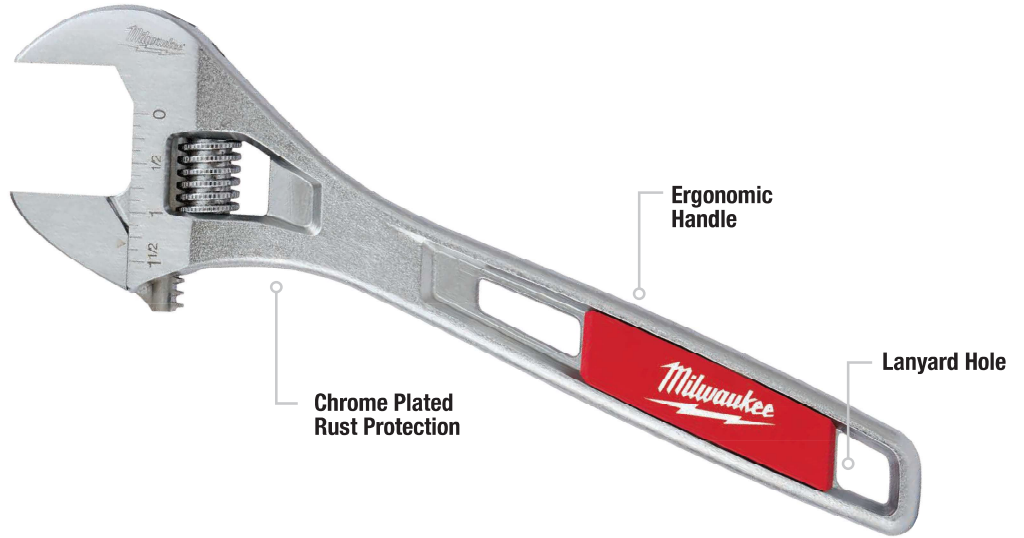

Perfectly Parallel Jaws

Model #	Description
48-22-7400	2 Pc 6" & 10" Adjustable Wrench Set
48-22-7406	6" Adjustable Wrench
48-22-7408	8" Adjustable Wrench
48-22-7410	10" Adjustable Wrench
48-22-7412	12" Adjustable Wrench
48-22-7415	15" Adjustable Wrench
48-22-7508	8" Wide Jaw Adjustable Wrench

BASIN WRENCHES

**EASIEST
SWAP-OUTS**



Ratchet-Ready
Less jaw readjusting



Screwdriver-Ready
Up to 2x breakaway torque

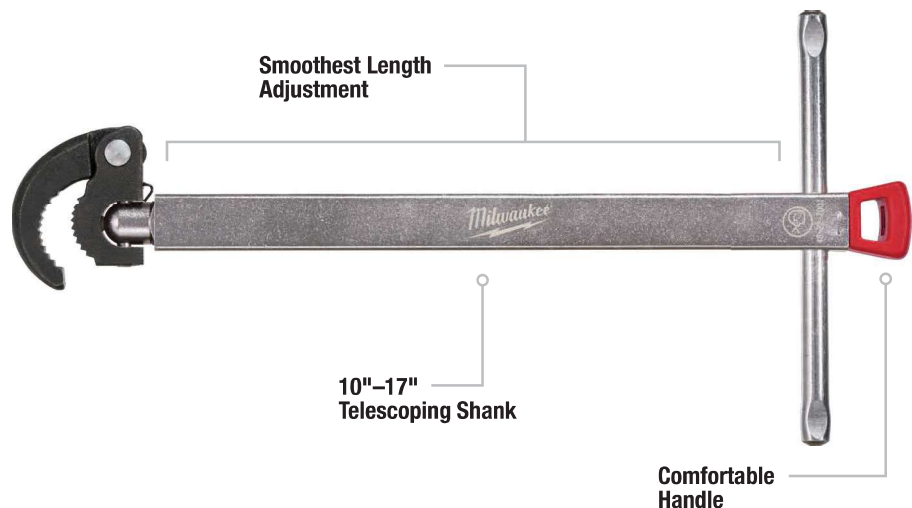

Model #	Description
48-22-7001	1-1/4" Basin Wrench
48-22-7002	2-1/2" Basin Wrench

CONTRACTOR RATCHET & SOCKET SETS

**VERSATILE DESIGN.
BETTER ACCESS.**

SAE **METRIC**



FOUR FLAT™ SIDES
Anti-Roll, Wrench-Ready.

Slim Design



Pivoting Head

Model #	Description
48-22-9000	12 Pc 3/8" SAE Contractor Ratchet & Socket Set with FOUR FLAT™ Sides
48-22-9001	12 Pc 3/8" Metric Contractor Ratchet & Socket Set with FOUR FLAT™ Sides

MECHANICS RATCHET & SOCKET SETS

**MOST VERSATILE SOCKETS.
ANTI-ROLL, WRENCH-READY.**

SAE **METRIC**



FOUR FLAT™ SIDES
Anti-Roll, Wrench-Ready.



Stamped Sizes
Better visibility

90 Tooth Design

Slim Design

4° Arc Swing

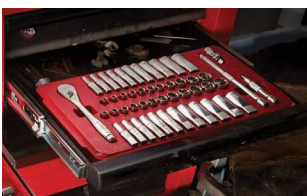

Removable Storage Trays

MET Part #	Description
48-22-9404	26 Pc 1/4" SAE Drive Ratchet & Sockets with FOUR FLAT™ Sides
48-22-9408	28 Pc 3/8" SAE Drive Ratchet & Sockets with FOUR FLAT™ Sides
48-22-9504	28 Pc 1/4" Metric Drive Ratchet & Sockets with FOUR FLAT™ Sides
48-22-9014	1/4" Drive Ratchet
48-22-9508	32 Pc 3/8" Metric Drive Ratchet & Sockets with FOUR FLAT™ Sides
48-22-9004	50 Pc Metric & SAE 1/4" Drive Ratchet & Sockets with FOUR FLAT™ Sides
48-22-9008	56 Pc Metric & SAE 3/8" Drive Ratchet & Sockets with FOUR FLAT™ Sides
48-22-9038	3/8" Drive Ratchet

RATCHETING COMBINATION WRENCHES

**BETTER ACCESS.
LONGEST LIFE.**



Durable Double Stacked Pawls

Model #	Description	Included Sizes
48-22-9406	7 Pc SAE Ratcheting Combination Wrench Set	3/8", 7/16", 1/2", 9/16", 5/8", 11/16", 3/4"
48-22-9506	7 Pc Metric Ratcheting Combination Wrench Set	8mm, 10mm, 12mm, 13mm, 14mm, 15mm, 17mm
48-22-9416	15 Pc SAE Ratcheting Combination Wrench Set	1/4", 9/32", 5/16", 11/32", 3/8", 7/16", 1/2", 9/16", 5/8", 11/16", 3/4", 13/16", 7/8", 15/16", 1"
48-22-9516	15 Pc Metric Ratcheting Combination Wrench Set	8mm, 9mm, 10mm, 11mm, 12mm, 13mm, 14mm, 15mm, 16mm, 17mm, 18mm, 19mm, 20mm, 21mm, 22mm

COMBINATION WRENCHES

**UP TO
25% MORE TORQUE**



Innovative Storage Solution

Model #	Description	Included Sizes
48-22-9407	7 Pc SAE Combination Wrench Set	3/8", 7/16", 1/2", 9/16", 5/8", 11/16", 3/4"
48-22-9507	7 Pc Metric Combination Wrench Set	8mm, 10mm, 12mm, 13mm, 14mm, 15mm, 17mm
48-22-9415	15 Pc SAE Combination Wrench Set	1/4", 9/32", 5/16", 11/32", 3/8", 7/16", 1/2", 9/16", 5/8", 11/16", 3/4", 13/16", 7/8", 15/16", 1"
48-22-9515	15 Pc Metric Combination Wrench Set	8mm, 9mm, 10mm, 11mm, 12mm, 13mm, 14mm, 15mm, 16mm, 17mm, 18mm, 19mm, 20mm, 21mm, 22mm

PRY BARS

**UP TO
40% MORE PRYING STRENGTH**

I-BEAM DESIGN

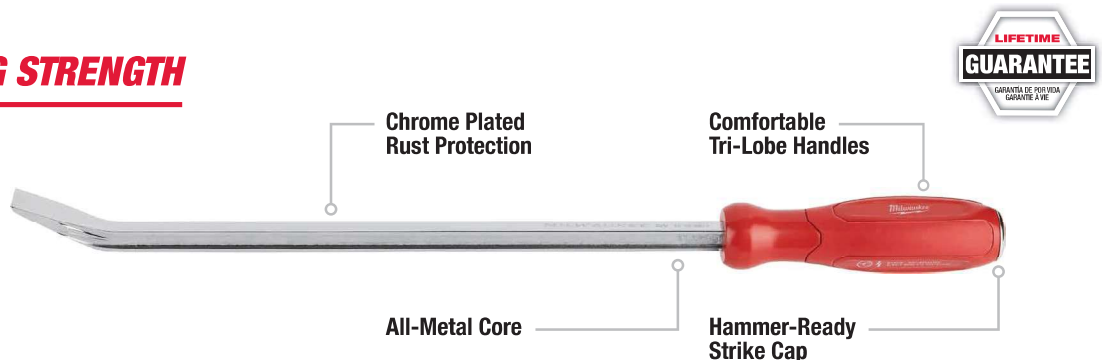

Easy Access Storage Tray

Model #	Description	Included Lengths
48-22-9214	4 Pc Pry Bar Set	8", 12", 18", 24"

HOOK AND PICK SET & MULTI-BIT DRIVERS

HOOK AND PICK SET

UP TO
50% MORE DURABLE

ALL-METAL CORE



Easy Access Storage Tray

Model #	Description	Includes
48-22-9215	4 Pc Hook and Pick Set	Straight Pick, Offset Hook, Hook, 90° Hook

9 IN 1 MULTI-BIT / KEY DRIVERS

9IN1

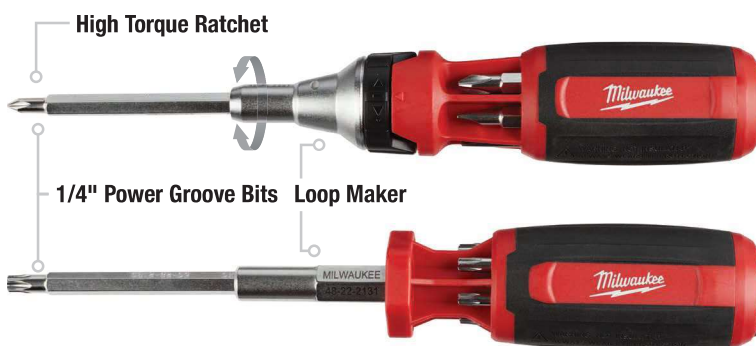

Power Tool Compatibility



In-Handle Storage

Model #	Description	Nut Drivers	Bit Types
48-22-2131	9IN1 Multi-Bit Driver w/ ECX™	1/4"	P#1, P#2, SL 3/16", SL 1/4", SQ#2, ECX™#1, ECX™#2
48-22-2132	9IN1 Square Multi-Bit Driver	1/4"	P#1, P#2, SL 3/16", SL 1/4", SQ#1, SQ#2, SQ#3
48-22-2331	9IN1 Ratchet Multi-Bit Driver w/ ECX™	1/4"	P#1, P#2, SL 3/16", SL 1/4", SQ#2, ECX™#1, ECX™#2
48-22-2322	9IN1 Ratchet Multi-Bit Driver w/ Square	1/4"	P#1, P#2, SL 3/16", SL 1/4", SQ#1, SQ#2, SQ#3
48-22-2133	9IN1 TORX® Key Driver	1/4"	T8, T10, T15, T20, T25, T27, T30
48-22-2134	9IN1 SAE Hex Key Driver	1/4"	7/64", 1/8", 9/64", 5/32", 3/16", 7/32", 1/4"
48-22-2136	9IN1 Metric Hex Key Driver	1/4"	1.5mm, 2mm, 2.5mm, 3mm, 4mm, 5mm, 6mm
48-22-2110	4 Pc Replacement Bit Set		P#1, P#2, SL 3/16", SL 1/4", SQ #1, SQ#1, ECX™#1

8 IN 1 COMPACT MULTI-BIT DRIVERS

8IN1



Power Tool Compatibility



In-Handle Storage



Model #	Description	Nut Drivers	Bit Types
48-22-2130	Compact 8IN1 Multi-Bit Driver	1/4"	P#1, P#2, SL 3/16", SL 1/4", SQ#1, SQ#2, T15
48-22-2330	Compact 8IN1 Ratchet Multi-Bit Driver	1/4"	P#1, P#2, SL 3/16", SL 1/4", SQ#1, SQ#2, T15

11 IN 1 MULTI-BIT DRIVERS

11in1



Comfortable Tri-Lobe Handle

Model #	Description	Nut Drivers	Bit Types
48-22-2760	11in1 Multi-Bit Driver w/ ECX™	1/4", 5/16", 3/8"	P#1, P#2, SL 3/16", SL 1/4", SQ#1, SQ#2, ECX™#1, ECX™#2
48-22-2761	11in1 Multi-Bit Driver w/ TORX®	1/4", 5/16", 3/8"	P#1, P#2, SL 3/16", SL 1/4", SQ#1, SQ#2, T10, T15

13 IN 1 CUSHION-GRIP SCREWDRIVERS

13in1

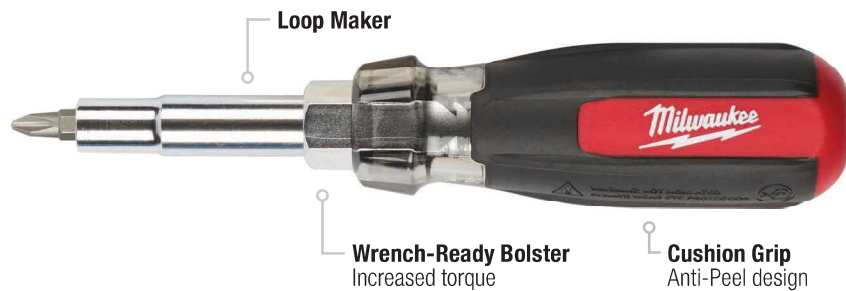

ECX™ Bit



Schrader® Valve Core Remover

Model #	Description	Nut Drivers	Bit Types
48-22-2880	13in1 Cushion-Grip Screwdriver with ECX™ Bit	1/4", 5/16", 3/8", 1/2"	P#1, P#2, SL 3/16", SL1/4", SQ#1, SQ#2, ECX™#1, ECX™#2
48-22-2881	13in1 Cushion-Grip Screwdriver with Schrader® Bit	1/4", 5/16", 3/8", 1/2"	P#1, P#2, SL 3/16", SL1/4", SQ#1, SQ#2, Std Schrader®, Large Schrader®

SCREWDRIVERS

**HIGH-LEVERAGE HANDLE.
MAGNETIC TIP.**

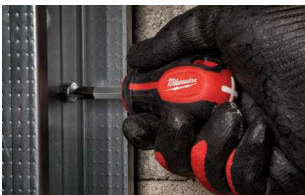

Comfortable Tri-Lobe Handle

Model #	Description	Bit Types
48-22-2702	2 Pc Demolition Screwdriver Set	P#2, SL 5/16"
48-22-2706	6 Pc Screwdriver Set	P#1, P#2, SL 3/16", SL 1/4", SL 5/16"
48-22-2708	8 Pc Screwdriver Set w/ ECX™	P#1, P#2, SL 3/16", SL 1/4", SL 5/16", ECX™ #1, ECX™ #2
48-22-2710	10 Pc Screwdriver Set	P#1, P#2, SL 3/16", SL 1/4", SL 5/16", SQ#1, SQ#2
48-22-2718	8 Pc Screwdriver Set w/ Square	P#1, P#2, SL 3/16", SL 1/4", SL 5/16", SQ#1, SQ#2
48-22-2700	Bottle Opener	

CUSHION-GRIP SCREWDRIVERS

**MOST DURABLE HANDLE.
PRECISION TIP.**

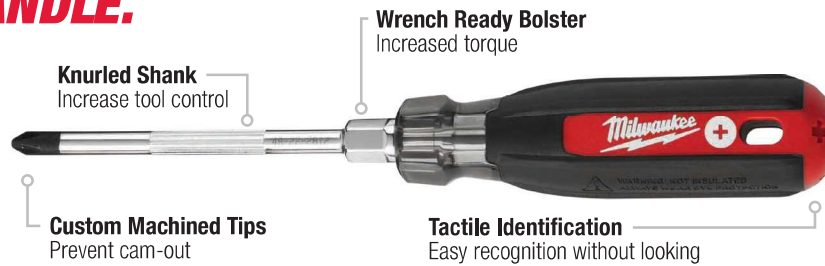

Anti-Peel Design Cushion Grips

Model #	Description
48-22-2811	#1 Phillips (3")
48-22-2812	#2 Phillips (4")
48-22-2813	#3 Phillips (6")
48-22-2814	#2 Phillips (10")
48-22-2815	#2 Phillips (6") Cushion-Grip Demolition Screwdriver

Model #	Description
48-22-2821	1/4" Slotted (4")
48-22-2822	5/16" Slotted (6")
48-22-2824	3/8" Slotted (8")
48-22-2831	3/16" Cabinet (3")
48-22-2832	3/16" Cabinet (6")
48-22-2833	3/16" Cabinet (8")
48-22-2834	1/4" Cabinet (10")

Model #	Description
48-22-2841	#1 ECX™ (4")
48-22-2842	#2 ECX™ (4")
48-22-2851	#1 Square (3")
48-22-2852	#2 Square (4")
48-22-2853	#3 Square (6")
48-22-2884	4 Pc Set
48-22-2886	6 Pc Set

DEMO DRIVER

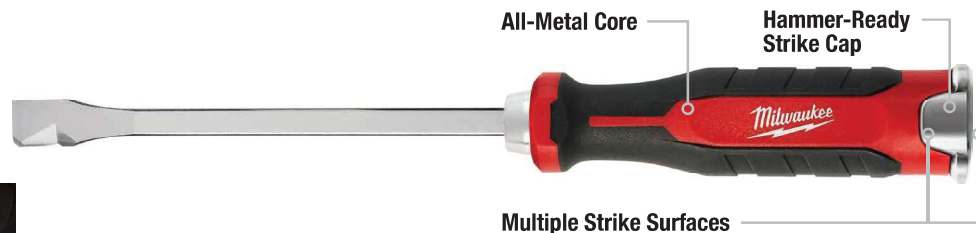

Aggressive Duct Piercing Tip

Model #	Description
48-22-2860	Demo Driver
48-22-2823	Slotted 5/16" 6" Cushion-Grip Demolition Screwdriver
48-22-2825	Slotted 3/8" 8" Cushion-Grip Demolition Screwdriver

1000V INSULATED SCREWDRIVERS



1000V
IEC 60900:2012 | ASTM F1505-10 | NFPA 70E

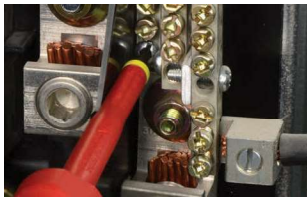

Slim Drive Shaft
Allows access in recessed applications

Model #	Description
48-22-2211	#1 Phillips (3")
48-22-2212	#2 Phillips (4")
48-22-2213	#3 Phillips (6")
48-22-2221	1/4" Slotted (6")
48-22-2222	5/16" Slotted (7")
48-22-2223	3/8" Slotted (8")
48-22-2224	3/8" Slotted (10")
48-22-2231	3/16" Cabinet (4")

Model #	Description
48-22-2232	3/16" Cabinet (6")
48-22-2233	3/16" Cabinet (8")
48-22-2241	#1 ECX™ (4")
48-22-2242	#2 ECX™ (4")
48-22-2251	#1 Square (3")
48-22-2252	#2 Square (4")
48-22-2253	#3 Square (6")

Model #	Description	Bit Types, Carrying Case
48-22-2202	3 Pc 1000V Insulated Screwdriver Set	P#2, SL 1/4", ECX™ #1
48-22-2204	4 Pc 1000V Insulated Screwdriver Set w/ Case	P#1, P#2, SL 1/4", SL 3/8", Extra Capacity Roll Up Pouch
48-22-2205	4 Pc 1000V Insulated Screwdriver Set w/ Case	SL 1/4", SL 3/8", SQ#1, SQ#2, Extra Capacity Roll Up Pouch
48-22-2210	10 Pc 1000V Insulated Screwdriver Set w/ Case	P#1, P#2, P#3, SL 1/4", SL 5/16", SL 3/8", SQ#1, SQ#2, SQ#3, ECX™ #1, EVA Foam Fitted Case
48-22-2203	3 Pc 1000V Insulated Screwdriver Set	#1 ECX™ (4"), #2 Phillips (4"), 1/4" Slotted (6")

PRECISION SCREWDRIVERS

UP TO **4x STRONGER**



360° Rotating & Impact Resistant Back Cap

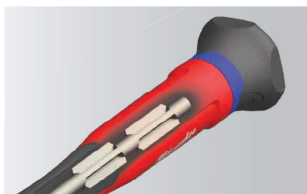

All-Metal Core

Model #	Description	Bit Types
48-22-2604	4 Pc Precision Screwdriver Set	P#1, SL 1/16", SL 3/32", SL 1/8"
48-22-2606	6 Pc Precision Screwdriver Set w/ Case	P#1, P#2, SL 1/16", SL 3/32", SL 1/8", SL 5/32"
48-22-2610	6 Pc TORX® Precision Screwdriver Set w/ Case	T6, T7, T8, T9, T10, T15

HOLLOWCORE™ MAGNETIC NUT DRIVERS

UNLIMITED DEPTH

FITS **4X** MORE FASTENERS



SAE **METRIC**

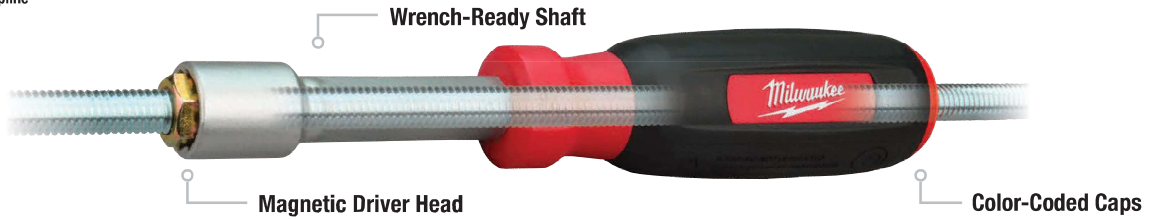

Model #	Description	Sizes
48-22-2502	2 Pc HOLLOWCORE™ Magnetic Nut Driver Set	1/4", 5/16"
48-22-2507	7 Pc HOLLOWCORE™ SAE Magnetic Nut Driver Set	1/4", 5/16", 11/32", 3/8", 7/16", 1/2", 9/16"
48-22-2517	7 Pc HOLLOWCORE™ Metric Magnetic Nut Driver Set	5mm, 5.5mm, 6mm, 7mm, 8mm, 10mm, 13mm

Model #	Description
48-22-2520	3/16" Magnetic Nut Driver
48-22-2521	1/4" HOLLOWCORE™ Magnetic Nut Driver
48-22-2522	5/16" HOLLOWCORE™ Magnetic Nut Driver
48-22-2523	11/32" HOLLOWCORE™ Magnetic Nut Driver
48-22-2524	3/8" HOLLOWCORE™ Magnetic Nut Driver

Model #	Description
48-22-2525	7/16" HOLLOWCORE™ Magnetic Nut Driver
48-22-2526	1/2" HOLLOWCORE™ Magnetic Nut Driver
48-22-2527	9/16" HOLLOWCORE™ Magnetic Nut Driver
48-22-2531	5mm HOLLOWCORE™ Magnetic Nut Driver
48-22-2532	5.5mm HOLLOWCORE™ Magnetic Nut Driver

Model #	Description
48-22-2533	6mm HOLLOWCORE™ Magnetic Nut Driver
48-22-2534	7mm HOLLOWCORE™ Magnetic Nut Driver
48-22-2535	8mm HOLLOWCORE™ Magnetic Nut Driver
48-22-2536	10mm HOLLOWCORE™ Magnetic Nut Driver
48-22-2537	13mm HOLLOWCORE™ Magnetic Nut Driver

HOLLOW SHAFT NUT DRIVERS

FITS **4X** MORE FASTENERS



SAE **METRIC**

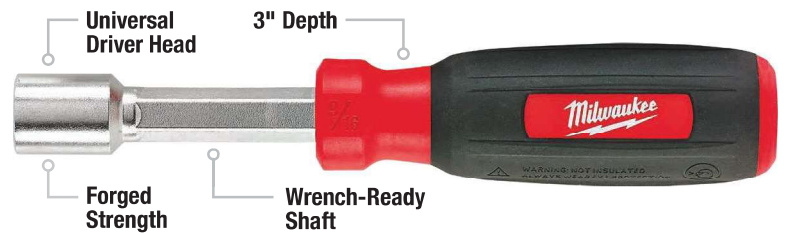

Model #	Description	Sizes
48-22-2402	2 Pc SAE Hollow Shaft Nut Driver Set	1/4", 5/16"
48-22-2404	4 Pc SAE Hollow Shaft Nut Driver Set	1/4", 5/16", 7/16", 9/16"
48-22-2407	7 Pc SAE Hollow Shaft Nut Driver Set	1/4", 5/16", 11/32", 3/8", 7/16", 1/2", 9/16"
48-22-2417	7 Pc Metric Hollow Shaft Nut Driver Set	5mm, 5.5mm, 6mm, 7mm, 8mm, 10mm, 13mm

Model #	Description
48-22-2420	3/16" Hollow Shaft Nut Driver
48-22-2421	1/4" Hollow Shaft Nut Driver
48-22-2422	5/16" Hollow Shaft Nut Driver
48-22-2423	11/32" Hollow Shaft Nut Driver
48-22-2424	3/8" Hollow Shaft Nut Driver

Model #	Description
48-22-2425	7/16" Hollow Shaft Nut Driver
48-22-2426	1/2" Hollow Shaft Nut Driver
48-22-2427	9/16" Hollow Shaft Nut Driver
48-22-2431	5mm Hollow Shaft Nut Driver
48-22-2432	5.5mm Hollow Shaft Nut Driver

Model #	Description
48-22-2433	6mm Hollow Shaft Nut Driver
48-22-2434	7mm Hollow Shaft Nut Driver
48-22-2435	8mm Hollow Shaft Nut Driver
48-22-2436	10mm Hollow Shaft Nut Driver
48-22-2437	13mm Hollow Shaft Nut Driver