

5

Connect 230V power feed to the terminal block of the luminaire.

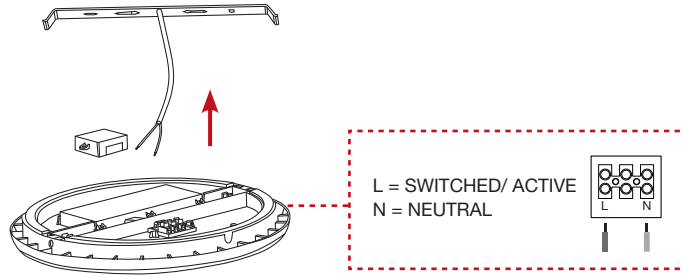

6

Secure luminaire with grub screws to mounting bracket.

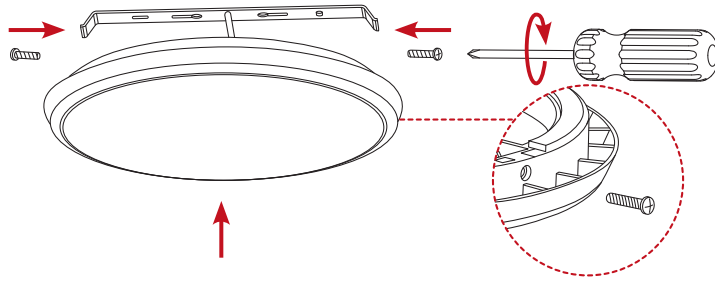

7

Restore power once installation has been completed.

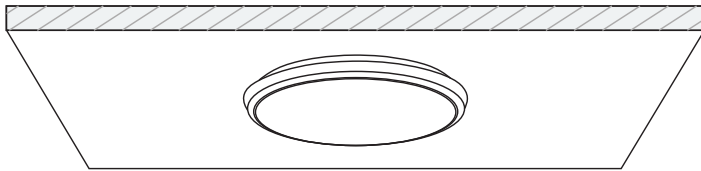

V2-01.03.2023 Product designs and technical data may be subject to change

Luna ST30 IK10 Rated Surface Mounted Tricolour LED Oyster *Installation Guide*

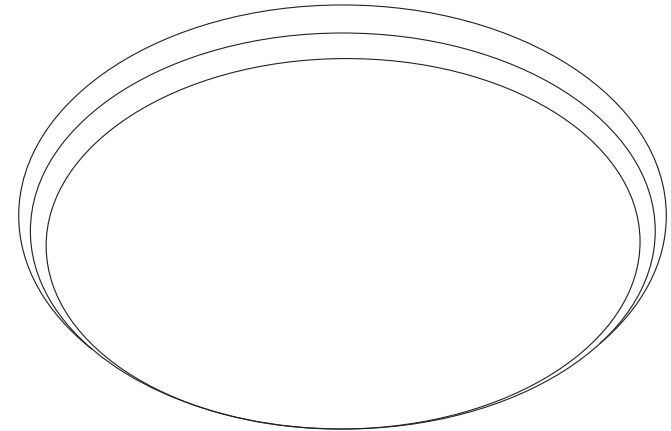

Scan to explore
ST30 online

trendlighting.com.au/series/trade

For warranty information, please visit

trendlighting.com.au/warranty

Important Safety Information

Please read these installation instructions carefully before installing this luminaire.

- This product must be installed by a licensed electrician in accordance with AS/NZS 3000 and local regulations.
- Isolate the mains power supply prior to installation.
- Only adjust the CCT switch when luminaire is powered off.
- Only reconnect mains power after installation is completed.
- No part of the luminaire should be altered or modified.
- This product is not user serviceable.

Installation Notes



Product Code

Dimensions

ST30-TRI-W-LT (White)	Ø400 x 52 (H) mm
ST30-TRI-B-LT (Black)	Ø400 x 52 (H) mm

ST30 available in White (**W**) and Black (**B**) trim colour.

- 1** Isolate the mains power supply prior to commencing installation.

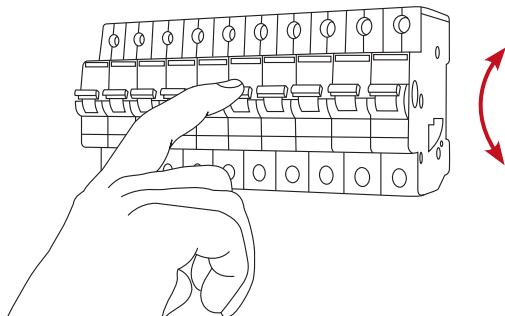

- 2** Remove grub screws to release mounting bracket from luminaire.

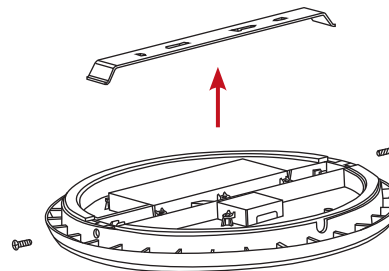

- 3** Fix mounting bracket to the ceiling. Install with a minimum 2 fixings.

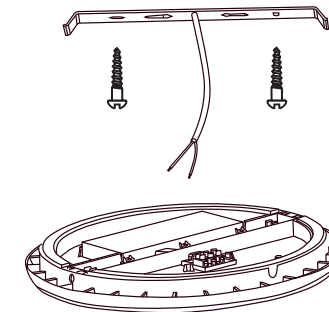

- 4** Only adjust CCT switch (located at rear of luminaire) when luminaire is powered off. CCT switch illustration is shown below.

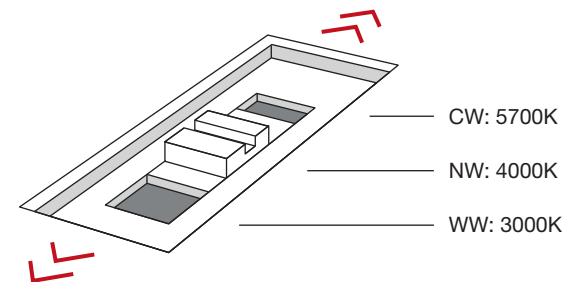

- 4.1** Remove rubber grommet to access CCT Switch.

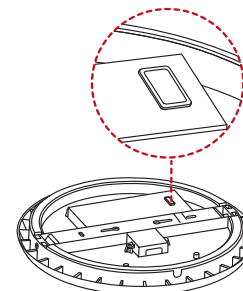

- 4.2** Choose and set desired colour temperature in the CCT switch. Re-insert rubber grommet back into previous location.

