

ITEM NO.:GILSON WB40

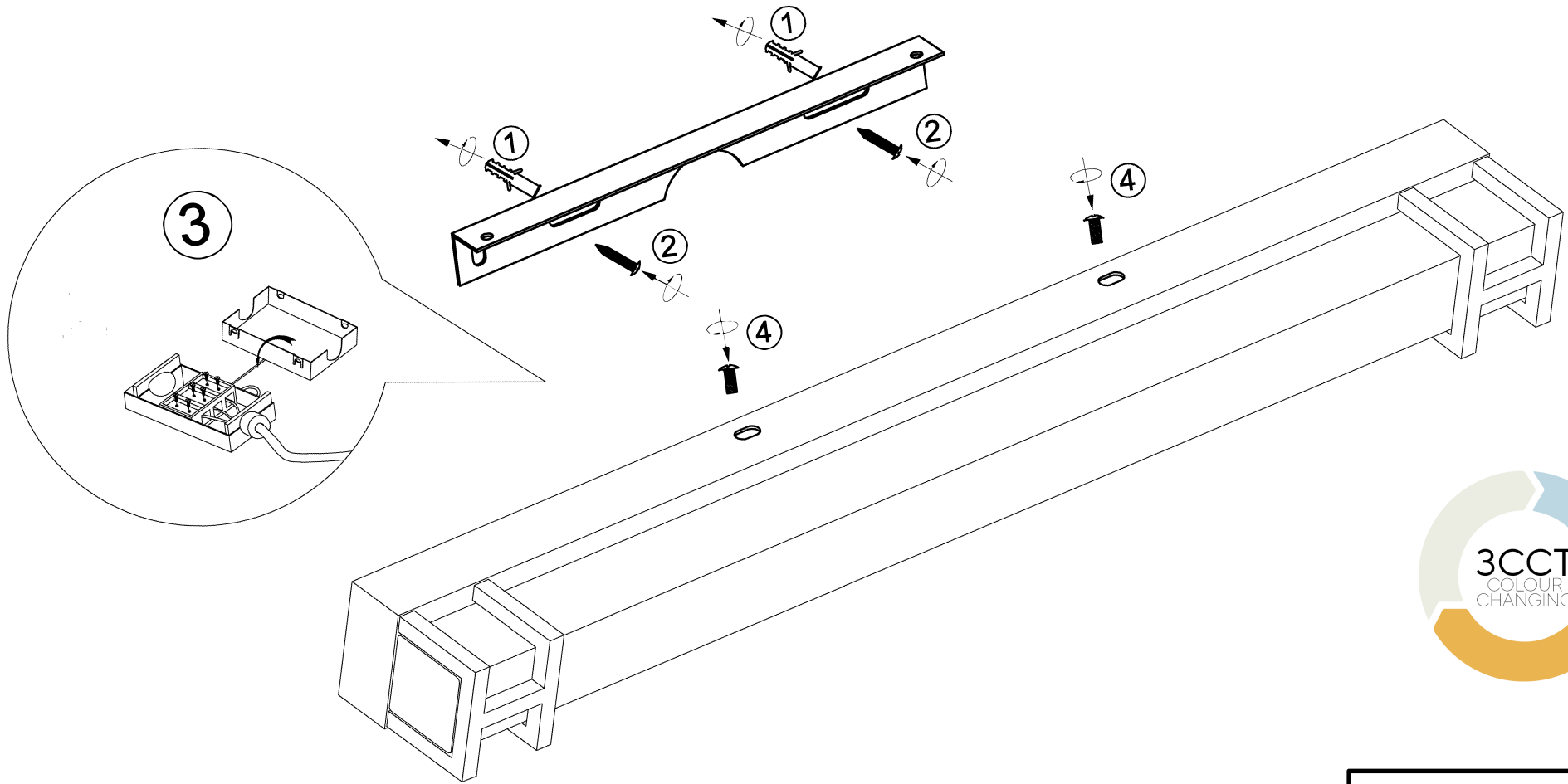

240V ~ 50Hz LED 8W 3000K-4000K-5000K

IMPORTANT
Must be installed by a qualified electrical contractor.
Install in accordance with AS/NSZ3000



Telbix.