



## SLDBL0026-2.6W-PIR



13x SMD LEDs  
@ 0.2W ea



3x 800mAh  
NiMH Batteries



0.6W Built-In  
Solar Panel



Dust & Water  
Protection



Stainless Steel  
Construction

## SLDBL0027-2.6W-PIR



13x SMD LEDs  
@ 0.2W ea



3x 1500mAh  
NiMH Batteries



0.6W Built-In  
Solar Panel



Dust & Water  
Protection



Stainless Steel  
Construction

**BOLLARD LIGHTS WITH MOTION SENSOR**

# Bollard Light with PIR Motion Sensor

## Features:

- Pyro-electric Infrared Sensor
- Built in Photo Electric Cell
- 1 minute Sensor Run Time
- 8-12 hours Operation per day
- Spike Mounted
- Surface Mount Option with Stainless Steel Trim

## SLDBL0026-2.6W-PIR

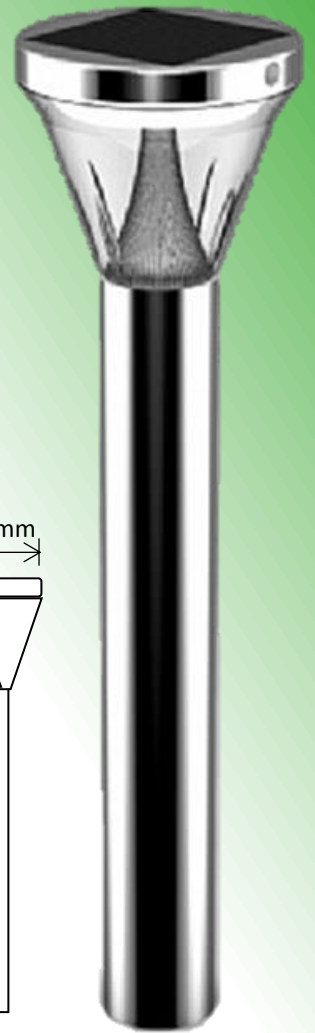
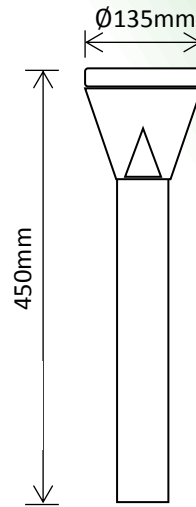
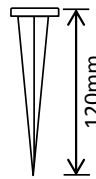
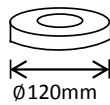
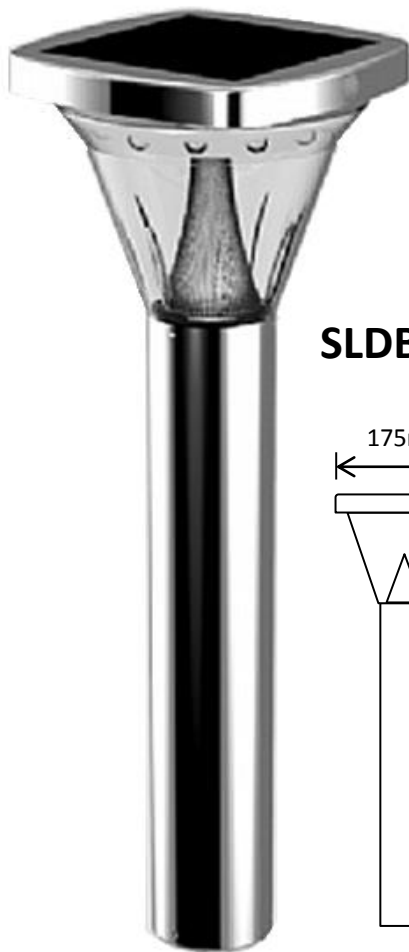

## SLDBL0027-2.6W-PIR

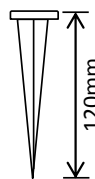
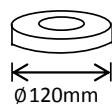
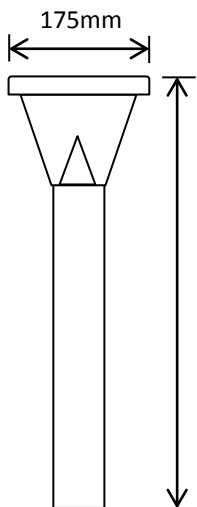

## SLDSSP-100

Optional 1m Post



Refer to pages 80-81 for motion sensor operating specs

