

# Air-e (Ceiling Mounted nanoe™ X Generator)

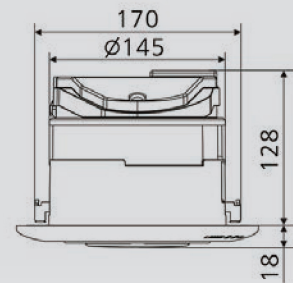

**Dimension**  
Unit: mm

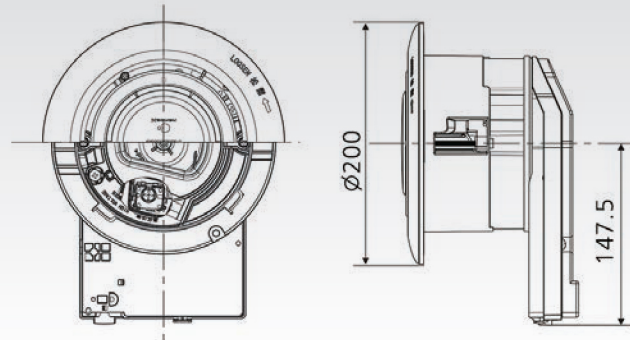

## FV-15CSD1

- nanoe™ X Purification
- Silent Operation
- Low Power Consumption
- Easy Installation
- Contemporary Design
- Compact Size

## Specification

Rated Voltage [V]	Rated Frequency [Hz]	Power Consumption [W]	Air Volume [m3/h]	Noise [dB]	Net Weight [kg]
230	60	4.0	16	25.5	1.1

- The value of air flow rate, power consumption and noise are specified at static pressure 0 Pa.
- The value of air flow rate is the mean value and a tolerance of ±10% is allowed.
- The value of noise level is A weight average sound pressure level, the mean value is measured by our company. A tolerance of +3dB/-7dB is allowed. The noise is measured at 1m apart from the left, the front and the below of the product.
- Condition for generating nanoe™ X
  - Room temperature: about 5°C - 40°C [Dew point temperature more than 2°C]
  - Relative humidity: about 30% - 85%
 nanoe™ X is generated using the air in the room, and its amount is subject to the temperature and humidity.

## DISCLAIMER

- Data provided regarding the effectiveness of nanoe™ X and nanoe™ have been obtained through experiments under special conditions using devices which generate electrostatic atomized water, and have not been tested through commercial products with the devices incorporated in them.
- Deodorization effect varies according to the environment [temperature and humidity], operation time, odor, and fabric types. It does not eliminate toxic substances in cigarettes [carbon monoxide, etc.]. Odors that are continuously generated [e.g. building material odors and pet odors] are not completely eliminated. Results may vary based on usage, and seasonal/environmental variables [temperature and humidity]. nanoe™ X and nanoe™ inhibit activity or growth of viruses, but do not prevent infection.
- Individual results may vary based on usage, and environmental variables [temperature and humidity].

• All information contained in this leaflet is correct at the time of printing, and is subject to change without prior notice.  
 • Images are for illustration purpose only.  
 • Due to printing considerations, the actual color may vary slightly from those shown.

Panasonic Manufacturing Philippines Corporation  
 14th Flr., 6788 Ayala Avenue, 1226 Makati City Philippines  
 Tel: (63) 8886-6291 to 94 | Fax: (63) 8886-6295  
 Email: lifesolutions @ph.panasonic.com

# Panasonic



Improve your Indoor Air Quality



A Better Life, A Better World

In our daily life, we may encounter various indoor air pollutant which are generated from cooking, burning candles or incense, tobacco smoke or external sources that find its way into the house or building. Common residential indoor air pollutants include excessive moisture (humid), virus, bacteria and bad odour. All of these could affect human health and comfort.



### Improve Your Indoor Air Quality

The Air-E (Ceiling Mounted nanoe™ X Generator) can be installed anywhere in homes or public spaces to purify indoor air with Panasonic's unique nanoe™ X technology.

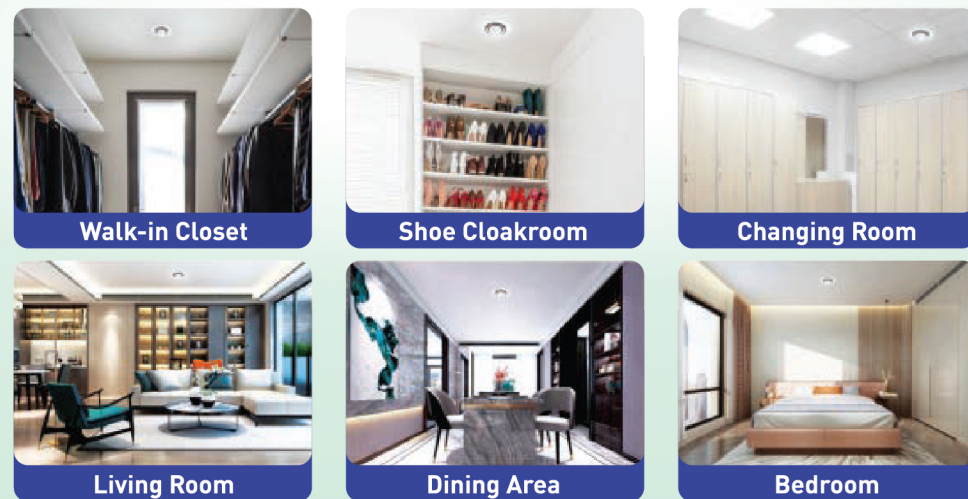

nanoe™ X Technology has been tested and proven to be Anti-Covid-19 virus.\*

# INHIBITS 99.99% OF COVID-19 VIRUS IN 2 HOURS

\*Based on Texcell FRANCE, over 99.99% of the activity of the SARS-CoV-2 virus in a gauze was inhibited in 2 hours inside a 45L box

Scan this to see how nanoe™ X technology ACTs against COVID-19 virus



### Introduction of Panasonic Unique nanoe™ X Technology

nanoe™ X are fine (5 to 20nm) and weak acidic capsules of water containing plentiful Hydroxide (OH\*) radicals that are released into the air. OH radicals inhibit viruses and bacteria (by removing their hydrogen atom), allergens, and deodorize odours that are in the air. The more OH radicals, the more effective bacteria and viruses inhibition rate. A nanoe™ X device releases OH radicals at a rate of 4.8 trillion per second.

**1 nm (nanometer) = 0.00000001 m (one billionth of meter)**

### How nanoe™ X inhibit pollutants?

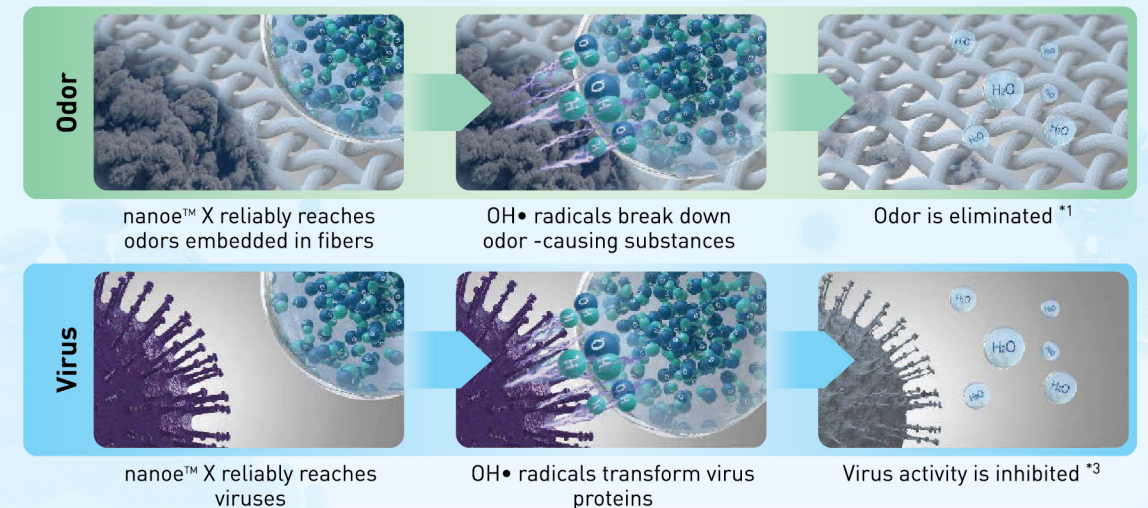

### [Effect]

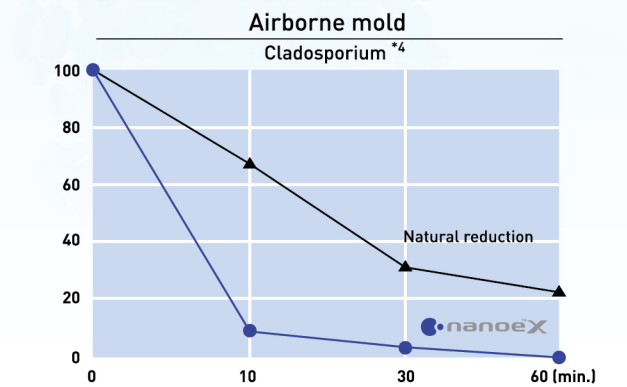
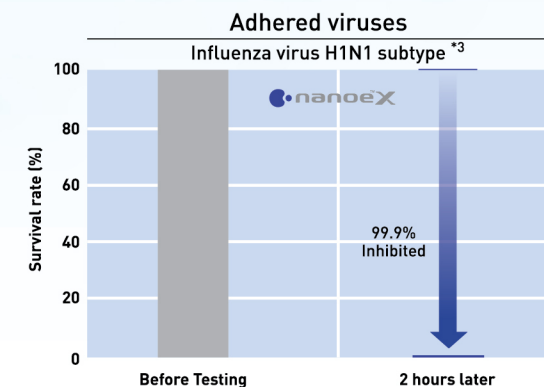
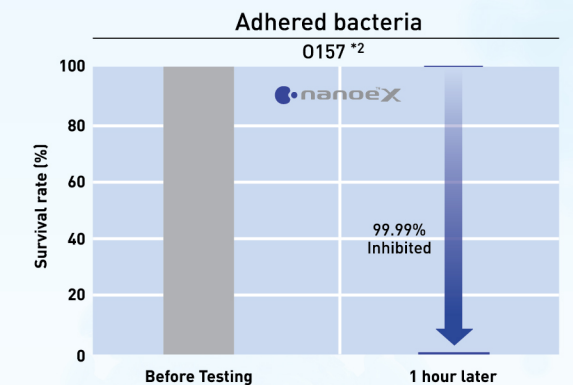
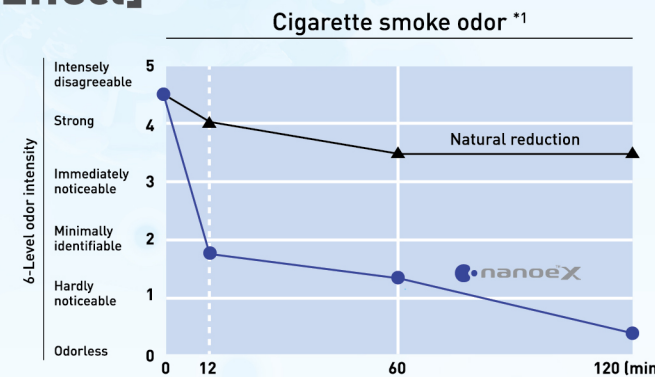

\*1 -Cigarette smoke odor> [Test organization] Panasonic Product Analysis Center [Test method] Verified using the six-level odour intensity scale method in an approximately 23m³ sized test room [Deodorisation method] nanoe™ released [Test substance] Surface-attached cigarette smoke odour [Test result] Odour intensity reduced by 2.4 levels in 12mins (4AA33-160615-N04)  
 \*2 -Adhered bacteria [O157]> [Test organization] Japan Food Research Laboratories [Test method] Measured the number of bacteria adhered to a cloth in an approximately 45L sized airtight test room [Inhibition method] nanoe™ released [Test substance] Adhered bacteria [Test result] Inhibited by at least 99.99% in 1 hour (208120880\_001)  
 \*3 -Adhered virus [Influenza virus H1N1 subtype]> [Test organization] Kitasato Research Center for Environmental Science [Test method] Measured the number of virus adhered to a cloth in an approximately 1m³ sized airtight test room [Inhibition method] nanoe™ released [Test substance] Adhered virus [Test result] Inhibited by at least 99.9% in 2 hours (21\_0084\_1)  
 \*4 -Airborne mold [Cladosporium]> [Test organization] Japan Food Research Laboratories [Test method] Measured the number of mould altered in an approximately 23m³ sized test room [Inhibition method] nanoe™ released [Test substance] Airborne mould [Test result] Inhibited by at least 99% in 1 hour (205061541-001)