

LTECH



Q Series Remotes

Manual  
www.ltech-led.cn

For : Q1/Q2/Q4/Q5

## System Diagram L-BUS

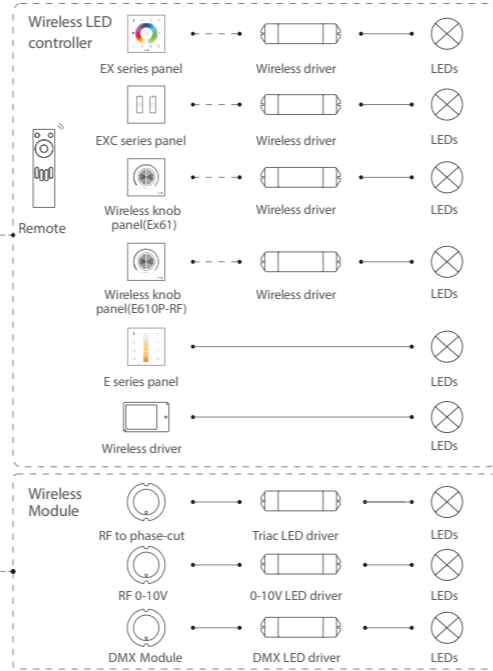
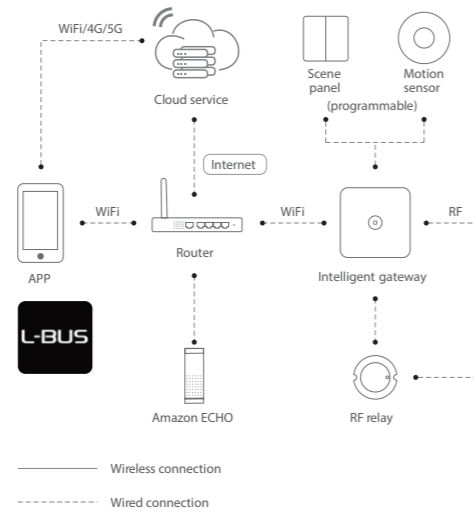

## Product Introduction

Q series remotes are 4-zone remotes with color changing and brightness dimming functions. Color and brightness can be displayed by indicator lights. Within the effective range, Q series remotes are capable of connecting unlimited wireless drivers and keeping the effects in sync. Remotes work with drivers F4-3A, F4-5A, F4-DMX-5A or F5-DMX-4A, also E series touch panels.

## Technical Specs

Remote Type: 4-zone control Working Temp.: -20°C ~ 55°C  
Power Supply: 2 pack AAA battery Package Size: L166xW47xH22(mm)  
Wireless Type: RF 2.4GHz Weight(G.W.): 85g

## Dimensions

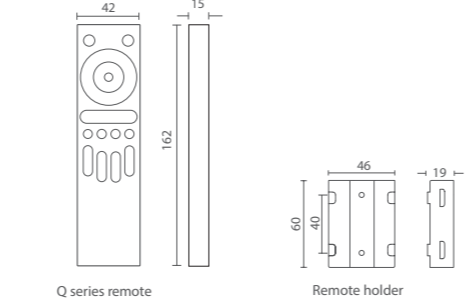

## Key Functions

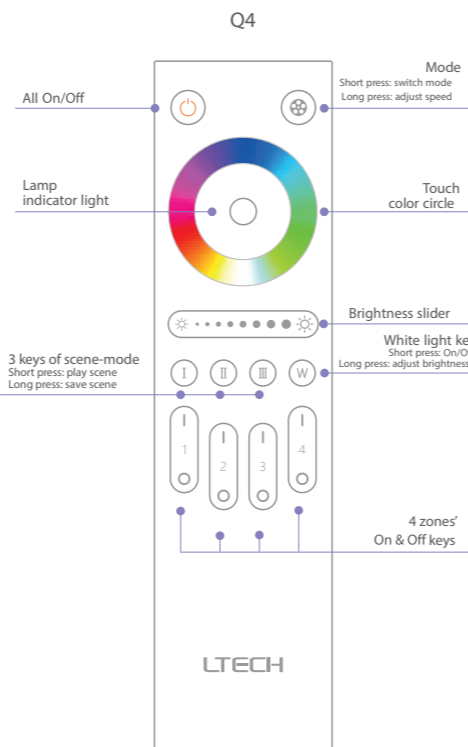
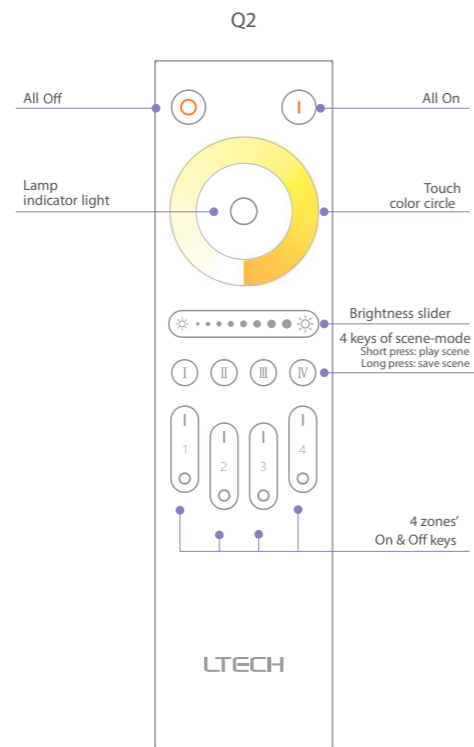
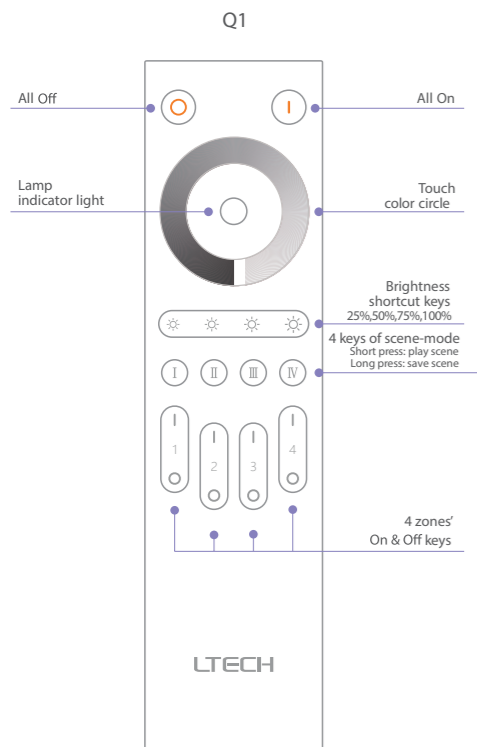

- Mode
- 1. Static red
  - 2. Static green
  - 3. Static blue
  - 4. Static yellow
  - 5. Static purple
  - 6. Static cyan
  - 7. Static white
  - 8. RGB jumping
  - 9. 7 Colors jumping
  - 10. RGB gradient
  - 11. 7 colors gradient
  - 12. Static black (only turn off RGB)

## Key Functions

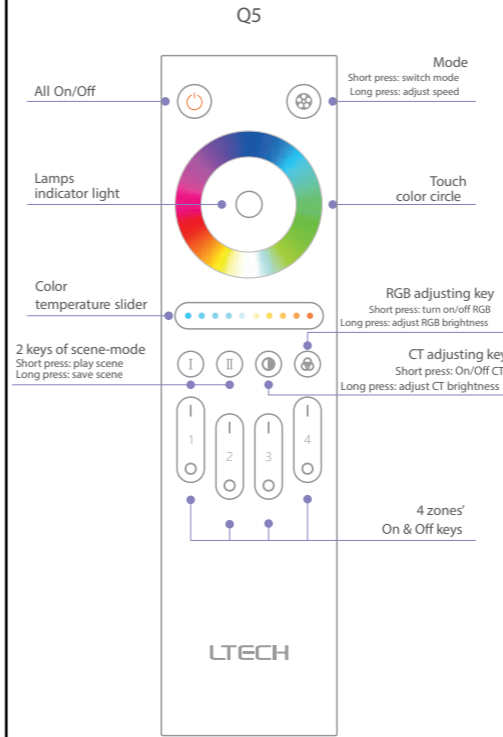

- Mode
- 1. Red-green jumping
  - 2. Green-blue jumping
  - 3. Red-blue jumping
  - 4. RGB jumping
  - 5. 7 Colors jumping
  - 6. Red-green gradient
  - 7. Green blue gradient
  - 8. Red-blue gradient
  - 9. RGB gradient
  - 10. 7 Colors gradient

## Wiring Diagram

Remote works with wireless drivers

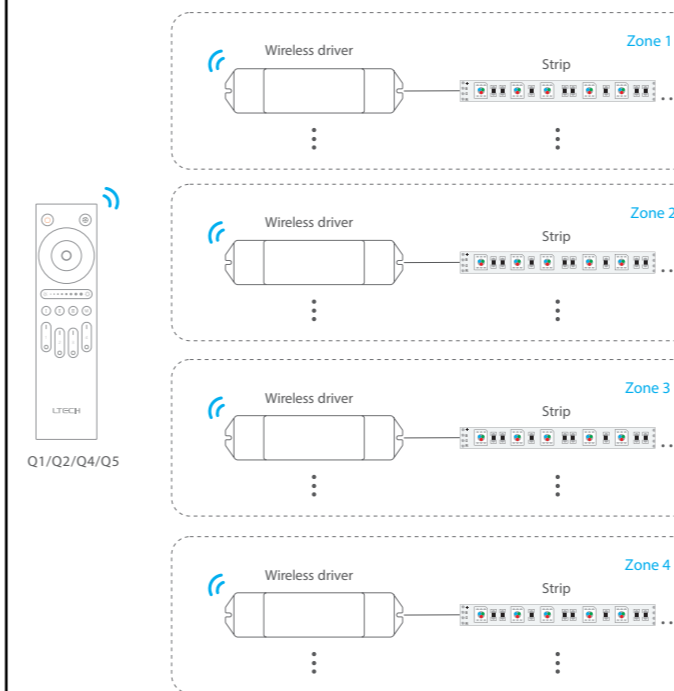

Remote works with E series touch panels

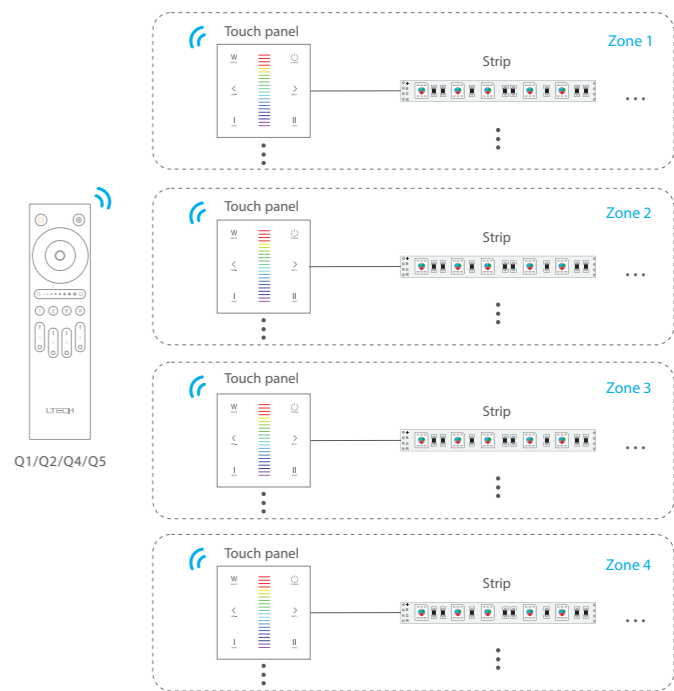

## Match Code

1. Q series remotes work with wireless drivers  
Q1/ Q2/Q4 remote works with F4-3A, F4-5A, F4-DMX-5A wireless drivers.  
Q5 remote works with F5-DMX-4A, EBOX-DMX wireless modules.

Method 1

1.1.1 Power off the wireless driver.



1.1.2 Hold down "ON" key on the remote for the pairing zone, and meanwhile power on the wireless driver.

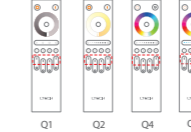

1.1.3 The lamp of wireless driver flashes several times and then stop flashing. You will hear a long beep as confirmation, then pair successfully.

Method 2

1.2.1 Short press "ID learning button" on the wireless driver and the lamp flashes, then please complete the next step within 15s.

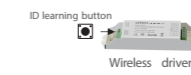

1.2.2 Long press the "ON" key on the remote for the pairing zone.

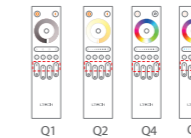

1.2.3 The lamp of wireless driver stops flashing, then pair successfully.

2. Q series remotes work with panels

Q1 remote works with E1/E15/EX1/EX15/EX5 panel;

Q2 remote works with E2/EX2/EX panel;

Q4 remote works with E3/E3S/E4/E4S/EX3/EX3S/EX4/EX4S/EX7/EX7S/EX8/EX8S panel;

Q5 remote works with E5S panel.

2.1 Long press ON on the touch panel until the indicator light flashes.



2.2 Long press the "ON" key on the remote for the pairing zone until the indicator light of the touch panel stops flashing, then pair successfully.



\* Please match/clear code when the touch panel is power-on (the indicator light is white).

3. Match code between remotes (Assuming that B pairs with A)

3.1 Short press the top two keys of remote B simultaneously, release them and the indicator light keeps on.

3.2 Press any key on remote A within 5s. When the indicator light of remote B puts out, pair successfully.

\* Only the same model remotes can pair with each other.

## Clear code

Press the top two keys on remote simultaneously for about 6s. The indicator light flashes twice, then clear code successfully.



www.havit.com.au

\* This manual is subject to changes without further notice. Product functions depend on the goods. Please feel free to contact our official distributors if you have any question.