

01693	EV-LED FIRE
01694	EV-LED FIRE-PRO
01697	EV-LED FIRE-PRO-B
01695	EV-LED FIRE-ULT

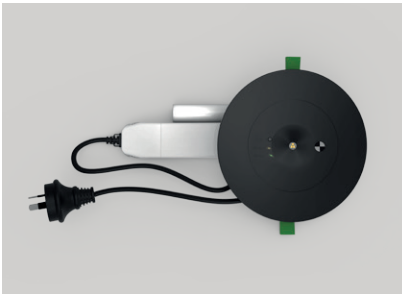

CODE: 01693, 01694, 01695



CODE: 01697

CONTENTS

1. Welcome
2. Overview
3. Safety warnings
4. Installation
5. Maintaining your Ledfire luminaire
6. Replacing the LED dish
7. Replacing the battery
8. Battery life
9. Power and battery charge
10. Wireless daughterboard
11. Self-test wiring / central battery system
12. DALI wiring / central battery system
13. Using the inverter with a switch
14. Using the inverter with a sensor
15. Accessories list
16. Lead and cable accessories
17. Changing/adding the cable set
18. Non maintained / maintained jumper
19. Discharge rating selection
20. Self-test indicator LEDs
21. Self-test / commissioning interval programming
22. Product specifications
23. Australian emergency classification
24. Spacing table
25. Construction sites
26. Testing precautions
27. Problem solving procedure
28. Warranty information
29. Compliance standards
30. Technical support and troubleshooting

I. WELCOME

Thank you for choosing this quality Ektor product. This manual is intended to help you install this product in a way that ensures the safety of yourself and others. Whilst this Ektor product is designed to be installed easily, we highly recommend you take the time to read this manual thoroughly before commencing installation. When installed correctly and serviced regularly, this product will provide hassle free operation for many years.

2. OVERVIEW

Ektor Generation III platform introduces you to a new era of emergency lighting control. With years in the making, the third generation platform builds on the Ektor product ranges' increasing quality, reliability and performance. In choosing this Ektor product you can be comfortable that you have the best.

Out of the box this product can be wired in any of these configurations:

- Self-testing unit
- Standalone unit
- Standalone unit controlled with a switch or sensor
- DALI controlled remote testing unit

And can be used with a central battery system (monitored and non-monitored)

An optional wireless module can be added to allow you to connect to standard Wi-Fi networks for remote testing and reporting.

Our Ektor Generation III platform also brings class leading technology which increases performance and reliability including:

- Smart battery charging technology which reduces power consumption up to 90% while increasing the service life of the battery
- Smart battery conditioning to ensure the best performance from the battery
- 450V Electrolytic capacitors which increase the products reliability
- Highly efficient design to reduce fatigue on the product

For buildings requiring longer durations such as 3, 4 and 8 hours the installer can change the jumpers found on the unit for automatic scaling of the output. Moreover should you require non-maintained or maintained output, the installer can select this on installation.

3. SAFETY WARNINGS

1. **THIS PRODUCT MUST ONLY BE INSTALLED BY A LICENSED ELECTRICIAN.**
2. **BEFORE COMMENCING INSTALLATION TURN OFF AND ISOLATE THE ELECTRICAL SUPPLY.**
3. **DO NOT ENERGISE WITH PRODUCT OPEN OR DISASSEMBLED.**
4. **SUPPLY VOLTAGES WITHIN PRODUCT. ISOLATE SUPPLY VOLTAGES BEFORE OPENING OR SERVICING.**
5. **THE ONLY USER SERVICEABLE PART IS THE BATTERY PACK.**
6. **DO NOT ATTEMPT TO SERVICE OTHER PARTS OF THE FITTING AS THIS WILL VOID THE WARRANTY.**
7. **AS THE INSTALLER, IT IS YOUR RESPONSIBILITY TO ENSURE YOU COMPLY TO ALL RELEVANT BUILDING AND SAFETY CODES FOR EXAMPLE THE BCA, AS3000. REFER TO APPLICATION STANDARDS FOR THE RELEVANT RULES.**
8. **WHEN THE INSTALLATION IS COMPLETE, LEAVE THIS MANUAL WITH THE BUILDING'S OWNER(S) FOR FUTURE REFERENCE.**

4. INSTALLATION

Ektor Ledfire recessed emergency luminaires can be installed in either accessible or inaccessible ceiling cavities. To install the Ledfire please follow the steps listed below:

1. Remove the product from the box and inspect it for any damage. If you believe the product to be damaged or otherwise unsound, **DO NOT** install the product. Please pack it back into its box and return it to the place of purchase for replacement. If the product is satisfactory, proceed with the installation.
2. Choose the dish diameter that is suitable for your application, either 140mm or 84mm. If you are installing the 84mm dish you will have to remove the outer ring first, this is done by twisting it out of its locking position and sliding it down the ring.
3. Drill the hole in the ceiling to suit the dish size you have chosen; 70mm cut out for the 84mm dish or 120mm for the 140mm dish. Note that this product can be installed into an existing cut out in the ceiling ranging from 70mm to 120mm.

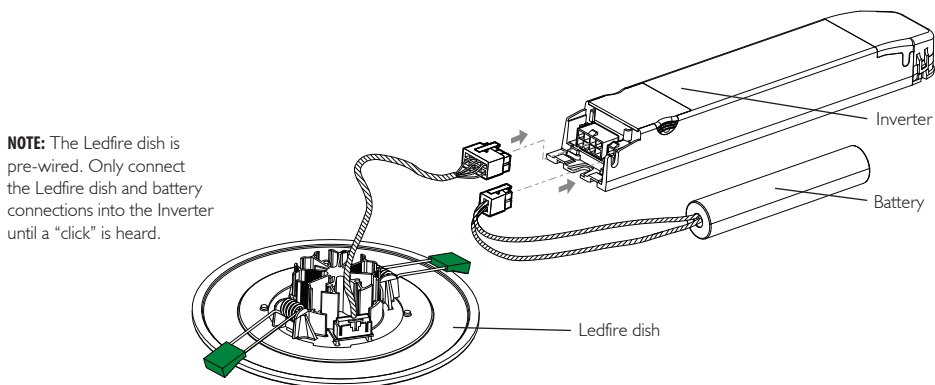
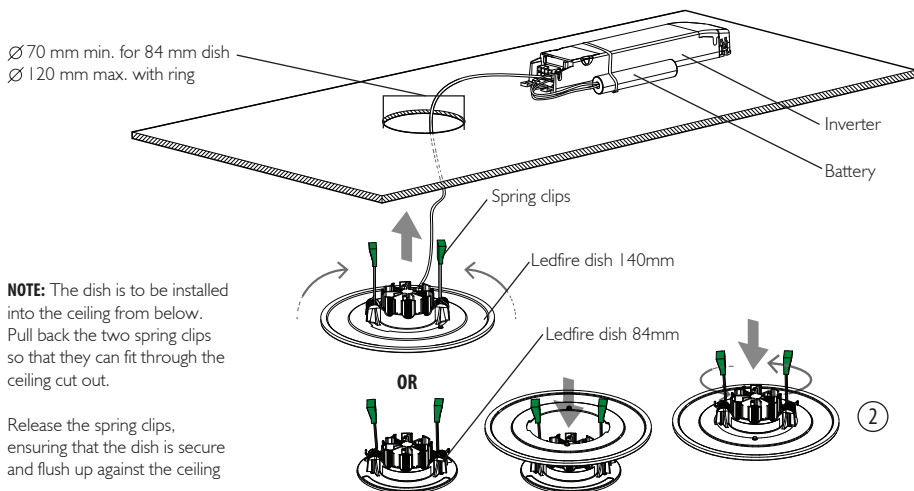

Figure 1: Ledfire assembly and ceiling installation

4. To ensure correct battery performance, it is advised to mount the battery away from any direct heat sources such as air conditioning, heat vents, or ducts. To secure the battery, cable-tie the battery to the inverter in the ceiling cavity.
5. Ensure the inverter/battery charging pack and batteries are mounted in accordance with the standards on the site of installation.
6. Connect the battery pack and dish looms into the relevant sized plug adaptors on the inverter/charging pack unit. These plugs are keyed and can only be installed one way. Ensure the plugs lock-in and are secured.
7. Connect the power to a permanent active power supply and ensure that the units are wired as per the relevant standard requirements.

To check correct operation of the unit allow battery to charge for a few minutes, ensuring green charging LED on the dish is constantly illuminated. When the test switch is pressed the LED light source illuminates.

5. MAINTAINING YOUR LED FIRE LUMINAIRE

WARNING

The Ektor Ledfire Emergency Luminaire is connected to an unswitched active during normal operating conditions. When disconnected from the mains supply, the Ledfire is powered by a LiFePO4 battery operated inverter. Due to this, care should be taken when replacing either the battery or dish.

6. REPLACING THE LED DISH

The LED lamp cannot be replaced if the LED is found to be faulty. The whole LED dish needs to be replaced. When replacing the Ledfire LED dish, please follow the installation instructions shown in **section 4 (page 3)**.

7. REPLACING THE BATTERY

1. Use only the LiFePO4 battery recommended on the label found on the inverter/battery charger pack. No other battery will work in this fitting, other than the type listed.
2. Disconnect the battery from the product and if necessary, cut cable ties to release the battery from its mounting position.
3. Replace the battery as was previously installed and then reinstall inverter/battery pack or install as per all relevant standard requirements.
4. Replace the Ledfire dish back into its previously mounted ceiling position and ensure the green charge light is illuminated. Allow a few minutes for the battery to charge.
5. Allow a minimum 24 hours charging time before carrying out any discharge tests as per the requirements in AS/NZS 2293, BCA or other relevant standards.

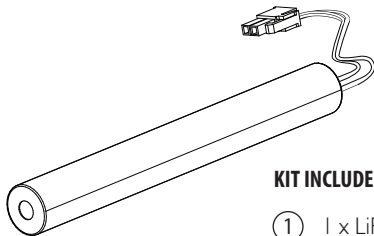
**KIT INCLUDES:**

- ① 1 x LiFePO4 stick battery 01302 / 01303

Figure 2: Example of included battery

8. BATTERY LIFE

To maintain the economic life of this product it is required that the battery be discharged and recharged at least once every 6 months. The battery life can be reduced if the battery is not discharged as per the requirements of AS/NZS 2293 or an equivalent standard. Increasing the number of duration tests above that as defined in AS/NZS 2293 or an equivalent standard can have a positive effect on the battery performance as long as 12 discharge cycles per year is not exceeded.

9. POWER AND BATTERY CHARGE

The Ektor Generation III platform uses smart battery charging technology which reduces power consumption and increases battery life.

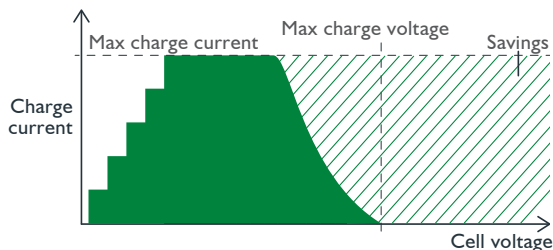

Figure 3: Smart charge rate

During the first stage of operation the battery charger charges the battery until full. Afterwards, the unit goes into a stage which charges the battery periodically. This reduces the battery temperature and reduces the loss of electrolytes which ultimately increases the service life of the battery. As a result of stopping the charging process, the power consumption is reduced and only consumes 1/11th of the typical power.

The smart battery charger also offsets the charger time by a random interval to un-synchronise all the emergency lighting in the building. This reduces the average loading on a building's infrastructure and reduces any impacts of surges created by turning on large numbers of products simultaneously.

10. WIRELESS DAUGHTERBOARD

The Ledfire inverter supports an optional wireless daughterboard. The driver must be disconnected from mains and battery must be removed, before installing or changing any expansion module. More information and a list of other accessories can be found in the **Wireless design and installation guide**. The assembly for this part onto the inverter is shown below:

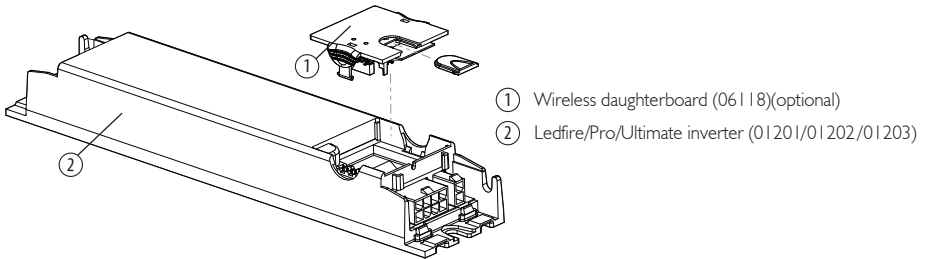

Figure 4: Daughterboard assembly diagram

When installing the inverter with a wireless daughterboard, careful attention needs to be taken to the positioning of the antenna. There is also the option of adding an antenna. The antenna can be mounted in a vertical position, depending on the installation. Care should be taken to mount the antenna away from metal objects or behind large concrete walls. More information and a list of other accessories can be found in the **wireless design and installation guide**.

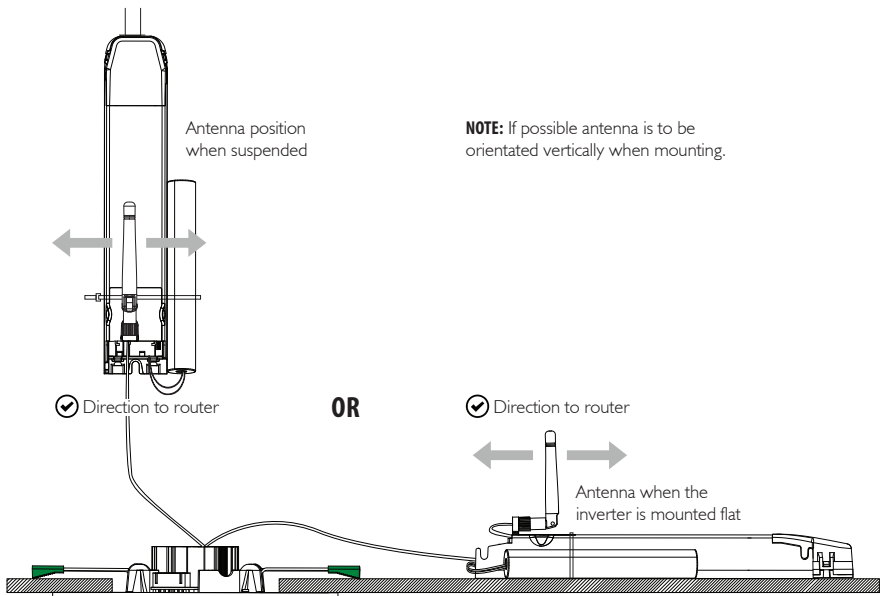

Figure 5: Mounting position of the inverter antenna

11. SELF-TEST WIRING/ CENTRAL BATTERY SYSTEM

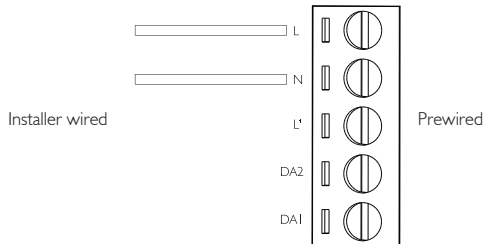

Figure 6: Inverter standard wiring diagram

The inverter can be used in an automatic self-test mode which reduces the need for a test switch timer. The self-test ability automatically disables if the unit is wired to DALI or the wireless daughterboard is attached. Additionally the third generation platform can be wired to a central battery system. With this wiring the system feedback cannot report the light status (refer to the **Configurations: Status LEDs and Device Modes** document.).

12. DALI WIRING/ CENTRAL BATTERY SYSTEM

The Ledfire inverter supports DALI out of the box, a hardwiring diagram is shown below, optionally an installer can order a soft wiring cable set found in section 16. The inverter also supports central battery systems and can be monitored through DALI. When used as a central battery system the devices can be tested with DALI.

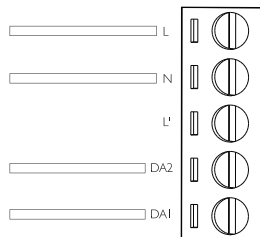

Figure 7: Inverter DALI wiring diagram

13. USING THE INVERTER WITH A SWITCH

A mains rated switch can be wired with this product to turn ON/OFF the non-emergency light in normal use. This does not affect operation in emergency mode.

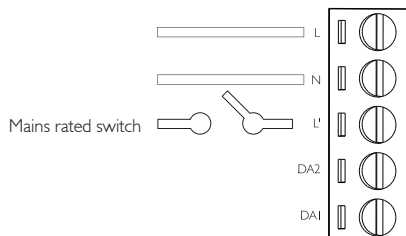

Figure 8: Inverter switch wiring diagram

14. USING THE INVERTER WITH A SENSOR

A mains rated sensor can be wired with this product to turn ON/OFF the light in normal use. This does not affect operation in emergency mode.

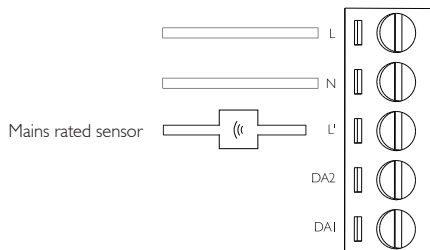

Figure 9: Inverter sensor wiring diagram

15. ACCESSORIES LIST

Below are the listings of the accessories and replacements compatible with the Ledfire.

PART	EVOLT CODE	CODE
COMPLETE UNITS		
Ledfire (White)	EV-LEDFIRE	01693
Ledfire Pro (White)	EV-LEDFIRE-PRO	01694
Ledfire Pro (Black)	EV-LEDFIRE-PRO-B	01697
Ledfire Ultimate (White)	EV-LEDFIRE-ULT	01695
PARTS/REPLACEMENTS		
Ledfire inverter	EV-LEDFIRE-INV	01201
Ledfire Pro inverter	EV-LEDFIRE-PRO-INV	01202
Ledfire Ultimate inverter	EV-LEDFIRE-ULT-INV	01203
Ledfire Dish (White)	EV-LEDFIRE-RD	02101
Ledfire Pro Dish (White)	EV-LEDFIRE-PRO-RD	02102
Ledfire Pro Dish (Black)	EV-LEDFIRE-PRO-B-RD	02104
Ledfire Ultimate Dish (White)	EV-LEDFIRE-ULT-RD	02103
Battery, Stick 1500mAh 6.4V, 2 Cell LiFePO4 to suit Ledfire	EV-1500mAh-6.4V-LiFePO4	01302
Battery 3000mAh 2 Cell LiFePO4 to suit Ledfire Pro & Ult	EV-3000mAh-6.4V-LiFePO4	01303
Ledfire inverter antenna	EV-LEDFIRE-ANT	02111
Ledfire strain relief cover	EV-LEDFIRE-EXTENSION-LOOM	02112
Wireless daughterboard	EV-WIFI-DAUG	06118
Antenna extension	EV-ANTENNA-EXTE	06125
Easy commissioning module - DALI	EV-ECM-DALI	05304
Easy commissioning module - Ektor	EV-ECM-EKTOR	05305

16. LEAD AND CABLE ACCESSORIES

The following cord-sets can be ordered and attached to the inverter depending on the site requirements.

CORD-SET	LENGTH	PRODUCT CODE	DESCRIPTION
A	2.4M	00709	Wire By Click 5-Pin Lead LI 025/5
B	2.4M	00707	Wieland Plug GST18155 BI ZRI S PB02
C	2.4M	00705	CMS 5 Pin Plug Set
D	2.4M	00706	WAGO Plug 5-P Blue WAGO 51110475
E	2.4M	00710	CMS 6 Pin Plug Set
F	1.4M	00708	Flex and Plug (Standard)

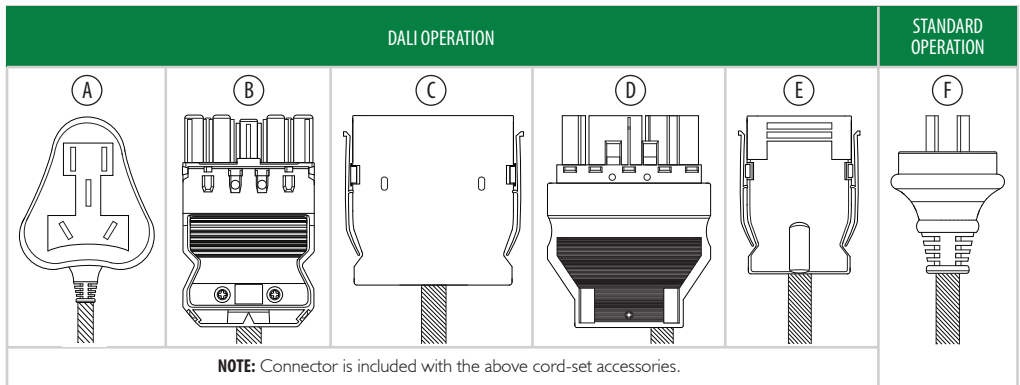
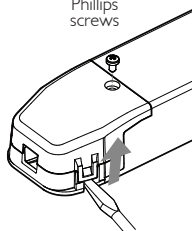

Figure 10: Lead and cable accessories

17. CHANGING/ADDING THE CABLE SET

① Unscrew the safety screw.

② Carefully disassemble cover with flat blade screwdriver.



③ Clip into place to connect the inverter and wiring.

Slide the strain relief down into its slot as shown on the right.

NOTE: If there is already a cable set attached, this must first be removed

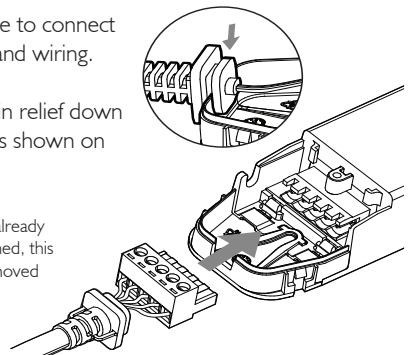



Figure 11: Changing the cable set

18. NON MAINTAINED / MAINTAINED JUMPER

A user can select the mode of operation for the Ledfire inverter. If the inverter is using a switch input this is disregarded and not used.

INDICATOR	STATUS	DESCRIPTION
NON MAINTAINED		LED is only ON in emergency
MAINTAINED MODE		LED is ON in normal and emergency operation

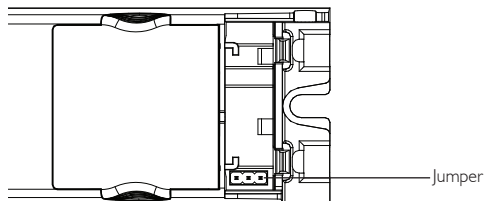

Figure 12: Maintained/non-maintained jumper

19. DISCHARGE RATING SELECTION

The inverter supports a number of discharge ratings which can be selected by the user. The output from the LED scales based on the discharge rating (see section 23 for output classification information).

HOURS	A	B	C
1 Hour	OFF	OFF	OFF
2 Hours (default)	ON	ON	ON
3 Hours	ON	ON	OFF
4 Hours	ON	OFF	ON
8 Hours	ON	OFF	OFF
Central battery operation	OFF	ON	OFF
N/A	OFF	ON	ON
N/A	OFF	OFF	ON

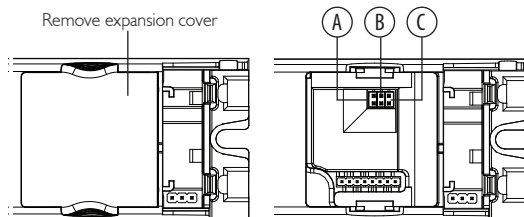





Figure 13: Discharge rating selection

20. SELF-TEST INDICATOR LEDS

The table below shows the operation of the Ledfire status indicators:

INDICATOR	DESCRIPTION
 YELLOW 2sec ON / 2sec OFF	Device is performing a duration test
 YELLOW 4sec ON / 1sec OFF	Last duration test passed. The duration was met when last run. Test ran less than five days ago
 YELLOW 0.5sec ON / 0.5sec OFF	Last duration test failed. Failed to meet duration. The device is not currently running a new test. Mains is on
 GREEN 1xFlash	A duration test is pending. The device is not in any self test and is set to normal mode

21. SELF TEST/ COMMISSIONING INTERVAL PROGRAMMING

The self test mode must first be enabled to perform tests by switching the breaker, or test button in the correct sequence. The test interval is fixed and set to 26 weeks / 182 days. The LEDs indicate the status of the device and which functions are being performed. For more information refer to the **Configurations: Status LEDs and Device Modes** document.

When self test mode is enabled the status LED will flash either 4x (switched active detected) or 3x (switched active not detected) for 2 minutes.

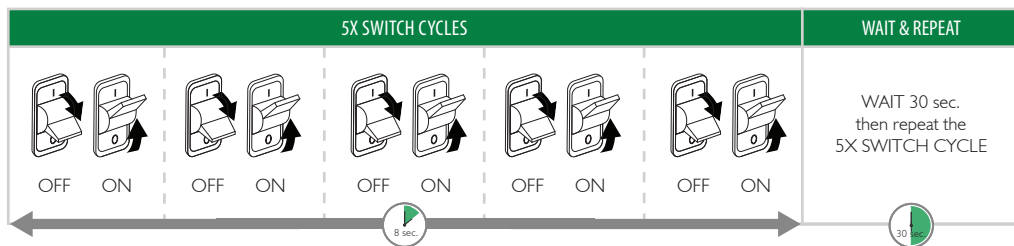

The self test can also be enabled using the test button sequence below:

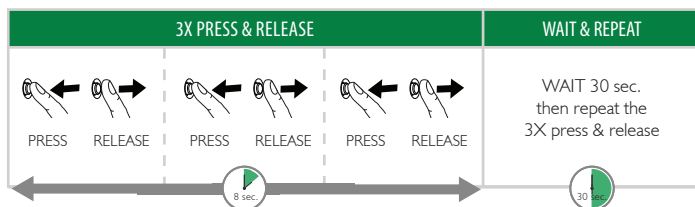

NOTE: If the wait in-between breaker or test button push sequences is longer than **50 seconds** then it will timeout and the procedure will need to begin again.

22. PRODUCT SPECIFICATIONS

LED FIRE DISH

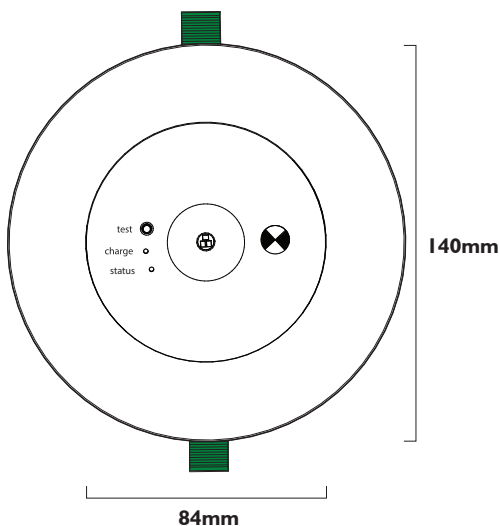

LED FIRE DISH (02101)

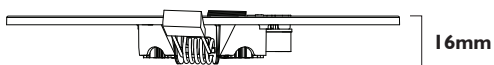

LED FIRE PRO DISH (02102 & 02104)

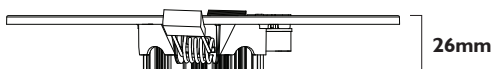

LED FIRE ULTIMATE DISH (02103)

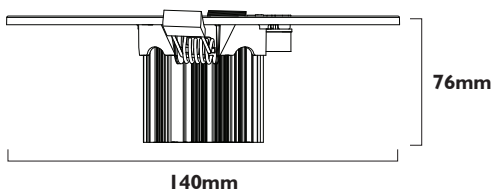

LED FIRE / INVERTER

LED fire inverter with wireless daughterboard and antenna attached.

LED FIRE INVERTER (01201) LED FIRE PRO INVERTER (01202) AND LED FIRE ULTIMATE INVERTER (01203)

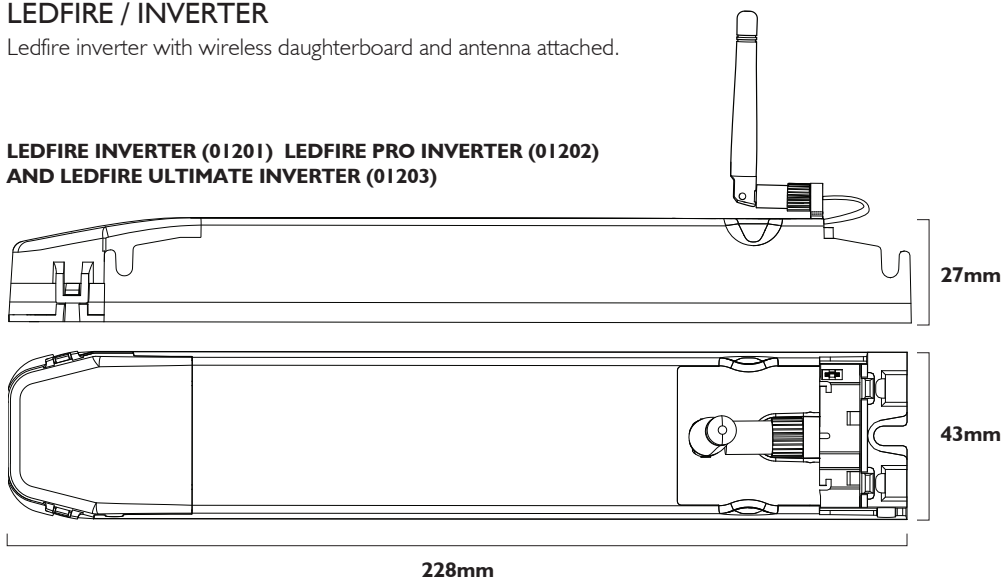

Ledfire inverter without wireless daughterboard or antenna attached.

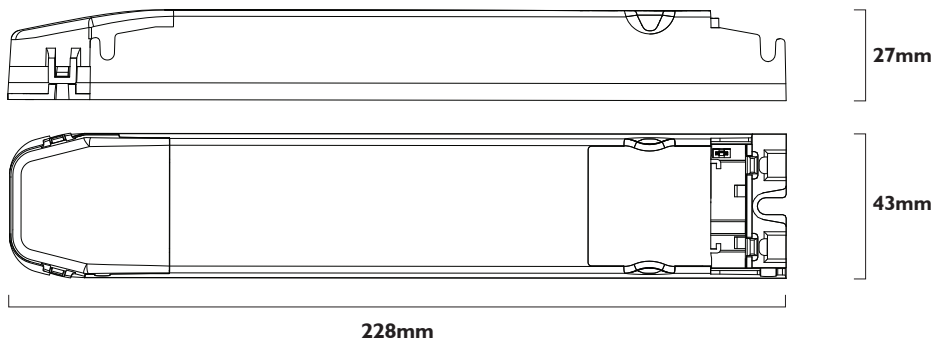

Voltage	220~240V	Viewing distance	N/A
Frequency	50/60 Hz	Mounting type	Recessed
Ambient temp.	0 - 40°C	Wiring	Flex & plug
Battery type	LiFePO4		
Class	2	Battery voltage	6.4V
Duration	Dependant on jumper	Charging time	16 hours
IP Rating	IP20	Charger operation	Adjustable
Storage temperature	0 - 50°C	Charger type	Smart charge

LED FIRE

Maximum power <3W (battery charge only)

LED FIRE PRO & PRO B

Maximum power <7W

LED FIRE ULTIMATE

Maximum power <10W

NOTE: Power ratings stated are the maximum power drawn whilst in maintained mode operation and charging a battery. For power ratings in other configurations and operating modes please refer to the Ektor website.

23. AUSTRALIAN EMERGENCY CLASSIFICATION

Classification of the Ledfire and Ledfire Pro output when duration is selected.

HOURS	LEDFIRE	LEDFIRE PRO	LEDFIRE ULTIMATE
1	D50	D63	D80
2	D50	D63	D80
3	D20	D40	D50
4	D16	D32	D40
8	N/A	D20	D20

24. SPACING TABLE

Below is the spacing table extract from AS/NZS 2293 which details spacing between emergency fittings at different mounting heights.

LUMINAIRE CLASSIFICATION	MOUNTING HEIGHT (M)															
	2.1	2.4	2.7	3	3.3	3.6	4	4.5	5	6	7	8	9	10	15	20
D16	12.1	12.6	13.0	13.3	13.6	13.9	14.1	14.6	14.6	14.4	13.8	12.9	11.5			
D20	13.1	13.6	14.1	14.5	14.8	15.1	15.5	15.8	16.1	16.4	16.3	16.0	15.4	14.5		
D32	15.4	16.1	16.7	17.2	17.6	18.0	18.5	19.1	19.5	20.2	20.6	20.7	20.6	20.3	14.6	
D40	16.7	17.4	18.0	18.6	19.1	19.6	20.1	20.8	21.3	22.1	22.7	23.0	23.1	23.1	19.4	
D50	18.0	18.7	19.4	20.1	20.7	21.2	21.8	22.5	23.2	24.2	24.9	25.4	25.7	25.9	23.7	15.2
D63	19.4	20.3	21.1	21.8	22.4	23.0	23.7	24.5	25.2	26.4	27.4	28.1	28.6	28.9	28.0	22.5
D80	21.1	22.0	22.8	23.6	24.3	25.0	25.8	26.7	27.5	28.9	30.0	30.9	31.6	32.1	32.4	28.9

25. CONSTRUCTION SITES

IMPORTANT NOTE: Continuously switching the power supply to the fitting on and off during or after the installation process due to other processes being conducted on the building site could cause the fitting to discharge and charge its battery many times during a short period which can impact negatively on the battery life. It is not recommended that you connect the Ektor emergency products to the power supply if such conditions are prevalent. If you choose to expose the Ektor emergency products to such harsh operating conditions, Evolt may not honour any warranty on the life of the batteries or the dish. This Ektor emergency product is designed to undergo regular discharge tests but it is recommended that the intervals between consecutive tests are not less than two weeks. Frequent testing of the exit product will reduce the service life of the battery. In order to prevent damage to the battery, leave the unswitched active circuit turned off at the circuit breaker until such time as emergency lighting is required

26. TESTING PRECAUTIONS

When the Ektor emergency product is permanently connected to the mains supply you will need to allow 24 hours to charge its battery. Once the battery is fully charged you will need to conduct a manual discharge test as per the requirements of AS/NZS 2293 or other relevant standards. At the time of printing, the Australian standard requires that new fittings operate in emergency mode for at least 2 hours for their first discharge test. Further tests are to be carried out at intervals of not more than six months. It is important that you keep records of the initial test and ongoing tests in the building's emergency service logbook. If the fitting is not to be permanently connected to the mains supply at the time of installation, you must give it the mandatory 2 hour test when you connect it permanently to the mains supply.

27. PROBLEM SOLVING PROCEDURE

If you have installed and connected the Ledfire as per the instructions contained within this manual and the product fails to work properly, please use the following table as a guide to fixing the problem before calling our office.

FAULT	
Green LED is not lit	<ul style="list-style-type: none"> • AC Supply is not connected • AC Supply turned off • Battery plug not connected to battery pack
Green LED is lit but the lamp does not light when the test switch is pressed	<ul style="list-style-type: none"> • Lamp is damaged • Lamp is not inserted properly • Battery pack is damaged
Lamp lights, but only temporarily, when test switch is pressed or when the main power supply is turned off	<ul style="list-style-type: none"> • Battery pack not fully charged • Battery pack is damaged

28. WARRANTY INFORMATION

Ektor products are distributed in Australia and New Zealand by Evolt Pty Ltd (Evolt).

The Australian Consumer Law as well as other Australian laws guarantee certain conditions, warranties and undertakings, and give you other legal rights, in relation to the quality and fitness for purpose of Ektor products sold in Australia.

In Australia, our goods come with guarantees that cannot be excluded under the Australian Consumer Law. You are entitled to a replacement or refund for a major failure and compensation for any other reasonably foreseeable loss or damage. You are also entitled to have the goods repaired or replaced if the goods fail to be of acceptable quality and the failure does not amount to a major failure. What constitutes a major failure is set out in the Australian Consumer Law.

Nothing in this Warranty purports to modify or exclude the conditions, warranties and undertakings, and other legal rights, under the Australian Competition and Consumer Act and other Australian laws.

Ektor products are warranted in Australia for a period of 12 months from the date of delivery of the product, provided that the products are properly stored, installed, used and maintained in accordance with the instructions contained within their manual.

Products that have been altered in any way or used other than in accordance with their instructions are not covered by this Warranty.

This Warranty is not transferable and is valid only in the hands of the purchaser of the product. The warranty does not cover Ektor products other than those purchased from Evolt. Proof of purchase must be provided to Evolt with any warranty claim. Evolt recommends that the purchaser attaches their proof of purchase to their product manual.

If you wish to claim under this Warranty, you must, at your own expense, return the product or that part of the product which you believe is defective, and proof of original purchase, your name, address and telephone number and a certificate of installation or other document required by the law for the installation of electrical products in the place in which the product was installed, to Evolt Pty Ltd at PO Box 271 Kingsgrove NSW 1480 within 12 months from the date of purchase. Please note that the Warranty does not cover removal or reinstallation of the product or that part of the product which you believe is defective.



Evolt's total liability under this Warranty is limited to the cost of repair or replacement of the faulty product. Evolt may satisfy its obligations under this Warranty in full by repair or replacement of a faulty product.

This Warranty does not apply to consumable items such as lamps or batteries or other items that can be classified as consumable.

For the avoidance of any doubt, any and all warranties or conditions which are not guaranteed under the Australian Competition and Consumer Act or the Australian Competition and Consumer Regulations 2010 and which are not expressly included in this Warranty as additional warranties or conditions are excluded.

This Warranty does not cover loss or damage caused by wear and tear, misuse, incorrect installation or operation, failure to clean and maintain, incorrect voltage or non-authorized electrical connections, adverse external conditions (such as power surges and dips, acts of God, exposure to heat, corrosion, insect or vermin infestation), use of non-authorized or defective parts or globes, or to items that have been repaired other than by Evolt or a repairer approved by Evolt.

29. COMPLIANCE STANDARDS

	STANDARD	TITLE
Australian/ New Zealand Standards 	AS/NZS 2293-3:2005+A1:2010	Emergency escape lighting and exit signs for buildings. Part 3: Emergency escape luminaires and exit signs.
	AS/NZS 60598-2-22:2005	Luminaires Part 2.22: Particular requirements - Luminaires for emergency lighting (IEC 60598-2-22, Ed. 3.1(2002) MOD).
	AS 61000.3.2:2007 + A1:2009	Electromagnetic compatibility (EMC) - Limits - Limits for harmonic current emissions (equipment input current (16 A per phase) (IEC 61000-3-2, Ed.3.0 (2005) MOD).
	AS/NZS CISPR 15:2011	Limits and methods of measurement of radio disturbance characteristics of electrical lighting and similar equipment.
European Committee for Standardisation 	EN 60598-1:2008+A11:2009	Luminaires - Part 1: General requirements and tests.
	EN 60598-2-22:1998+A1:2003+A2:2008	Luminaires - Part 2-22: Particular requirements - Luminaires for emergency lighting.
	EN 55015:2006+A1:2007+A2:2009	Limits and methods of measurement of radio disturbance characteristics of electrical lighting and similar equipment.
	EN 61547:2009	Equipment for general lighting purposes - Electromagnetic compatibility (EMC) immunity requirements.
	EN 61000-3-2:2006+A1:2009+A2:2009	Electromagnetic compatibility (EMC) Limits. Limits for harmonic current emissions (equipment input current \leq 16 A per phase).
	EN 61000-3-3: 2008	Electromagnetic compatibility (EMC) - Part 3-3: Limits - Limitation of voltage changes, voltage fluctuations and flicker in public low-voltage supply systems, for equipment with rated current \leq 16 A per phase and not subject to conditional connection.

30. TECHNICAL SUPPORT AND TROUBLESHOOTING

For further assistance in using this product, consult your nearest wholesaler or Evolt Pty Ltd. Be aware that illustrations and images used are for illustration purposes only and changes may apply to products after the release of this document.



