



INSTALLATION MANUAL

Congratulations on the purchase of your new quality Brilliant Ceiling Fan. Before first using, it is most important that you read and follow the instructions in this Installation Manual, even if you feel you are quite familiar with this type of product.

Find a place and keep this manual handy for future reference.

Model Name: CANYON DC			
Code	Colour	Size	Light
20896/05	Matt White	56" (1420mm)	N/A
20896/06	Matt Black	56" (1420mm)	N/A
20896/51	Matt Black / Oak	56" (1420mm)	N/A



IMPORTANT SAFEGUARDS

Read all instructions carefully, even if you feel you are quite familiar with this type of appliance.

When using electrical appliances, in order to reduce the risk of fire, electric shock, and/or injury, these basic safety precautions should always be followed:

1. This ceiling fan **MUST** be installed by a Qualified Electrical Contractor in accordance with the local regulations, and all local, state and national electrical codes. Any alterations or additions to building wiring must be completed by a licensed electrical mechanic, or person authorised by legislation to work on the fixed wiring of any electrical installation.
2. The ceiling fan must be connected to a 240V AC 50Hz power supply.
3. All electrical work must only be undertaken after disconnection of the power by removing fuses or turning off the circuit breaker, to ensure all pole isolation of the electrical supply.
4. The fan must be electrically Earthed.
5. The fan must be installed that the blades are **at least 2.1 metres** above the floor.
6. The structure that the ceiling fan is connected to must be capable of supporting a weight of at least 45kg. The fixing must be able to support the moving weight of the fan and must not twist or work loose.
7. Make sure that the installation site will not allow the rotating fan blades to come into contact with any object and that there is a minimum clearance of 150mm (6") from the blade tip to the wall or ceiling. Please note that the bigger this clearance is the better the airflow from your fan will be.
8. **DO NOT** use outdoors unless covered. Refer to Warranty terms for Alfresco use.
9. **DO NOT** connect the fan motor to a dimmer switch. This may damage to the motor. Use **ONLY** the provided wall controller.
10. This appliance is not intended for use by persons (including children) with reduced physical, sensory or mental capabilities, or lack of experience and knowledge, unless they have been given supervision or instruction concerning use of the appliance by a person responsible for their safety.
11. Young children should be supervised to ensure that they **DO NOT** play with the appliance.
12. It is not recommended that ceiling fans and gas appliances be operated in the same room at the same time.
13. The fan must be turned off and stopped completely before reversing the fan direction. This will prevent any damage to the motor of the fan or controller (if installed).
14. Do not insert anything into the fan blades whilst they are spinning. This will damage the blades and upset the balance of the fan causing the unit to wobble.
15. After the fan is completely installed make sure that all base and fan blade fixings are secured and tightened to prevent any problems.
16. Because of the fan's natural movement, some connections may loosen. Check the support connections, brackets and blade attachments twice a year to make sure they remain secured. If any are loose, tighten.
17. A blade balancing kit is included. Ensure blades are balanced immediately after installation to reduce wobble and noise.
18. An all-pole disconnection incorporated in the fixed wiring is to be provided, such as an all-pole switch or a supply cord fitted with a plug.

IMPORTANT NOTE:

The important safeguards and instructions given in this manual are not meant to cover all possible conditions and situations that may occur. It must be understood that common sense, caution and care are factors which cannot be built into any product. The persons caring for and using the unit must supply these factors.

SUGGESTED TOOLS NEEDED

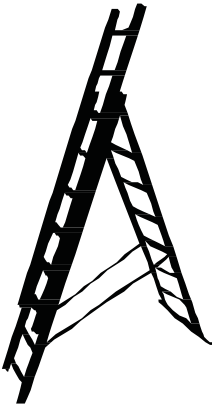

LADDER

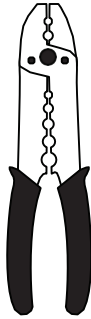

WIRE STRIPPERS



SNUB NOSE
PLIERS

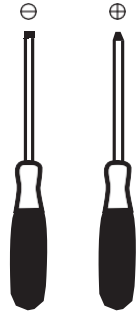

SCREWDRIVERS



WARNING

1. To avoid fire or electric shock, follow all wiring instructions carefully.
2. Turning off wall switch is not sufficient. To avoid possible electrical shock, be sure electricity is turn off at the main fuse box before wiring.
3. Do not install or use fan if any part is damaged or missing.
4. This product is only designed to use only those parts supplied with this product and/or any accessories designated specifically for use with this product by Brilliant Lighting. Substitutions of parts or accessories not designated for use with this product by Brilliant Lighting could result in personal injury or property damage.



**MUST BE
INSTALLED
BY A LICENSED
ELECTRICIAN**

CONTENTS

UNPACKING

- Preparation
- Choosing A Suitable Location

INSTALLATION

- Mounting The Hanging Bracket
- Electrical Connections
- Blade Attachment
- Attach Downrod
- Attach Yoke Cover
- Hanging The Fan
- Attach Receiver and Canopy
- Balancing

REMOTE CONTROL

- Settings for Multiple Fans
- Operations

MAINTENANCE

- Care & Cleaning
- Noise
- Wobble
- Normal Wear & Tear
- Ripple Control Filter

TROUBLESHOOTING

- Technical Data
- Accessories
- Spare Parts

WARRANTY

UNPACKING

PREPARATION:

- Unpack your ceiling fan carefully, and dispose of the packaging materials thoughtfully. Place all parts and components, on a cloth or soft surface to avoid damage. DO NOT lay the motor housing on its side, the housing may get damaged.
- Before commencing installation, check that all parts are included. NB: You may need to remove all foam packaging material to ensure there are no missing components.

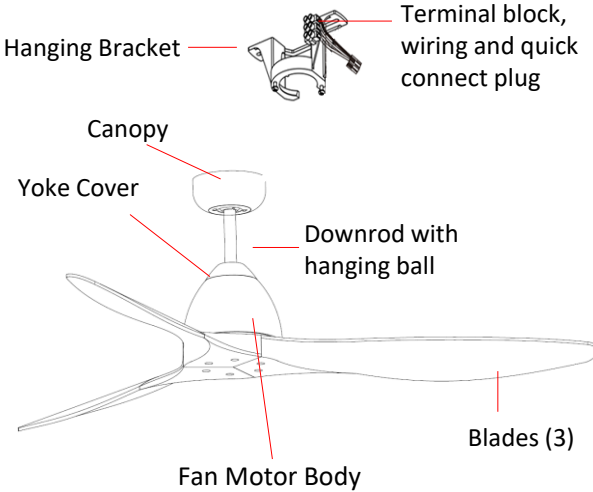

Hardware Bag

For Mounting Plate:

Flat Washer	x2		
Wood Screw	x2		

For Blade Balance :

Balancing Slide x 1		
Weight block (3G x 2)		

Remote Controller Set

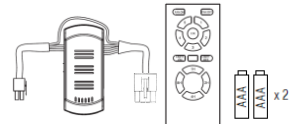

For Blade Assembly:

Blade Screw x 7 (one for spare)		
------------------------------------	--	--

CHOOSING A SUITABLE LOCATION:

- Ceiling fans should be installed in the middle of the room, with a safe distance of at least 2.1m from floor, and 150mm from wall.
- An extension rod may be required for rake ceiling installation.

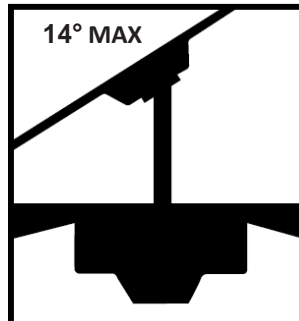
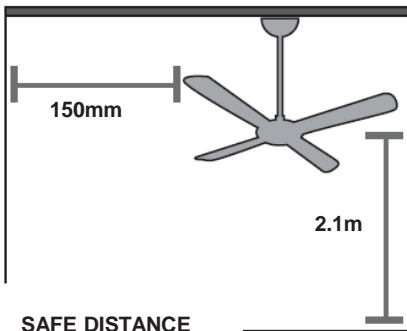

INSTALLATION

CAUTION: Before installing the fan, make sure you have turned OFF the electricity supply.

MOUNTING THE HANGING BRACKET

1. Secure the hanging bracket to the ceiling joist or suitable structure that is capable of carrying a load of at least 45kg, with the two long fixing screws provided. Ensure that at least 30mm of the screw is threaded into the support.

NB: The fixing screws included are designed for use when ceiling fan is secured onto timber joists. For all other surfaces, additional and suitable fixing screws for that surface will need to be purchased.

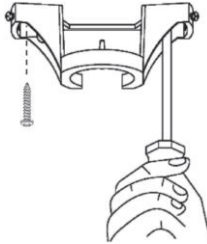

NOTE: Ensure building cable will enter the canopy close to terminal block .

2. Make sure that the position of installation will not allow the blades to come into contact with any object. The fan must be mounted so that the tips of the blades are **at least** 2.1 metres above the floor.

ELECTRICAL CONNECTIONS

The building cable should enter the canopy about 10-15mm from the terminal block.

Connect the mains supply cable to the terminal block on the hanging bracket as per marking on it. Ensure connections are firm. For your convenience, and to assist in easy installation, your ceiling fan is connected with Brilliant's easy connect system. Simply slot the receiver into the hanging bracket, then connect the male and female connectors, and ensure all excess wiring is retained inside the ceiling canopy.

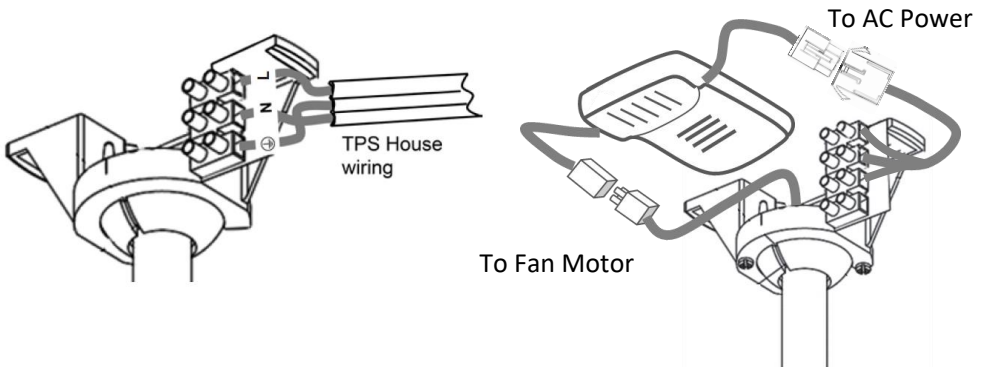

BLADE ATTACHMENT:

1. Align the blade with the blade mounting holes in motor housing and secure firmly, using the screws provided.
2. Tighten all blades screws evenly and securely to ensure quiet, wobble free operation of the fan. Do not over-tighten
3. Repeat for all three blades.

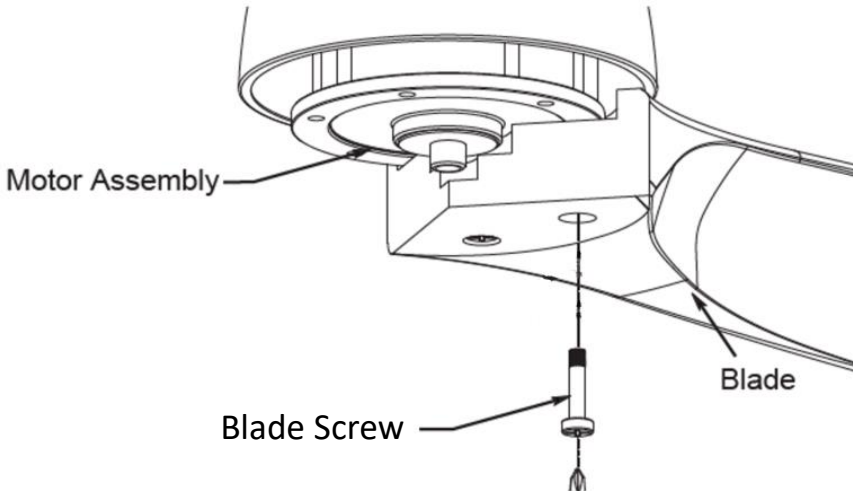

ATTACH DOWNROD

1. Loosen downrod ball by loosening the screw. Slide downrod ball and remove the pin.

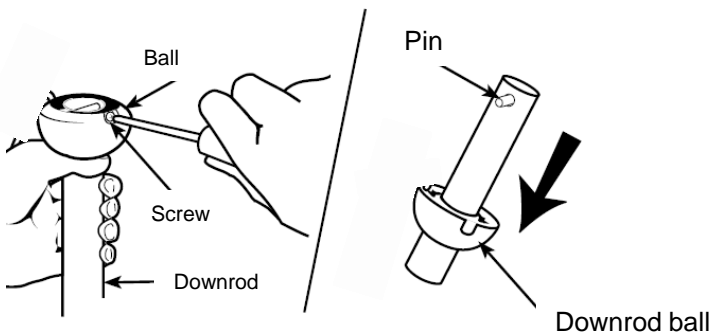

ATTACH YOKE COVER

1. Route the motor wires through the yoke cover, and downrod.
2. Align the clevis pin holes in the downrod with the holes in the motor coupling.
3. Install the clevis pin and secure with the hairpin clip. The clevis pin must go through the holes in the motor coupling and the holes in the downrod.
4. Tighten the set screws to make sure the downrod is secured.

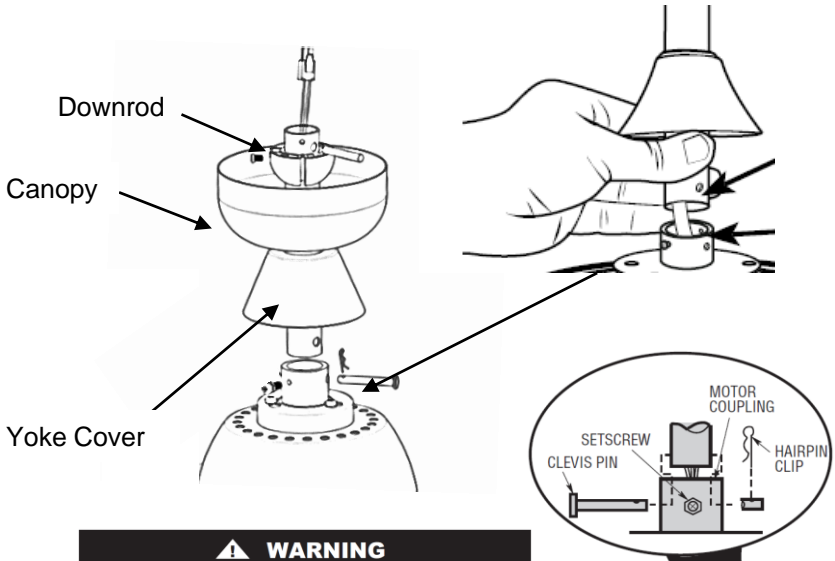

⚠ WARNING

It is critical that the clevis pin in the motor coupling is properly installed and the setscrews securely tightened. Failure to verify that the pin and setscrews are properly installed could result in the fan falling.

HANGING THE FAN

1. Carefully lift the fan, and place the down rod ball assembly into the hanging bracket ensuring that the ball correctly locks into place.
2. Rotate the fan assembly so that the groove on the ball aligns with the ridge on the mounting bracket.

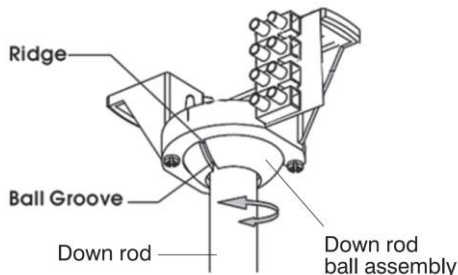

ATTACH RECEIVER

For your convenience, and to assist in easy installation & cleaning, your ceiling fan is connected with Brilliant's easy connect system. Simply connect the male and female couplings, and then ensure remote control receiver and all excess wiring is retained inside the ceiling canopy. Please also read remote controller instruction manual before installation.

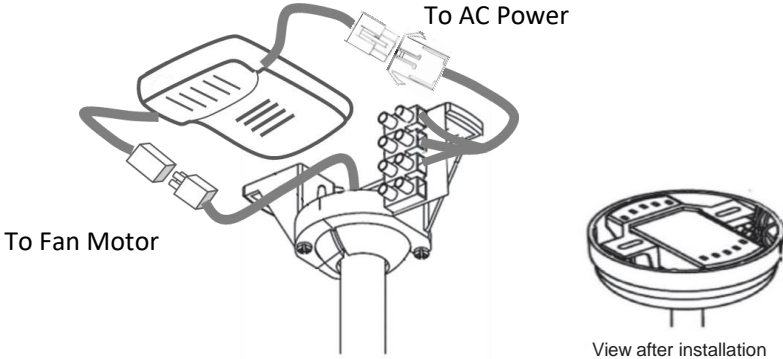

ATTACH CANOPY

Carefully slide the canopy up to cover the hanging bracket and ball joint, taking care not to damage wires. Once in position, secure the canopy with the screws provided.

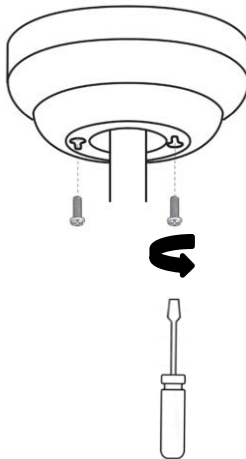

BALANCING

This fan includes a blade balancing kit. Upon initial installation, the balance kit should be used on the fan blades to reduce wobble.

The balance kit includes instructions on how to perform the balancing procedure.

Balancing the fan and reducing wobble will result in quieter operation and optimum performance.

REMOTE CONTROL

SETTINGS

After the installation is complete, install the AAA batteries (included) into the remote control. The fan is ready to be use.

Note: Your fan and remote has been factory pre-set and are ready to be operated immediately. If the fan needs to be re-programmed. Follow these instructions below.

- 1) Turn the power OFF and wait for at least 10 seconds.
- 2) Turn the power ON, and at the same time press and hold the button "FAN ON" for 3-5 seconds till the receiver beeps.
- 3) Setup is complete.

SETTINGS FOR MULTIPLE FANS

If another fan is required in the house and is to be controlled by a separate remote, then perform the following functions:

- 1) Turn the power OFF to all fans and wait for at least 10 seconds.
- 2) Turn the power ON to **ONLY** the fan that needs to be re-programmed, and at the same time press and hold the button "FAN ON" for 3-5 seconds till the receiver beeps.
- 3) Setup is complete.

OPERATIONS

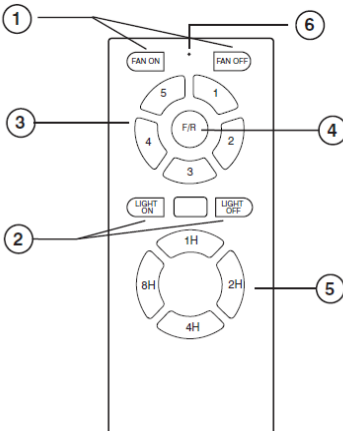

- ① ON/OFF - Fan Operation
- ② ON/OFF - Light Operation
- ③ Fan Speed (1-Low Speed → 5-High Speed)
- ④ Direction of the fan (reverse switch)
- ⑤ Fan control timer (1hr/2hr/4hrs/8hrs)
- ⑥ LED indicator light

MAINTENANCE

CARE & CLEANING

- Periodic cleaning of your ceiling fan is the only maintenance required.
- Use a soft brush or lint free cloth to avoid scratching the finish. Please turn off electricity when you do so.
- Do not use water when cleaning your ceiling fan. It could damage the motor or the wood blades and create the possibility of an electrical shock.
- Do not use abrasive cleaning agents as they may damage the finish.
- The motor has a permanently lubricated ball bearing, and as such is maintenance free.

NOISE

The manufacturer warranty covers actual faults that may develop, but NOT minor complaints, e.g. hearing slight noise from motor in operation - ALL ELECTRIC MOTORS ARE AUDIBLE TO SOME EXTENT, more so, when the fan is operating at low speeds.

WOBBLE

- Ceiling fans are mounted very securely on steel brackets with rubber cushioning or with ball joints to allow free movement.
- Ceiling fans are designed to move during operation because they are not generally rigidly mounted - if they were, they could generate excessive ceiling vibration and stress on their mountings.
- Movement of a couple of centimetres is quite OK and does not suggest the fan will fall down.
- Please note that all ceiling fans are not the same, even in the same model - some may move more or less than others.

NORMAL WEAR AND TEAR:

Threaded components working slightly loose or blade carriers even slightly bent due to vigorous cleaning or bumping can cause extra wobble and noise. **THIS IS NOT COVERED UNDER WARRANTY** but a little care and maintenance can reduce or prevent this problem.

RIPPLE CONTROL FILTER:

In parts of Australia (NSW and QLD), the power company superimposes a signal voltage onto the mains household voltage. This signal voltage is used to remotely control consumer's electric hot water heaters and other devices throughout the surrounding area.

Unfortunately this signal can appear at the ceiling fan as a loud intermittent "hum". If this noise is apparent please contact your local Electricity service provider on how they can assist to provide rectification, usually in the form of a mains supply ripple filter to filter out this signal.

TROUBLESHOOTING

TROUBLE	PROBABLE CAUSE	SUGGESTED REMEDY
Fan/Light will not start	A Fuse or circuit breaker has blown.	A Check main and branch circuit breakers
	B Loose wire connections to the fan.	B Check line wire connections to the fan.
	C Battery flat in remote control.	C Replace 2xAAA batteries in remote control
Fan wobbles	A Fan blades are not horizontal to the ceiling.	A Re-tighten all screws on blades. Do not make any adjustments by applying pressure up or down on blades.
	B Blade screws are loose.	B Make sure all screws are tightened.
	C Fan blades not balanced.	C Balance fan blades with balance kit.
Fan sounds noisy	A Loose fan blades.	A Retighten all screws on fan.
	B Ceiling fan not secured against ceiling.	B Retighten all screws in the hanging bracket.
Mechanical noise	A Fan has not settled in fully.	A Allow at least 8 hours settling in period.
	B Blades not balance.	B Balance the blades.
	C Hanging bracket or canopy screws are loose.	C Tighten all screws.

TECHNICAL DATA

MODEL NUMBER	SIZE	RATED VOLTAGE	RATED POWER FOR MOTOR	WEIGHT	LIGHT POWER
20896	56 INCH	240VAC	40W DC	4.5kg	N/A

ACCESSORIES	
Colour	Extension rod with Loom Kit
White	100550/05
Black	20252/06, 100550/06

SPARE PARTS			
Blades	Remote Controller Set	LED Array	Diffuser
20896SP052 (matt white), 20896SP062 (matt black), 20896SP512 (oak)	20896SP001	N/A	N/A

WARRANTY

Please note, this warranty voids any other warranties supplied with this product and complies with the new consumer guarantee requirements.

The benefits conferred by this warranty are in addition to all implied warranties, other rights and remedies in respect of the product, which the consumer has under Australian Consumer Law.

The original purchaser of this Brilliant Ceiling Fan is provided with the following warranty subject to the Brilliant Warranty terms and conditions as found on the Brilliant website and the following conditions.

Brilliant Lighting (Aust) Pty Ltd warrants this ceiling fans motor for a period of 6 years from the date of purchase, the first 3 years are covered by an In-home warranty. All parts deemed defective in workmanship or materials will be replaced free of charge. Remote controllers, Wall controllers and Light fittings are subject to Limited warranty status.

PRODUCT	TOTAL WARRANTY PERIOD	IN-HOME SERVICE PERIOD
Ceiling Fan Motor	6 YEARS	3 YEARS
Wall Controller	2 YEARS	2 YEARS
Remote Controller Set	2 YEARS	2 YEARS
Light Fittings	2 YEARS	2 YEARS

**Consumable items such as Batteries and Light Globes will not be covered by this warranty.*

This warranty is in addition to any other rights and remedies of the customer under any law. In applications not intended for household, personal or domestic use, liability is limited to replacement or reimbursement of product only.

The warranted use of fans outdoors are limited to Enclosed Alfresco like areas where conditions are similar to indoor installations.

The warranty conditions for fans installed in Enclosed Alfresco areas are as follows:

- * Fan must be shielded from wind and rain (enclosed area, min. 1.5m from edge of eave/roof).*
- * The warranty will cover open circuit motor faults, and remote control faults if not related to outdoor exposure.*
- * The Warranty will not cover outdoor related issues such as rusting, or failure clearly caused by water, moisture or wind.*
- * The Warranty will not cover external appearance or finish of any part of the ceiling fan.*
- * The Warranty will not cover wooden blades. These are recommended only to be used indoors.*

The warranty does not cover Ripple Control noise/interference (identified by a periodic or intermittent hum). This must be addressed with your energy service provider.

The warranty does not cover noises or faults due to poor installation or failure to balance fans as per instructions.

Our goods come with guarantees that cannot be excluded under the Australian Consumer Law. You are entitled to a replacement or refund for a major failure and compensation for any other reasonably foreseeable loss or damage. You are also entitled to have the goods repaired or replaced if goods fail to be of acceptable quality and the failure does not amount to a major failure.

Any claim under this warranty must be made within the warranty period of the date of purchase of the product. To make a warranty claim please refer to the Warranty Claim Form on the Brilliant Website: www.brilliantlighting.com.au

This warranty is given by:

Brilliant Lighting (Aust) Pty. Ltd.

ABN 37 006 203 694

956 Stud Road Rowville, VIC 3178

Phone: 03 9765 2555

Email: warranty@brilliantlighting.com.au

MADE IN CHINA

