

# atom

## INSTALLATION SHEET LED FLOODLIGHT AT9819/TRI

10W, 30W and 50W Slim floodlight.

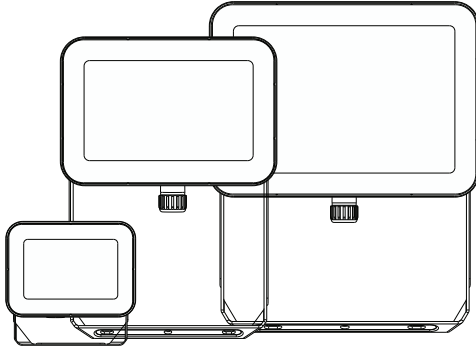

### Product Specification

<b>Voltage</b>	230V~ 50Hz			
<b>Light colour options</b>	Warm white	Cool white	Daylight	
<b>Colour temperature</b>	3000K	4000K	5000K	
<b>Lumen output</b>	<b>10W</b>	960lm	1015lm	970lm
	<b>15W*</b>	1540lm	1640lm	1600lm
	<b>20W*</b>	1960lm	2120lm	2040lm
	<b>30W*</b>	2750lm	3075lm	2870lm
	<b>50W</b>	4670lm	5220lm	4940lm
<b>Colour rendering index</b>	>80			
<b>Dimmable</b>	No			
<b>Warranty</b>	3 Years			
<b>Working temperature</b>	40 °C			
<b>IP Rating</b>	IP65			
<b>IK Rating</b>	IK06 (10W, 30W), IK07 (50W)			
<b>Electrical classification</b>	Class I			

\*Selectable via power switch

### Product range

Code	Wattage	Dimensions (mm)
AT9819/TRI/10	10W	W95 x H70 x D28
AT9819/TRI/30	15W, 20W, 30W*	W160 x H110 x D28
AT9819/TRI/50	50W	W200 x H145 x D28

\*Selectable via power switch

### SAFETY INFORMATION

- Luminaires must be installed and fitted by a qualified electrician ensuring the installation complies to the current wiring regulations.
- The LED's in this downlight CANNOT BE REPLACED.
- Ensure all electrical connections are secure and that there are no loose strands.
- Do not jet wash as the bulkhead is not rated for high pressure jets of water and may be damaged.
- This floodlight is not dimmable.
- Always switch off the mains supply before installation or servicing.
- There are no other serviceable parts in this product.
- Make sure that the fixings are adequate to support the weight of the floodlight and hold it rigidly.
- The supplied mains cable of this luminaire cannot be replaced; if the cord is damaged, DO NOT dismantle the fitting or attempt to repair.

### Installation

Read instructions and check you have all the tools and accessories to complete the installation correctly. Unpack the luminaire and check that you have all the tools to install the floodlight safely and in compliance with current electrical standards. Ensure there are no obstructions or services in the way.

1. Isolate the mains power supply before commencing installation of the floodlight.
2. Position the floodlight in your desired position. A. Mark out the fixing points using the floodlight handle and a pen/pencil. B. Drill fixing holes according to your chosen fixing method. C. Fix in position. Fixings are not supplied.
3. Unscrew cap at bottom of luminaire to change CCT on switch
4. Unscrew cap at bottom of luminaire to change power on switch (30W model only)
5. If using a sensor, attach at bottom of luminaire and configure using steps in manual provided with sensor
6. Terminate the mains cable to an appropriate IP rated junction box or similar.
7. Restore the mains power supply, switch on and test for correct operation.
8. Adjust the floodlight head towards the area to be illuminated and lock off using the two clamping bolts.

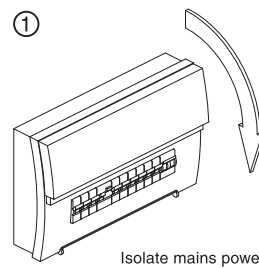

Isolate mains power

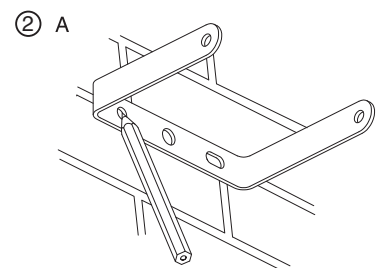

Mark fixing points

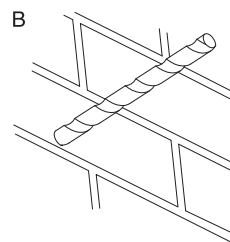

Drill fixing holes according to your chosen fixing method

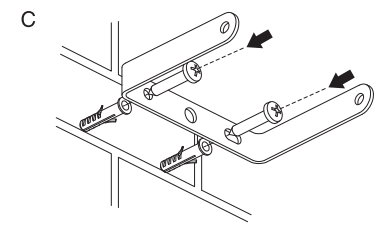

Fix in position. Fixings not supplied

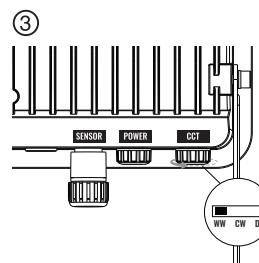

Adjust CCT on switch

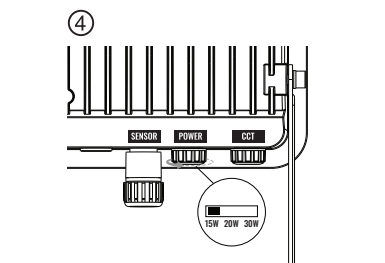

Adjust power on switch (30W model only)

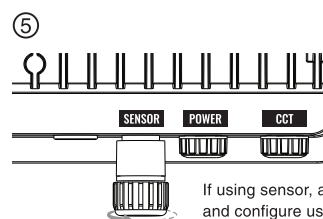

If using sensor, attach and configure using steps in separate manual. (30W and 50W models only)

This product may contain substances that can be hazardous to the environment if not disposed of properly. Electrical and electronic equipment should never be disposed of with general household waste but must be separated of its correct treatment and recovery. Where possible recycle your packaging. Please keep these instructions safe for future reference.

⑥

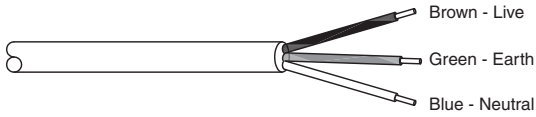

Terminate the mains cable to an appropriate IP rated junction box or similar

⑦

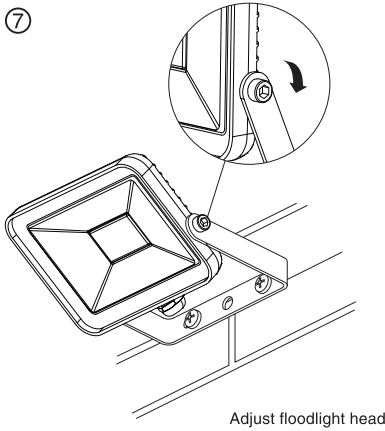

⑧

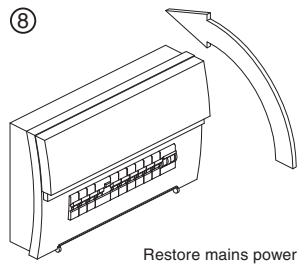

## Warranty

Atom products are distributed in Australia by Atom Pty Ltd (Atom). The Australian Consumer Law as well as other Australian laws guarantee certain conditions, warranties and undertakings, and give you other legal rights, in relation to the quality and fitness for purpose of Atom products sold in Australia.

In Australia, our goods come with guarantees that cannot be excluded under the Australian Consumer Law. You are entitled to a replacement or refund for a major failure and compensation for any other reasonably foreseeable loss or damage. You are also entitled to have the goods repaired or replaced if the goods fail to be of acceptable quality and the failure does not amount to a major failure. What constitutes a major failure is set out in the Australian Consumer Law.

Nothing in this Warranty purports to modify or exclude the conditions, warranties and undertakings, and other legal rights, under the Australian Competition and Consumer Act and other Australian laws. Atom products are warranted in Australia for a period specified on packaging from the date of delivery of the product, provided that the products are properly stored, installed, used and maintained in accordance with the instructions contained within their manual.

Products that have been altered in any way or used other than in accordance with their instructions are not covered by this Warranty.

This Warranty is not transferable and is valid only in the hands of the purchaser of the product. The warranty does not cover Atom products other than those purchased from Atom. Proof of purchase must be provided to Atom with any warranty claim. Atom recommends that the purchaser attaches their proof of purchase to their product manual.

If you wish to claim under this Warranty, you must, at your own expense, return the product or that part of the product which you believe is defective, and proof of original purchase, your name, address and telephone number and a certificate installation or other document required by the law for the installation of electrical products in the place in which the product was installed, to Atom at the address above within the warranty period from the date of purchase.

Please note that the Warranty does not cover removal or re-installation of the product or that part of the product which you believe is defective.

Atom's total liability under this Warranty is limited to the cost of repair or replacement of the faulty product. Atom may satisfy its obligations under this Warranty in full by repair or replacement of a faulty product. This Warranty does not apply to consumable items such as lamps or batteries or other items that can be classified as consumable.

For the avoidance of any doubt, any and all warranties or conditions which are not guaranteed under the Australian Competition and Consumer Act or the Australian Competition and Consumer Regulations 2010 and which are not expressly included in this Warranty as additional warranties or conditions are excluded.

This Warranty does not cover loss or damage caused by wear and tear, misuse, incorrect installation or operation, failure to clean and maintain, incorrect voltage or non-authorized electrical connections, adverse external conditions (such as power surges and dips, acts of God, exposure to heat, corrosion, insect or vermin infestation), use of non-authorized or defective parts or globes, or to items that have been repaired other than by Atom or a repairer approved by Atom.

Atom is a registered brand of Evolt Pty Limited.

IMPORTANT: THIS PRODUCT MUST BE INSTALLED BY A LICENSED ELECTRICIAN

Due to changes in industry standards and Evolt's policy of continual product development, product specifications are subject to change without notice. Images are for illustrative purposes only.

For further information please call Evolt's head office on 1300 4EVOLT (438 658).  
Evolt Pty Limited PO BOX 271 KINGSGROVE NSW 1480  
ABN 83 112 123 529  
www.evolt.com.au