

# AQS-500 / Mono

AQS-500 is a high output top-view IP68 Neon Flex. Use for external facade illumination, pool copings, in-pavement channels and exterior wall grazing where substantial moisture and mechanical protection is required.

## Neon Flex

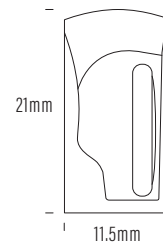
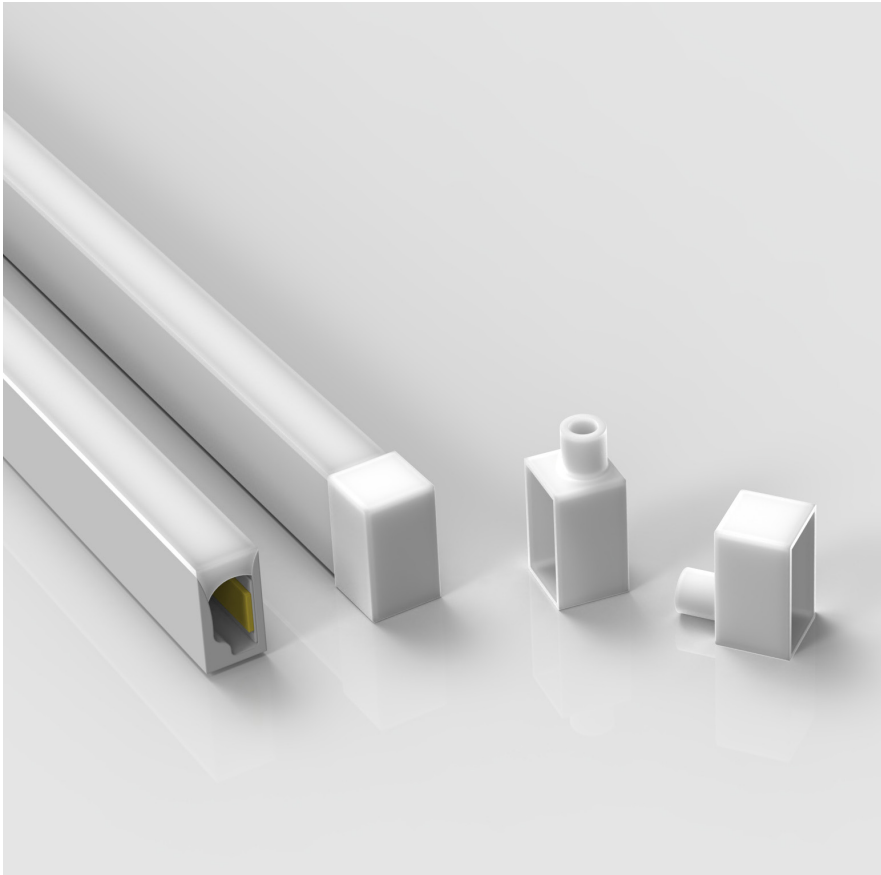

Product	AQS-500-Mono
Voltage	24V DC
Watts (per Meter)	5W / 12W
IP Rating	IP68
Lumen Output (per Meter)	See Page 2
CCT & Colour Options	2200K - 6500K / Colours
Working Mode	Constant Voltage (PWM) / DMX
Max Length (Single Power Feed)	15m (5W) / 10m (12W)
Max Length (Double Power Feed)	30m (5W) / 20m (12W)
Cut Interval	166.7mm (5W) / 100mm (12W)
Bend Direction	Horizontally
Minimum Bend Diameter	80mm
LED Type	SMD3528 (5W) / SMD5050 (12W)
LED Qty / M	72pcs (5W) / 60pcs (12W)
Lumen Maintenance	70,000 Hours L70@ 25°C, 50,000 Hours L70@ 50°C
Materials	Eco PVC
Emission Angle	120°
Operating Temperature	-20° to +40°C
Installation Temperature	5° to +35°C
Warranty	3 Year Aqualux Warranty

### Production Tolerances

The AQS-500 series Neon Flex product is manufactured in a continuous extrusion process and then manually terminated with IP68 overmolded cable entry points. Production tolerances need to be accounted for during site preparation.

- < 1M ±5mm
- < 5M Length ±10mm
- < 10M Length ±15mm
- < 20M ± 20mm

Refer to installation guide when planning your project.

For wiring diagrams please refer to the aqualux website: [www.aqualux.com.au](http://www.aqualux.com.au) / Support / Downloads / Wiring Diagrams

As with all IP68 products, the ingress protection is determined by the quality of the cable joins and installation.

## Neon Flex

### Variations

Product Code	CCT Kelvin	Voltage Direct Current	Watts Meter	Lumens Meter	Max Run Single End	Max Run Double End
AQS-500-GNA12	GREEN	24V DC	12W	253lm	10m	20m
AQS-500-BUA12	BLUE	24V DC	12W	29lm	10m	20m
AQS-500-LYA12	LEMON YELLOW	24V DC	12W	430lm	10m	20m
AQS-500-PKA12	PINK	24V DC	12W	92lm	10m	20m
AQS-500-22A12	2200K	24V DC	12W	280lm	10m	20m
AQS-500-27A12	2700K	24V DC	12W	340lm	10m	20m
AQS-500-30A12	3000K	24V DC	12W	340lm	10m	20m
AQS-500-35A12	3500K	24V DC	12W	340lm	10m	20m
AQS-500-40A12	4000K	24V DC	12W	360lm	10m	20m
AQS-500-45A12	4500K	24V DC	12W	360lm	10m	20m
AQS-500-50A12	5000K	24V DC	12W	370lm	10m	20m
AQS-500-65A12	6500K	24V DC	12W	320lm	10m	20m
AQS-500-GNA05	GREEN	24V DC	05W	119lm	15m	30m
AQS-500-BUA05	BLUE	24V DC	05W	20lm	15m	30m
AQS-500-RDA05	RED	24V DC	05W	45lm	15m	30m
AQS-500-ORA05	ORANGE	24V DC	05W	35lm	15m	30m
AQS-500-AMA05	AMBER	24V DC	05W	37lm	15m	30m
AQS-500-PKA05	PINK	24V DC	05W	53lm	15m	30m
AQS-500-22A05	2200K	24V DC	05W	127lm	15m	30m
AQS-500-27A05	2700K	24V DC	05W	130lm	15m	30m
AQS-500-30A05	3000K	24V DC	05W	130lm	15m	30m
AQS-500-35A05	3500K	24V DC	05W	130lm	15m	30m
AQS-500-40A05	4000K	24V DC	05W	142lm	15m	30m
AQS-500-45A05	4500K	24V DC	05W	145lm	15m	30m
AQS-500-50A05	5000K	24V DC	05W	150lm	15m	30m
AQS-500-65A05	6500K	24V DC	05W	160lm	15m	30m

### Bending Directions

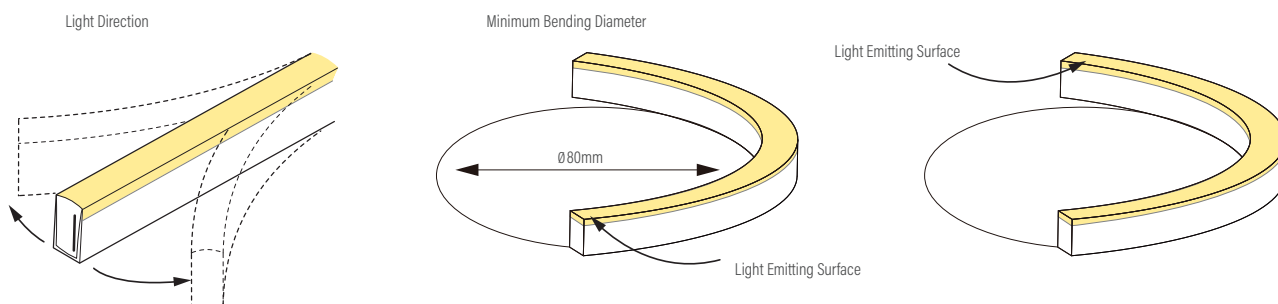

## Anti-Siphon Cable Entry Options

- Integrated non-removeable anti-siphon device
- IP68 factory assembly only
- Injection Moulded Connectors

### Direct Cable Entry

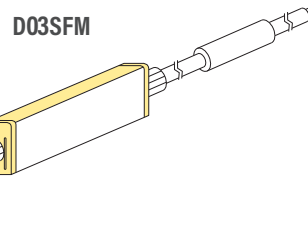
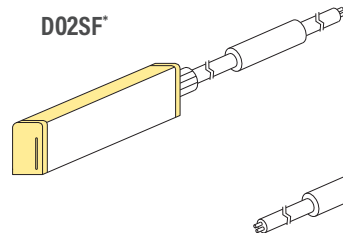
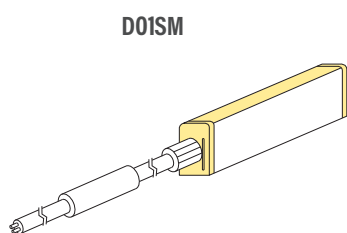

\*For use in DMX / SPI signal flow direction.

### Side Cable Entry

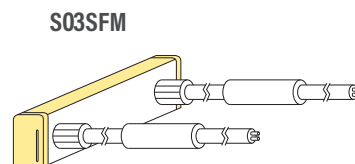
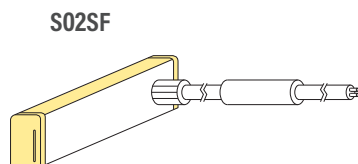
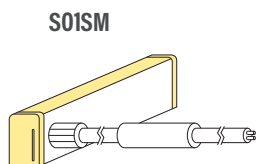

### Bottom Cable Entry

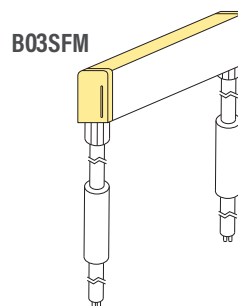
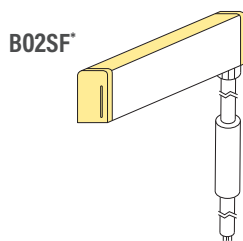
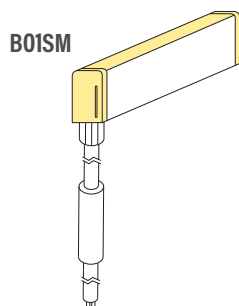

\*For use in DMX / SPI signal flow direction.

# Neon Flex

## Injection Moulded Entry Dimensions

### Direct Cable Entry

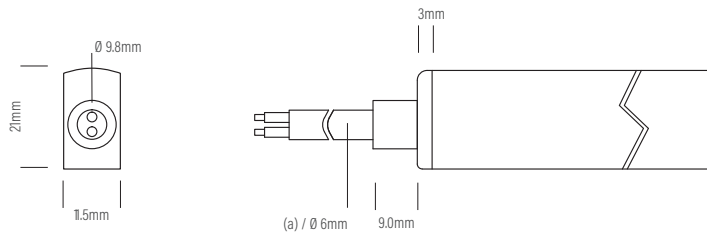

(a) = Minimum length of 6 - 8mm

### Side Cable Entry

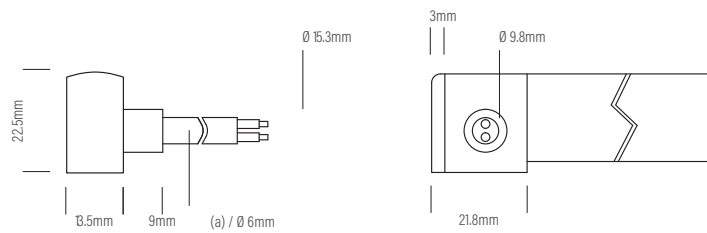

(a) = Minimum length of 6 - 8mm

### Bottom Cable Entry

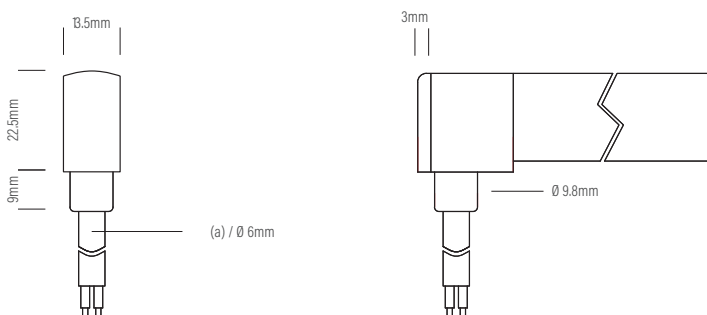

(a) = Minimum length of 6 - 8mm



# Neon Flex

## Mounting

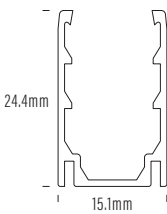

**AQS-500-ACC-AL-01**  
1m Aluminium

**Anti-slip profile.**

1. More aggressive retention of Neon Flex.
2. Harder to remove once inserted.
3. Use for vertical or inverted mounting applications.

**AQS-500-ACC-AL-02**  
2m Aluminium

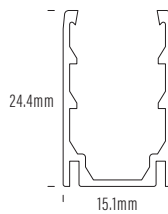
**AQS-500-ACC-AL-04**  
1m Polycarbonate

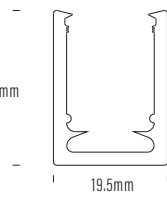
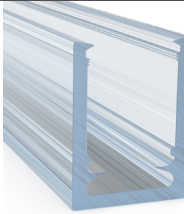

**AQS-500-ACC-AL-01-SS**  
316SS mounting clip

**Application.**

1. Pools and High Corrosive areas.

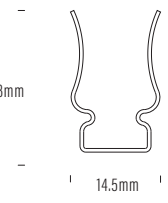
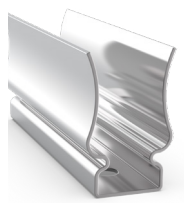
**AQS-500-ACC-01**  
Aluminium mounting clip

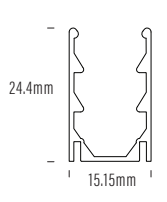
**AQS-500-ACC-AL2-01**  
1m Aluminium

**Standard profile.**

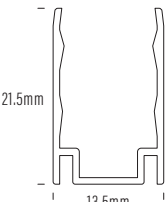
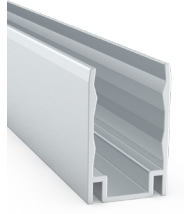

1. Use for horizontal applications.
2. Easier to remove Neon Flex once inserted.

**AQS-500-ACC-AL3-02**  
2m Aluminium

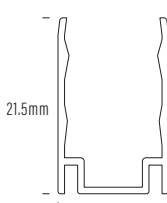
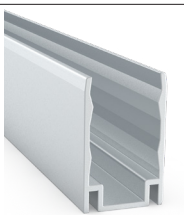
**AQS-500-ACC-AL4-01**  
Bendable S Channel



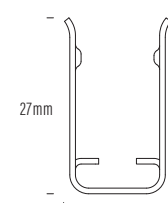

# Neon Flex

## Extrusion and End Cap allowances

### Assembly Notes

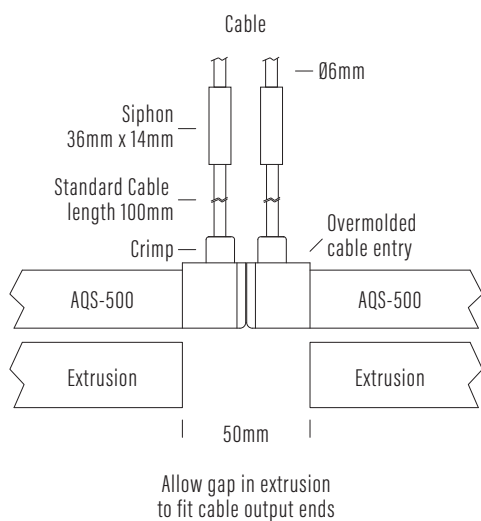
Quick Connector Output



Quick Connector Output

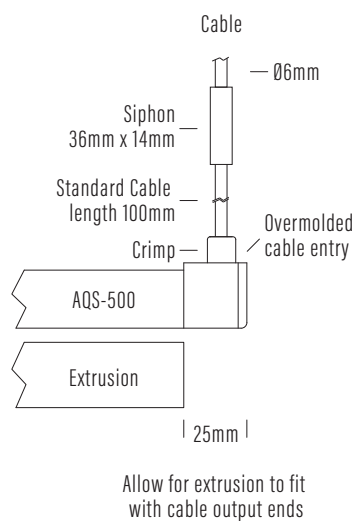

## Neon Flex

### AQS Family Reference Table

Product	Type	IP Rating	LED Options	Size mm	Power/m	Application
AQS-170	Cob Strip	IP20	Mono	10mm	5W / 10W / 15W DC	Internal / Profile required
AQS-172	Cob Strip	IP20	Mono	4mm	5W DC	Internal / Profile required
AQS-173	Cob Strip	IP20	RGBW	12mm	16W DC	Internal / Profile required
AQS-400	Neon Flex	IP65	Mono	9 x 10	5W / 10W DC	External / No profile required
AQS-401	Neon Flex	IP65	Mono	10 x 10	5W / 10W DC	External / No profile required
AQS-402	Neon Flex	IP65	Mono / RGB	6 x 12	5W / 10W DC	External / No profile required
AQS-410	Neon Flex	IP65	RGB	13 x 12	10W DC	External / No profile required
AQS-420	Neon Flex	IP65	Mono / RGBW	12 x 20	10W / 15W	External / No profile required
AQS-500	Neon Flex	IP68	Mono / RGB / RGBW / DMX	11.5 x 21	(Mono 5W / 8W / 12W) / 12W / 17W / 18W	External / Submerged / No profile
AQS-505	Neon Flex	IP68	Mono	13.5 x 13.5	10W	External / Submerged / No profile
AQS-510	Neon Flex	IP68	Mono / RGB / RGBW / DMX	16.5 x 16.5	10W / 13W / 17W / 18W	External / Submerged / No profile

### Extension Wire Recommendations

Maximum extension wire length according to light power

Watts	22AWG 0.34mm <sup>2</sup>	20AWG 0.53mm <sup>2</sup>	18AWG 0.82mm <sup>2</sup>	17AWG 1.04mm <sup>2</sup>	16AWG 1.38mm <sup>2</sup>	14AWG 2.07mm <sup>2</sup>	12AWG 3.29mm <sup>2</sup>	10AWG 5.62mm <sup>2</sup>
10W	36m	60m	100m	120m	140m	240m	400m	600m
20W	18m	30m	50m	60m	70m	120m	200m	300m
30W	12m	20m	30m	38m	45m	80m	130m	200m
40W	8m	15m	22m	28m	35m	60m	95m	140m
50W	6m	12m	18m	22m	28m	48m	75m	105m
60W	5m	10m	15m	18m	22m	36m	60m	88m
70W	-	8m	12m	14m	18m	30m	50m	72m
80W	-	6m	10m	11m	14m	24m	40m	58m
90W	-	4m	7m	8m	10m	18m	30m	45m
100W	-	-	5m	6m	7m	12m	22m	32m
110W	-	-	3m	4m	5m	8m	15m	22m
120W	-	-	2m	2.5m	3m	0m	8m	12m



# AQS-500 / RGBW

AQS-500 is a high output top-view IP68 Neon Flex. Use for external facade illumination, pool copings, in-pavement channels and exterior wall grazing where substantial moisture and mechanical protection is required.

# Neon Flex

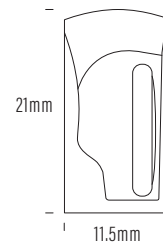
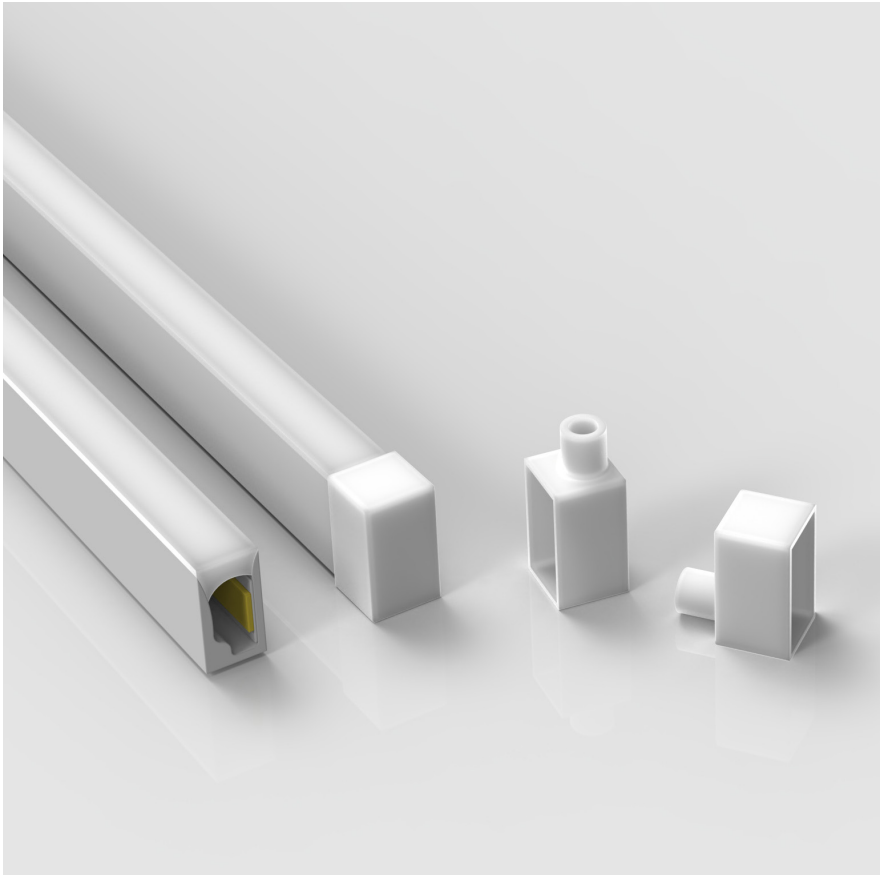

Products	AQS-500-RGBW
Voltage	24V DC
Watts (per Meter)	17W
IP Rating	IP68
Lumen Output (per Meter)	TBA
CCT & Colour Options	RGBW
Working Mode	Constant Voltage (PWM) / DMX
Max Length (Single Power Feed)	8m
Max Length (Double Power Feed)	16m
Cut Interval	100mm
Bend Direction	Horizontally
Minimum Bend Diameter	80mm
LED Type	SMD5050
LED Qty / M	60pcs
Lumen Maintenance	70,000 Hours L70@ 25°C, 50,000 Hours L70@ 50°C
Materials	Eco PVC
Emission Angle	120°
Operating Temperature	-20° to +40°C
Installation Temperature	5° to +35°C
Warranty	3 Year Aqualux Warranty

## Production Tolerances

The AQS-500 series Neon Flex product is manufactured in a continuous extrusion process and then manually terminated with IP68 overmolded cable entry points. Production tolerances need to be accounted for during site preparation.

- < 1M ±5mm
- < 5M Length ±10mm
- < 10M Length ±15mm
- < 20M ± 20mm

Refer to installation guide when planning your project.

For wiring diagrams please refer to the aqualux website: [www.aqualux.com.au](http://www.aqualux.com.au) / Support / Downloads / Wiring Diagrams

As with all IP68 products, the ingress protection is determined by the quality of the cable joins and installation.

# Neon Flex

## Variations

Product Code	CCT Kelvin	Voltage Direct Current	Watts Meter	Lumens Meter	Min Run Single End	Max Run Double End
AQS-500-Z2A17	RGB 3000k	24V DC	17W	TBA	8m	16m
AQS-500-Z3A17	RGB 2700k	24V DC	17W	TBA	8m	16m
AQS-500-Z4A17	RGB 6500k	24V DC	17W	TBA	8m	16m
AQS-500-Z0A17 (Custom)	RGB 4000k	24V DC	17W	TBA	8m	16m

### Bending Directions

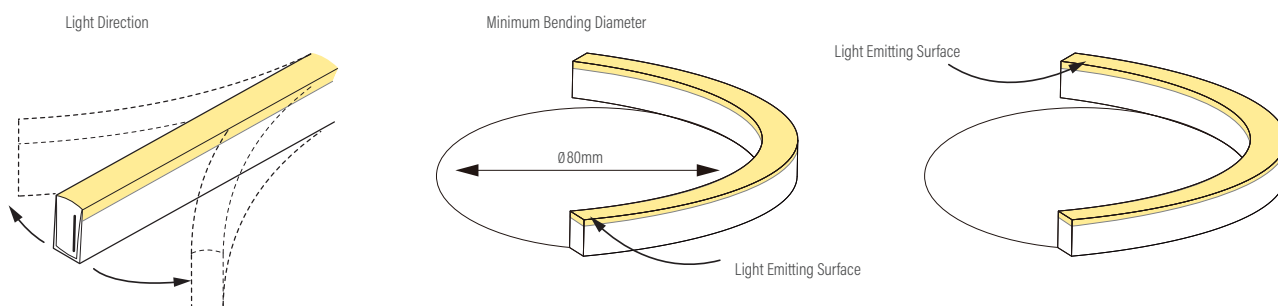

## Quick Connect Cable Entry Options

- Integrated non-removeable anti-siphon device
- IP68 factory assembly only
- Injection Moulded Connectors

### Direct Cable Entry

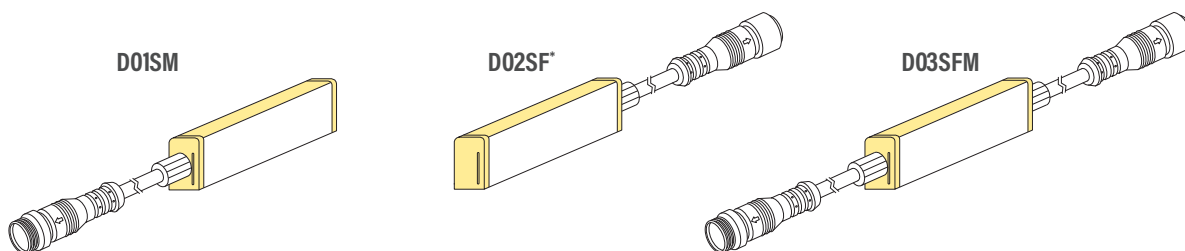

\*For use in DMX / SPI signal flow direction.

### Side Cable Entry

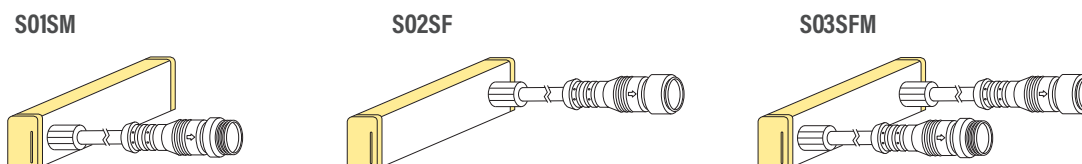

### Bottom Cable Entry

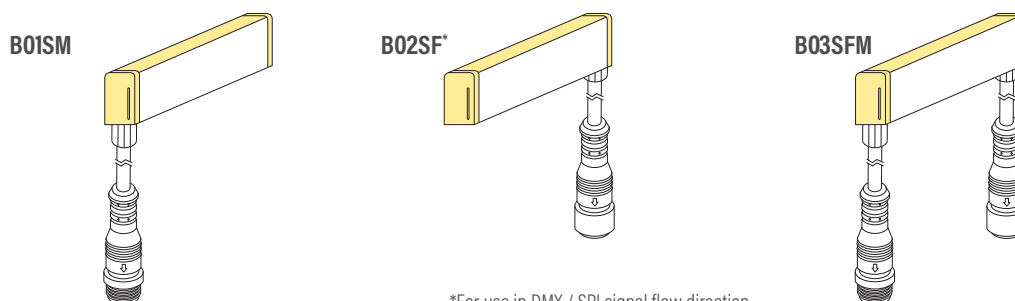

\*For use in DMX / SPI signal flow direction.

# Neon Flex

## Quick Connector Dimensions

### Direct Cable Entry

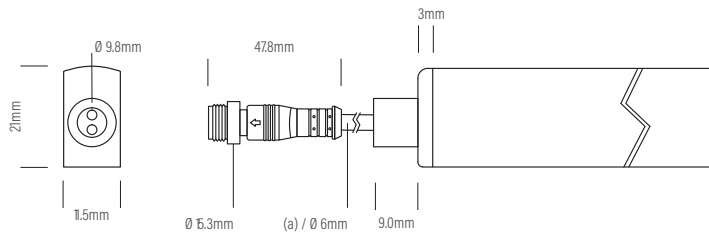

(a) = Minimum length of 6 - 8mm

### Side Cable Entry

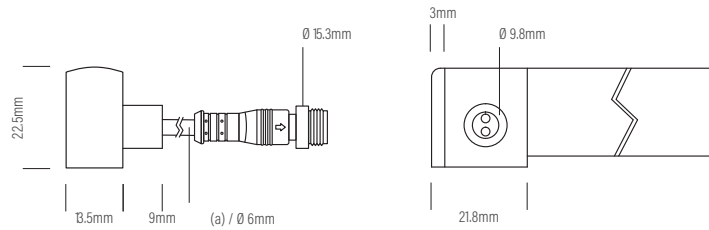

(a) = Minimum length of 6 - 8mm

### Bottom Cable Entry

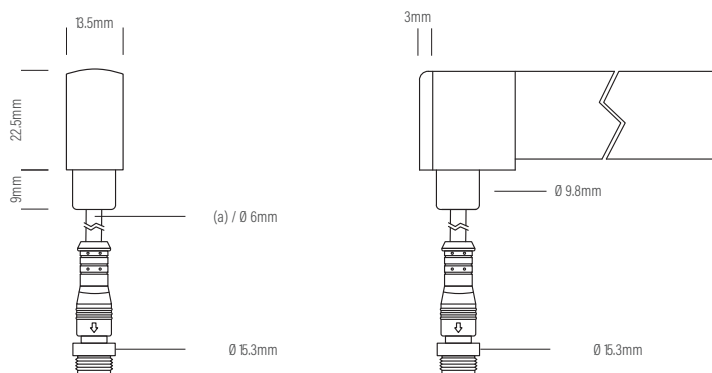

(a) = Minimum length of 6 - 8mm

# Neon Flex

## Mounting

AQS-500-ACC-AL-01  
1m Aluminium

**Anti-slip profile.**

1. More aggressive retention of Neon Flex.
2. Harder to remove once inserted.
3. Use for vertical or inverted mounting applications.

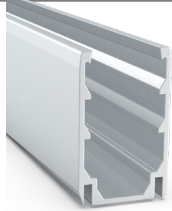
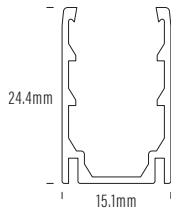

AQS-500-ACC-AL-02  
2m Aluminium

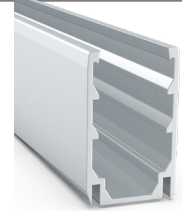
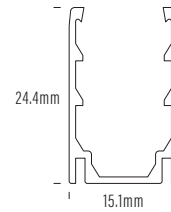

AQS-500-ACC-AL-04  
1m Polycarbonate

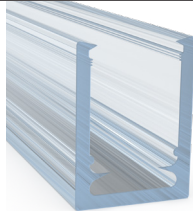
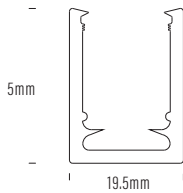

AQS-500-ACC-AL-01-SS  
316SS mounting clip

**Application.**

1. Pools and High Corrosive areas.

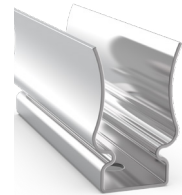
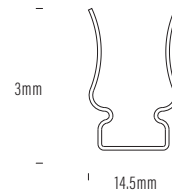

AQS-500-ACC-01  
Aluminium mounting clip

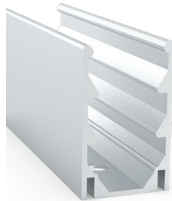
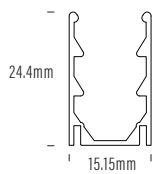

AQS-500-ACC-AL2-01  
1m Aluminium

**Standard profile.**

1. Use for horizontal applications.
2. Easier to remove Neon Flex once inserted.

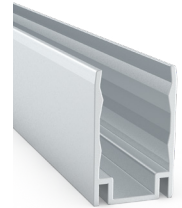
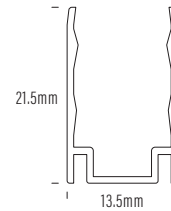

AQS-500-ACC-AL3-02  
2m Aluminium

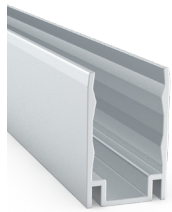
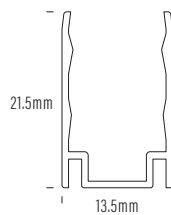

# Neon Flex

## Extrusion and End Cap allowances

Assembly Notes

Quick Connector Output

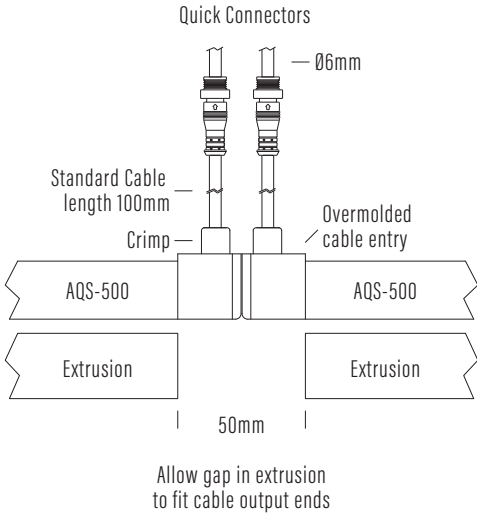

Quick Connector Output

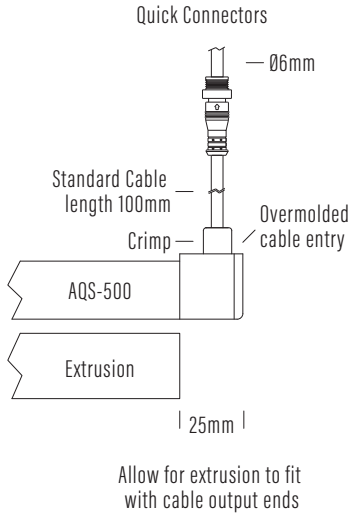

## Neon Flex

### AQS Family Reference Table

Product	Type	IP Rating	LED Options	Size mm	Power/m	Application
AQS-170	Cob Strip	IP20	Mono	10mm	5W / 10W / 15W DC	Internal / Profile required
AQS-172	Cob Strip	IP20	Mono	4mm	5W DC	Internal / Profile required
AQS-173	Cob Strip	IP20	RGBW	12mm	16W DC	Internal / Profile required
AQS-400	Neon Flex	IP65	Mono	9 x 10	5W / 10W DC	External / No profile required
AQS-401	Neon Flex	IP65	Mono	10 x 10	5W / 10W DC	External / No profile required
AQS-402	Neon Flex	IP65	Mono / RGB	6 x 12	5W / 10W DC	External / No profile required
AQS-410	Neon Flex	IP65	RGB	13 x 12	10W DC	External / No profile required
AQS-420	Neon Flex	IP65	Mono / RGBW	12 x 20	10W / 15W	External / No profile required
AQS-500	Neon Flex	IP68	Mono / RGB / RGBW / DMX	11.5 x 21	(Mono 5W / 8W / 12W) / 12W / 17W / 18W	External / Submerged / No profile
AQS-505	Neon Flex	IP68	Mono	13.5 x 13.5	10W	External / Submerged / No profile
AQS-510	Neon Flex	IP68	Mono / RGB / RGBW / DMX	16.5 x 16.5	10W / 13W / 17W / 18W	External / Submerged / No profile

### Extension Wire Recommendations

Maximum extension wire length according to light power

Watts	22AWG 0.34mm <sup>2</sup>	20AWG 0.53mm <sup>2</sup>	18AWG 0.82mm <sup>2</sup>	17AWG 1.04mm <sup>2</sup>	16AWG 1.38mm <sup>2</sup>	14AWG 2.07mm <sup>2</sup>	12AWG 3.29mm <sup>2</sup>	10AWG 5.62mm <sup>2</sup>
10W	36m	60m	100m	120m	140m	240m	400m	600m
20W	18m	30m	50m	60m	70m	120m	200m	300m
30W	12m	20m	30m	38m	45m	80m	130m	200m
40W	8m	15m	22m	28m	35m	60m	95m	140m
50W	6m	12m	18m	22m	28m	48m	75m	105m
60W	5m	10m	15m	18m	22m	36m	60m	88m
70W	-	8m	12m	14m	18m	30m	50m	72m
80W	-	6m	10m	11m	14m	24m	40m	58m
90W	-	4m	7m	8m	10m	18m	30m	45m
100W	-	-	5m	6m	7m	12m	22m	32m
110W	-	-	3m	4m	5m	8m	15m	22m
120W	-	-	2m	2.5m	3m	0m	8m	12m