

Musical Note

6" Finished (6.5" Unfinished)

Read Help  before printing

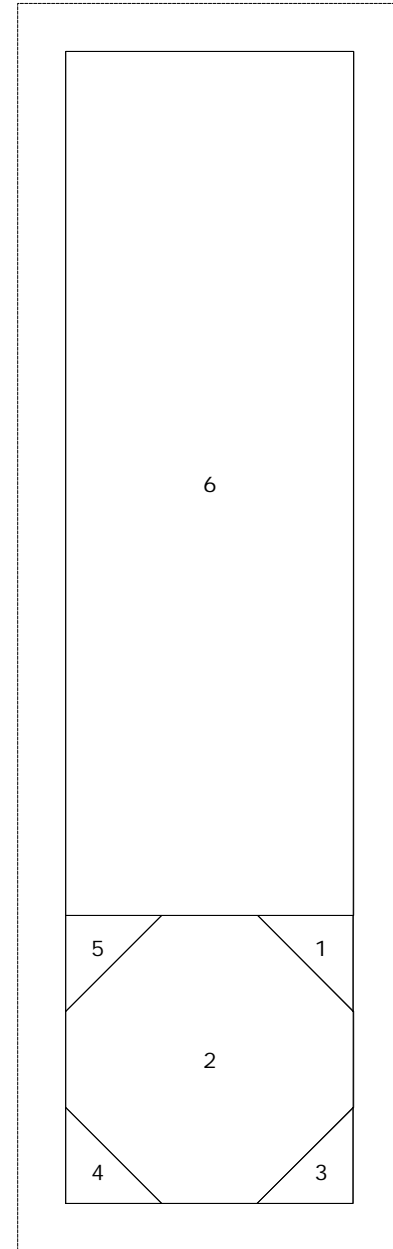
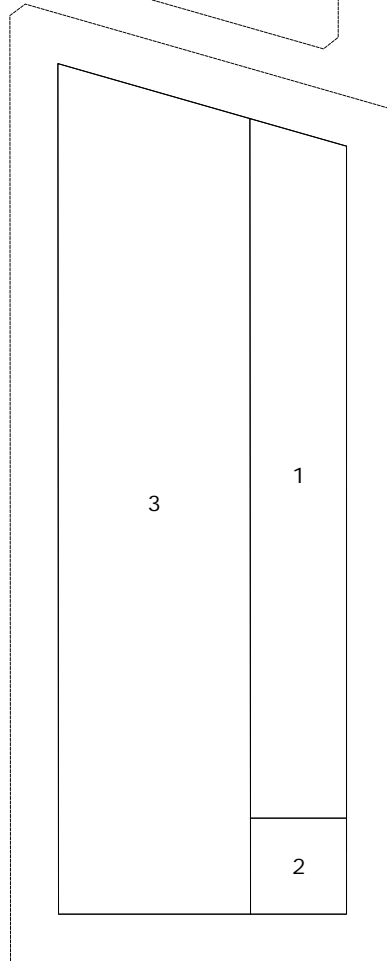
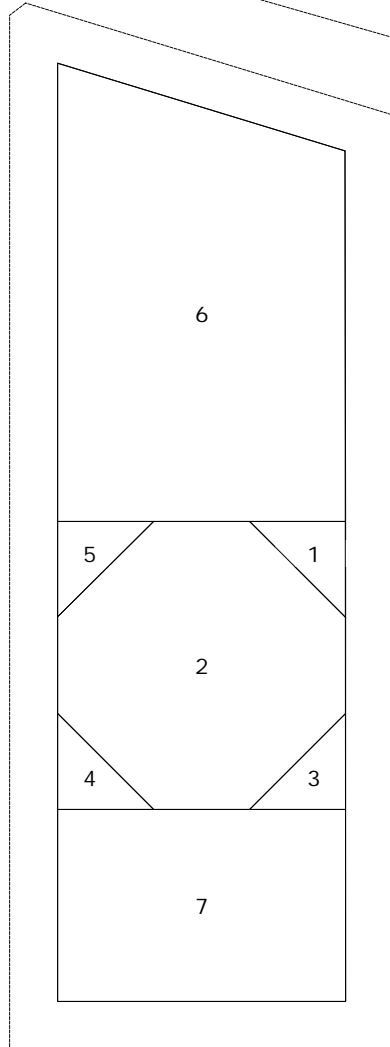
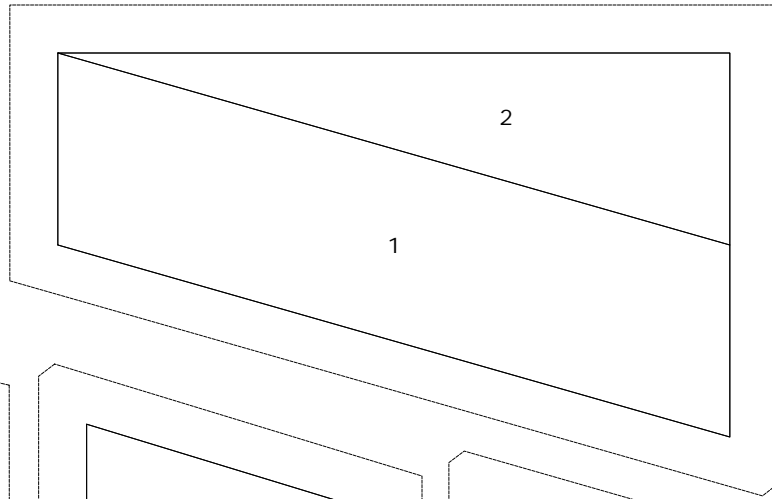
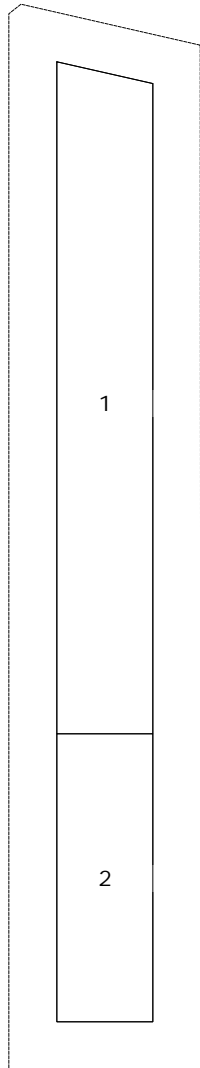
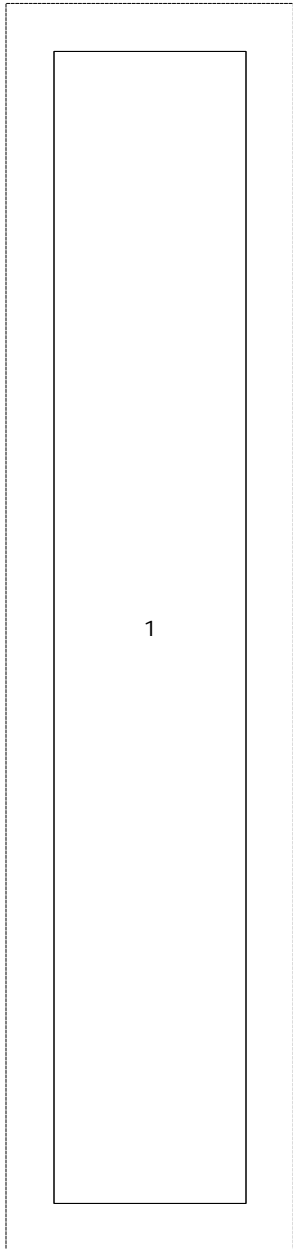

Cut sections
apart before
sewing.

Place
fabric on the
reverse side.