

SUPER LINE&PRO

DESIGNED BY FLOS ARCHITECTURAL

**SUPER LINE
UP&DOWN
INDIRECT**



LIGHT SOURCE
TOP LED
58W
4488 lm UP
2160 lm DOWN
3000K/CRI 90

4794 lm UP
2280 lm DOWN
4000K/CRI 90

**SUPER LINE
UP&DOWN
DIRECT**



LIGHT SOURCE
TOP LED
58W
2268 lm UP
4488 lm DOWN
3000K/CRI 90

2376 lm UP
4794 lm DOWN
4000K/CRI 90

**SUPER LINE
DOWN**



LIGHT SOURCE
TOP LED
38,6W
4488 lm
3000K/CRI 90
4794 lm
4000K/CRI 90

**SUPER LINE PRO
UP&DOWN**



LIGHT SOURCE
TOP LED
60W
UP TO 4075 lm UP
UP TO 4605 lm DOWN
3000K/CRI 90

UP TO 4337 lm UP
UP TO 4900 lm DOWN
4000K/CRI 90

**SUPER LINE PRO
DOWN**



LIGHT SOURCE
TOP LED
40W
UP TO 5072 lm
3000K/CRI 90
UP TO 4765 lm
4000K/CRI 90

□ 40 Bianco
40 White

■ 02 Grigio
02 Grey

■ 14 Nero
14 Black

■ ET Ottone Spazzolato
ET Brushed Brass

■ EU Oro rosa Spazzolato
EU Brushed Rose Gold

Super Line

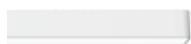

Super Line Pro



Super Line

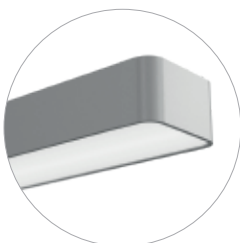

Super Line Pro



SUPER LINE & PRO

Descrizione

Collezione di apparecchi di illuminazione sospesi per illuminazione generale con la firma di un design minimalista, disegnata per offrire illuminazione ad alto rendimento, qualità della luce e confort visivo combinato in un formato ultracompatto.

La versione Super Line Pro è stata sviluppata appositamente per soddisfare tutti i requisiti per il controllo dell'abbagliamento e il confort visivo negli spazi di lavoro. Offre un UGR inferiore a 14 e un valore di intensità massima per angoli di 65° secondo la norma inferiore a 3000 cd/m², garantendo le migliori condizioni negli ambienti di lavoro e in innumerevoli altre applicazioni. (Vedi tabella UGR nella sezione accessori).

Il corpo principale degli apparecchi d'illuminazione è fabbricato in alluminio estruso. Il Super Line è dotato di un filtro diffusore tecnico multistrato che, grazie alla combinazione di filtri prismatici ed ellittici, assicura una distribuzione perfetta della luce e migliora l'effetto ottico e il confort visivo mediante le sue proprietà antiabbagliamento.

Super Line Up & Down è disponibili in due versioni:

- Indirect: versione che privilegia l'emissione indiretta verso l'alto, con un'intensità luminosa indiretta più importante, che rende omogeneo l'ambiente di illuminazione, disegnata per offrire un UGR<19e la condizione luminosa ideale richiesta negli uffici.

- Direct: versione che privilegia l'illuminazione diretta e massimizza l'efficienza, prevenendo contemporaneamente l'effetto "caverna" con la sua intensità indiretta, garantendo un elevato livello di confort.

Super Line Pro Up&Down comprende un' unica versione che può essere regolata tramite il driver corrispondente per offrire una maggiore quantità di flusso nell'emissione superiore o inferiore.

Per minimizzare l'impatto visivo della collezione, i conduttori fungono da cavi di sospensione, eliminando così la canalina di alimentazione. Lunghezza di sospensione 4,25m.

Informazioni di Installazione

Super Line è fabbricata combinando il modulo di alimentazione selezionato con uno di questi tre kit d'installazione esistenti:

- Surface Kit: comprende cassetta a incasso con il driver di alimentazione.

- Integrated Kit: comprende cassetta di installazione a incasso, con il driver di alimentazione.

- Remote Power Supply Kit: comprende protezione accessoria per il cavo che attraversa il cartongesso.

Tutti i kit di installazione sono disponibili sia nella versione DALI che in quella non dimmerabile.

Super Line Pro dispone degli stessi Kit di alimentazione. Per la versione UP&Down gli alimentatori sono provvisti di due uscite verso l'apparecchio, ognuna delle quali presenta un'intensità di corrente dedicata (mA). Collegando le due uscite rispettivamente ad ognuna delle due entrate (Up o Down) dell'apparecchio è possibile associare il flusso maggioritario e quello minoritario all'emisfero superiore o a quello inferiore.

Le versioni non dimmerabili sono provviste di un driver multi-corrente, che può essere attivato durante l'installazione per ottenere le condizioni di illuminazione richieste. I kit di installazione Super Line vengono forniti dalla fabbrica al 100% della potenza nominale.

Tutti gli apparecchi sono provvisti di una livella circolare ad alta precisione, che semplifica l'installazione dell'apparecchio, controllando la calibrazione di entrambe le assi.

Informazioni Aggiuntive

Classe d'isolation I.

Grado di protezione IP20.

Conformità e Marchi di Qualità

Apparecchio conforme alla Normativa Tecnica Europea EN60598-1 e relative parti seconde.

Description

Collection of suspended luminaries for general lighting with a signature minimalist shape, designed to offer high-performance lighting, light quality and visual comfort combined in a very compact size.

The Super Line Pro version was designed to meet all requirements to reduce glare and improve visual comfort in offices, complying with the most restrictive conditions. A UGR less than 14 and a maximum intensity value less than 3000 cd/m² at an angle of 65° according to the standard, guarantee the best conditions for workplaces and make it perfect for many other applications. (Refer to the UGR chart in the accessories section).

The main body of the lights is made from extruded aluminium. Super Line is equipped with a multilayer diffusion filter which, thanks to its combination of elliptical and prism-shaped filters, ensures that the light is perfectly distributed and improves the overall visual effect, as well as providing comfort with its anti-glare properties.

Super Line Up&Down is available in two different versions:

- Indirect: a version which is better for emitting light indirectly upwards, with a greater intensity of indirect luminosity that homogenizes the lighting area, designed to provide UGR<19 and the perfect lighting conditions for offices.

- Direct: a version which is better for direct lighting and maximises efficiency, but at the same time prevents any "cave effect" with its indirect intensity, guaranteeing a high level of comfort.

Super Line Pro Up&Down comes in only one version that can be adjusted using the corresponding driver to offer a higher flux in the upper or lower part.

To minimise the visual impact of the collection, the suspension cables are also the wires, which eliminates the need for a power supply cable. Suspension length: 4.25 meters.

Installation Information

The Super Line is constructed combining the selected light source module with one of the three existing installation kits:

- Surface Kit: includes surface mounted box including the power supply driver.

- Integrated Kit: includes flush-recessed installation box, including power supply driver.

- Remote Power Supply Kit: includes an accessory as pass-through cable protection as well as a power supply driver for a remote accessible installation.

All installation kits are available either in DALI version or in a non dimmable version.

Super Line Pro uses the same power kits. For the Up&Down version, the power sources have two outputs to the light fitting, each with an amount of current (mA). By connecting each of these outputs to an input of the light fitting (Up or Down), a higher or lower flux can be chosen for each part.

The non dimmable versions are equipped with a multi-current driver that can be set during the installation in order to achieve the required illumination conditions. The Super Line installation kits come from factory at 100% of their nominal power.

All luminaires host a high-precision circular level, simplifying the installation of the luminaire, controlling calibration in both axes.

Additional Information

Insulation class I.

IP20 protection grade.

Standard Compliance and Quality Marks

EN60598-1 European Technical Standards and any subsequent additions.

Super Line Up&Down Indirect

Light Source: Top LED 58W - 4488 lm UP - 2160 lm DOWN - 3000K/CRI 90 / 58W - 4794 lm UP - 2280 lm DOWN - 4000K/CRI 90

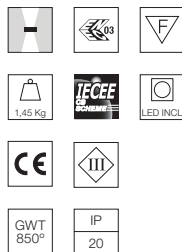
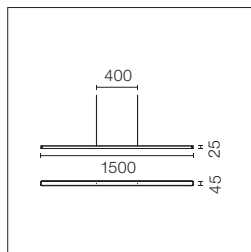

Apparecchio di illuminazione LED generale diretta e indiretta con design minimalista distintivo e compatto, adatto per installazione a soffitto mediante sospensione. Fonte di alimentazione compresa nei diversi kit di installazione che devono essere ordinati separatamente.

LED luminaire for direct and indirect lighting with a signature minimalist and compact design, to be installed on ceilings by means of suspension. Power source included in installation kits must be ordered separately.

- 3000K**
- 03.9502.40
 - 03.9502.02
 - 03.9502.14
 - 03.9502.ET
 - 03.9502.EU

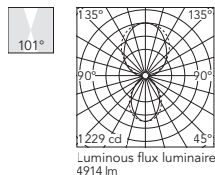

h(m)	E(lx)	D(m)
1	1229	2.39
2	307	4.78
3	137	7.17
4	77	9.57
5	49	11.96

- 4000K**
- 03.9503.40
 - 03.9503.02
 - 03.9503.14
 - 03.9503.ET
 - 03.9503.EU

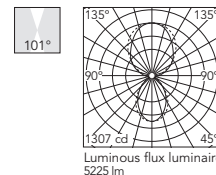

h(m)	E(lx)	D(m)
1	1307	2.39
2	327	4.78
3	145	7.17
4	82	9.57
5	52	11.96

Super Line Up&Down Direct

Light Source: Top LED 58W - 2268 lm UP - 4488 lm DOWN - 3000K/CRI 90 / 58W - 2376 lm UP - 4794 lm DOWN - 4000K/CRI 90

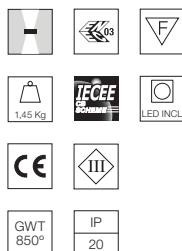
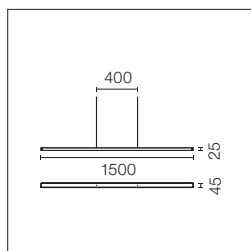

Apparecchio di illuminazione LED generale diretta e indiretta con design minimalista distintivo e compatto, adatto per installazione a soffitto mediante sospensione. Fonte di alimentazione compresa nei diversi kit di installazione che devono essere ordinati separatamente.

LED luminaire for direct and indirect lighting with a signature minimalist and compact design, to be installed on ceilings by means of suspension. Power source included in installation kits must be ordered separately.

- 3000K**
- 03.9500.40
 - 03.9500.02
 - 03.9500.14
 - 03.9500.ET
 - 03.9500.EU

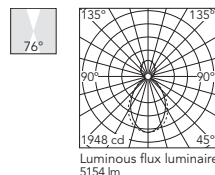

h(m)	E(lx)	D(m)
1	1948	1.57
2	487	3.13
3	216	4.70
4	122	6.27
5	78	7.84

- 4000K**
- 03.9501.40
 - 03.9501.02
 - 03.9501.14
 - 03.9501.ET
 - 03.9501.EU

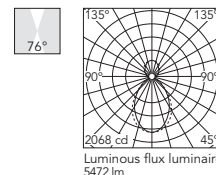

h(m)	E(lx)	D(m)
1	2068	1.57
2	517	3.13
3	230	4.70
4	129	6.27
5	83	7.84

Super Line Down

Light Source: Top LED 38,5W - 4488 lm - 3000K/CRI 90 / 38,5W - 4794 lm - 4000K/CRI 90

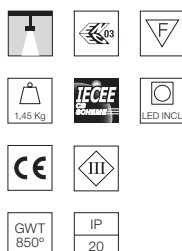
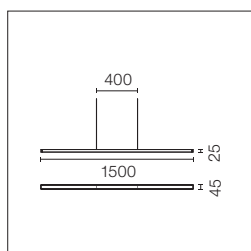

Apparecchio di illuminazione LED generale con design minimalista distintivo e compatto, adatto per installazione a soffitto mediante sospensione. Fonte di alimentazione compresa nei diversi kit di installazione, che devono essere ordinati separatamente.

LED luminaire for general lighting with a signature minimalist and compact design, to be installed on ceilings by means of suspension. Power source included in installation kits must be ordered separately.

- 3000K**
- 03.9510.40
 - 03.9510.02
 - 03.9510.14
 - 03.9510.ET
 - 03.9510.EU

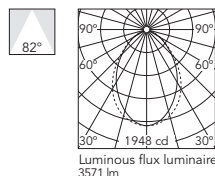

h(m)	E(lx)	D(m)
1	1948	1.57
2	487	3.13
3	216	4.70
4	122	6.27
5	78	7.84

- 4000K**
- 03.9511.40
 - 03.9511.02
 - 03.9511.14
 - 03.9511.ET
 - 03.9511.EU

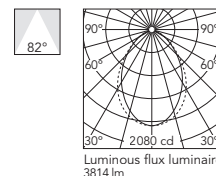

h(m)	E(lx)	D(m)
1	2080	1.57
2	520	3.13
3	231	4.70
4	130	6.27
5	83	7.84

SUPER LINE & PRO

Super Line Pro Up&Down

Light Source: Majority UP - Top LED 60W - 4075 lm UP - 2500 lm DOWN - 3000K/CRI 90 / 60W - 4335 lm UP - 2660 lm DOWN - 4000K/CRI 90
Majority DOWN - Top LED 60W - 2590 lm UP - 4605 lm DOWN - 3000K/CRI 90 / 60W - 2755 lm UP - 4900 lm DOWN - 4000K/CRI 90

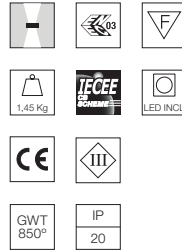
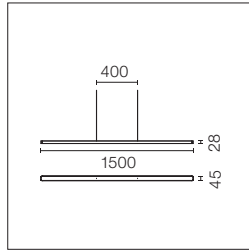

Apparecchio di illuminazione LED generale diretta e indiretta con design minimalista distintivo e compatto, adatto per installazione a soffitto mediante sospensione. Fonte di alimentazione compresa nei diversi kit di installazione che devono essere ordinati separatamente. La selezione della maggiore intensità Up o Down si realizza nei kit di alimentazione che includono un driver con due uscite indipendenti.

LED luminaire for direct and indirect lighting with a signature minimalist and compact design, to be installed on ceilings by means of suspension. Power source included in installation kits must be ordered separately. Greater Up or Down intensity can be selected using power kits with a device with two independent outputs.

3000K

- 03.9560.40
- 03.9560.02
- 03.9560.14
- 03.9560.ET
- 03.9560.EU

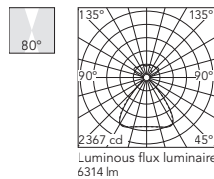
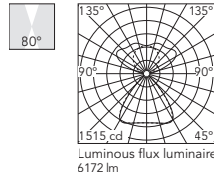

@White (40)

4000K

- 03.9561.40
- 03.9561.02
- 03.9561.14
- 03.9561.ET
- 03.9561.EU

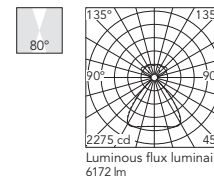
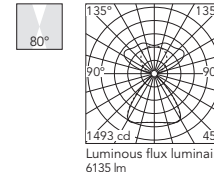

@White (40)

Super Line Pro Down

Light Source: Top LED 40W - 4765 lm - 3000K/CRI 90 / 40W- 5070 lm - 4000K/CRI 90

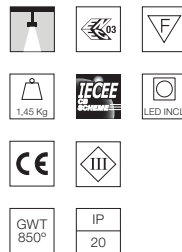
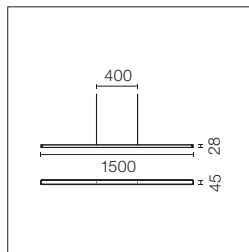

Apparecchio di illuminazione LED generale con design minimalista distintivo e compatto, adatto per installazione a soffitto mediante sospensione. Fonte di alimentazione compresa nei diversi kit di installazione, che devono essere ordinati separatamente, potendo selezionare l'intensità massima.

LED luminaire for general lighting with a signature minimalist and compact design, to be installed on ceilings by means of suspension. Power source included in installation kits must be ordered separately, allowing the maximum brightness to be selected.

3000K

- 03.9570.40
- 03.9570.02
- 03.9570.14
- 03.9570.ET
- 03.9570.EU

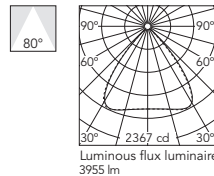

@White (40)

4000K

- 03.9571.40
- 03.9571.02
- 03.9571.14
- 03.9571.ET
- 03.9571.EU

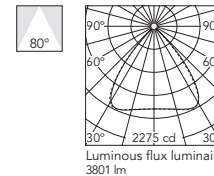

@White (40)

Accessori / Accessories

Le versioni non dimmerabili di Super Line e Super Line Pro Down sono equipaggiate con un'alimentazione di corrente multipla che può essere configurata durante l'installazione dell'apparecchio per adattare le condizioni di illuminazione e il livello di comfort visivo richiesti. Il kit di installazione viene fornito dalla fabbrica al 100% della potenza nominale (1050 mA). Super Line Pro soddisfa in tutte le sue versioni e a massima potenza i parametri di UGR<19 e L65°<3000 cd.

The non-adjustable versions of Super Line and Super Line Pro Down are equipped with a multi-current driver, that can be set during the installation in order to achieve the required illumination conditions and comfort levels. Installation kits come from factory at 100% of their nominal power (1050 mA). At maximum power, all versions of Super Line Pro comply with the requirements UGR<19 and L 65°<3000 cd.

Super Line

Driver setting	Light emission	Indirect		Direct	
		UGR*	L 65° < 3000 cd	UGR*	L 65° < 3000 cd
1050 mA	100%	UGR < 19			
850 mA	80%	UGR < 19			
700 mA	70%	UGR < 19			
550 mA	55%	UGR < 19	√		
500 mA	50%	UGR < 19	√	UGR < 19	√
350 mA	36%	UGR < 19	√	UGR < 19	√

*X=4H, Y=8H, S=0.25H, reflections 70/50/20

Super Line Pro

Light emission	UGR*	L 65° < 3000 cd
Up & Down Majority Up	UGR < 14	√
Up & Down Majority Down	UGR < 17	√
Down	UGR < 18	√

Super Line / Super Line Pro Down

Surface Power Supply Kit

Comprende fonte di alimentazione 60W - 220/240V. I Kit per Super Line e Super Line Pro Down dispongono di driver con dip-switch per selezionare l'intensità massima richiesta.

60W - 220/240V power supply included. Kits for Super Line and Super Line Pro Down are equipped with a dip-switch driver to select the maximum intensities.

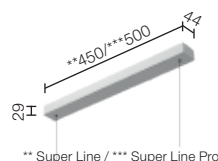

- Non Dimmable
- 08.0520.40A
 - 08.0520.02A
 - 08.0520.14A
 - 08.0520.ETA
 - 08.0520.EUA
- Dali Version*
- 08.0521.40A
 - 08.0521.02A
 - 08.0521.14A
 - 08.0521.ETA
 - 08.0521.EUA

Super Line Pro Up&Down

Surface Power Supply Kit

Include driver 85W - 220/240V. I Kit per Super Line Pro Up&Down dispongono di due uscite per permettere di scegliere quale emissione (Up o Down) disporrà di un'intensità maggiore.

85W - 220/240V power supply included. Kits for Super Line Pro Up&Down are equipped with two outputs to select which part (Up or Down) is brighter.

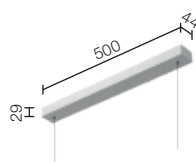

- Non Dimmable/Dali Version
- 08.0640.40
 - 08.0640.02
 - 08.0640.14
 - 08.0640.ET
 - 08.0640.EU

Super Line / Super Line Pro Down

Recessed Power Supply Kit

Comprende fonte di alimentazione 60W - 220/240V. I Kit per Super Line e Super Line Pro Down dispongono di driver con dip-switch per selezionare l'intensità massima richiesta.

60W - 220/240V power supply included. Kits for Super Line and Super Line Pro Down are equipped with a dip-switch driver to select the maximum intensities.

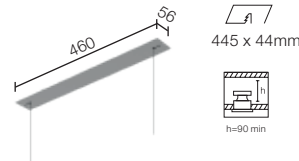

- Non Dimmable
- 08.0522.40A
 - 08.0522.02A
 - 08.0522.14A
 - 08.0522.ETA
 - 08.0522.EUA
- Dali Version*
- 08.0523.40A
 - 08.0523.02A
 - 08.0523.14A
 - 08.0523.ETA
 - 08.0523.EUA

Super Line Pro Up&Down

Recessed Power Supply Kit

Include driver 85W - 220/240V. I Kit per Super Line Pro Up&Down dispongono di due uscite per permettere di scegliere quale emissione (Up o Down) disporrà di un'intensità maggiore.

85W - 220/240V power supply included. Kits for Super Line Pro Up&Down are equipped with two outputs to select which part (Up or Down) is brighter.

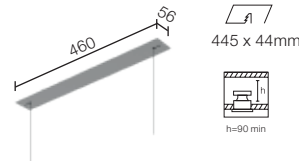

- Non Dimmable/Dali Version
- 08.0641.40
 - 08.0641.02
 - 08.0641.14
 - 08.0641.ET
 - 08.0641.EU

Accessori / Accessories

Super Line / Super Line Pro Down

Remote Power Supply Kit

Fornito con due kit sospensione e una fonte di alimentazione a 60W - 220/240V. I Kit per Super Line e Super Line Pro Down dispongono di driver con dip-switch per selezionare l'intensità massima richiesta.

Includes two suspension kits and a 60W - 220/240V power supply. Kits for Super Line and Super Line Pro Down are equipped with a dip-switch driver to select the maximum intensities.



- Non Dimmable
- 08.0524.40
- 08.0524.02
- 08.0524.14
- 08.0524.ET
- 08.0524.EU
- Dali Version*
- 08.0525.40
- 08.0525.02
- 08.0525.14
- 08.0525.ET
- 08.0525.EU

Super Line Pro Up&Down

Remote Power Supply Kit

Fornito con due kit di sospensione e due fonte di alimentazione da 45W - 220/240V. I Kit per Super Line Pro Up&Down dispongono di due uscite per permettere di scegliere quale emissione (Up o Down) disporrà di un'intensità maggiore.

Includes two suspension kits and two 45W - 220/240V power supplies. Kits for Super Line Pro Up&Down are equipped with two outputs to select which part (Up or Down) is brighter.



- Non Dimmable/Dali Version
- 08.0642.40
- 08.0642.02
- 08.0642.14
- 08.0642.ET
- 08.0642.EU

Installation Sequence

Recessed Power Supply Kit

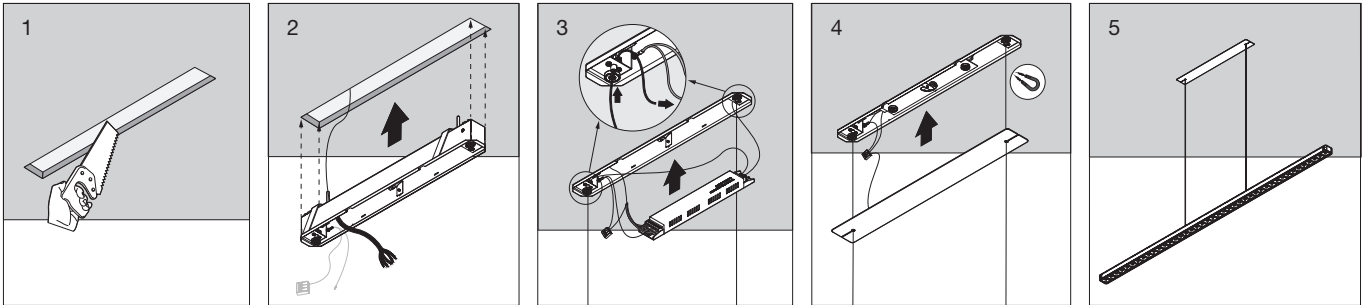

Surface Power Supply Kit

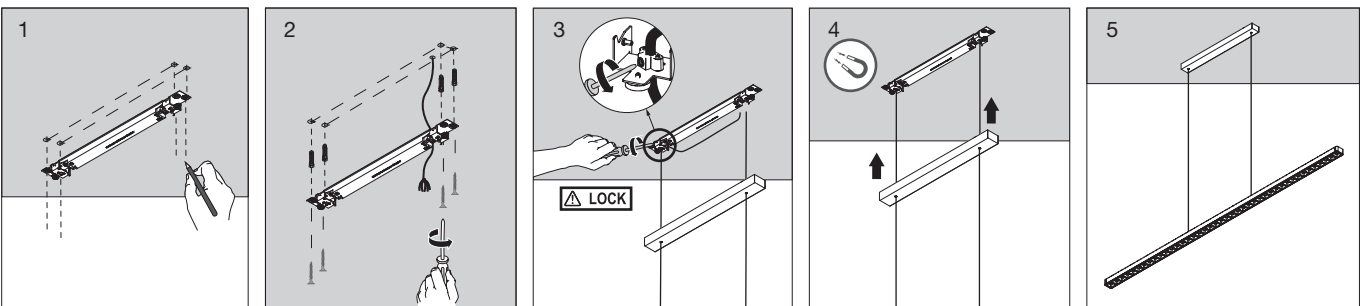

Remote Power Supply Kit

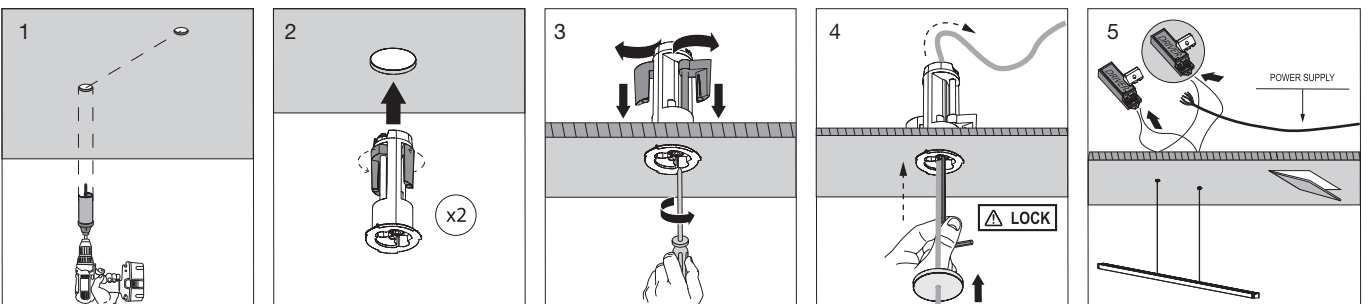

* Per versioni 1-10V e Push, consultare il Front Office/Ufficio tecnico / For 1-10V and Push versions, please ask the Front Office/Technical Department.