

# STANLEY®

## CD12 HYDRAULIC CORE DRILL



### USER MANUAL Safety, Operation and Maintenance



© 2014 STANLEY Black & Decker, Inc.  
New Britain, CT 06053  
U.S.A.  
62379 8/2018 Ver. 9



# TABLE OF CONTENTS

SAFETY SYMBOLS.....	4
SAFETY PRECAUTIONS .....	5
TOOL STICKERS & TAGS .....	6
HOSE TYPES .....	7
HOSE RECOMMENDATIONS.....	8
HTMA / EHTMA REQUIREMENTS .....	9
OPERATION .....	10
TOOL PROTECTION & CARE.....	13
TROUBLESHOOTING .....	14
SPECIFICATIONS .....	16
ACCESSORIES .....	16
SERVICE PARTS.....	16
CD12 PARTS ILLUSTRATION.....	17
CD12 PARTS LIST.....	18
CD12 ANCHOR STAND ILLUSTRATION .....	19
CD12 ANCHOR STAND PARTS LIST .....	20

## IMPORTANT

To fill out a product warranty validation form, and for information on your warranty, visit [www.stanleyinfrastructure.com](http://www.stanleyinfrastructure.com) and select the Company tab > Warranty.

**Note:** The warranty validation record must be submitted to validate the warranty.

**SERVICING:** This manual contains safety, operation and routine maintenance instructions. STANLEY Infrastructure recommends that servicing of hydraulic tools, other than routine maintenance, must be performed by an authorized and certified dealer. Please read the following warning.

## ⚠ WARNING

**SERIOUS INJURY OR DEATH COULD RESULT FROM THE IMPROPER REPAIR OR SERVICE OF THIS TOOL.**

**REPAIRS AND / OR SERVICE TO THIS TOOL MUST ONLY BE DONE BY AN AUTHORIZED AND CERTIFIED DEALER.**

For the nearest certified dealer, call STANLEY Infrastructure at (503) 659-5660 and ask for a Customer Service Representative.

# SAFETY SYMBOLS

Safety symbols and signal words, as shown below, are used to emphasize all operator, maintenance and repair actions which, if not strictly followed, could result in a life-threatening situation, bodily injury or damage to equipment.



This is the safety alert symbol. It is used to alert you to potential personal injury hazards. Obey all safety messages that follow this symbol to avoid possible injury or death.



This safety alert and signal word indicates an imminently hazardous situation which, if not avoided, will result in death or serious injury.



This safety alert and signal word indicates a potentially hazardous situation which, if not avoided, could result in death or serious injury.



This safety alert and signal word indicates a potentially hazardous situation which, if not avoided, could result in death or serious injury.

CAUTION

This signal word indicates a potentially hazardous situation which, if not avoided, may result in property damage.

NOTICE

This signal word indicates a situation which, if not avoided, will result in damage to the equipment.



This signal word indicates a situation which, if not avoided, may result in damage to the equipment.

Always observe safety symbols. They are included for your safety and for the protection of the tool.

## LOCAL SAFETY REGULATIONS

Enter any local safety regulations here. Keep these instructions in an area accessible to the operator and maintenance personnel.

---

---

---

---

---

---

---

---

---

---

---

---

---

---

---

---

---

---

---

---

---

---

# SAFETY PRECAUTIONS

Tool operators and maintenance personnel must always comply with the safety precautions given in this manual, and on the stickers and tags attached to or on the tool and hoses.

These safety precautions are for your safety. Review them carefully before operating the tool or performing any maintenance or repairs.

Supervising personnel may specify additional precautions for your work area to comply with company policies and local safety regulations. Enter any added precautions in the space provided in this manual.

The CD12 Hydraulic Core Drill will provide safe and dependable service if operated in accordance with the instructions given in this manual. Read and understand this manual and any stickers and tags attached to the tool and hoses before operation. Failure to do so could result in personal injury or equipment damage.



- Operator must start in a work area without bystanders. Flying debris can cause serious injury.
  - The operator must be familiar with all prohibited work areas such as excessive slopes and dangerous terrain conditions.
  - Establish a training program for all operators to ensure safe operations.
  - Do not operate the tool unless thoroughly trained or under the supervision of an instructor.
  - Always wear safety equipment such as goggles, head protection and safety shoes at all times when operating the tool.
  - Do not inspect or clean the tool while the hydraulic power source is connected. Accidental engagement of the tool can cause serious injury.
  - Do not operate this tool without first reading the Operating Instructions.
  - Never operate the tool if you cannot be sure that underground utilities are not present. Underground electrical utilities present an electrocution hazard. Underground gas utilities present an explosion hazard. Other underground utilities may present other hazards.
  - Do not wear loose fitting clothing when operating the tool. Loose fitting clothing can get entangled with the tool and cause serious injury.
- Supply hoses must have a minimum working pressure rating of 2500 psi/175 bar.
  - Be sure all hose connections are tight.
  - The hydraulic circuit control valve must be in the **OFF** position when coupling or uncoupling the tool. Wipe all couplers clean before connecting. Failure to do so may result in damage to the quick couplers and cause overheating. Use only lint-free cloths.
  - Do not operate the tool at oil temperatures above 140 °F/60 °C. Operation at higher oil temperatures can cause operator discomfort and may cause damage to the tool.
  - Do not operate a damaged, improperly adjusted or incompletely assembled tool.
  - To avoid personal injury or equipment damage, all tool repair, maintenance and service must only be performed by authorized and properly trained personnel.
  - Do not exceed the rated limits of the tool or use the tool for applications beyond its design capacity.
  - Always keep critical tool markings, such as labels and warning stickers, legible.
  - Always replace parts with replacement parts recommended by STANLEY.
  - Check fastener tightness often and before each use daily.
  - **WARNING:** Some dust created by power sanding, sawing, grinding, drilling, and other construction activities contains chemicals known to the State of California to cause cancer, birth defects or other reproductive harm. Some examples of these chemicals are:
    - Lead from lead-based paints,
    - crystalline silica from bricks and cement and other masonry products, and
    - arsenic and chromium from chemically-treated lumber.

Your risk from these exposures varies, depending on how often you do this type of work. To reduce your exposure to these chemicals: work in a well ventilated area, and work with approved safety equipment, such as those dust masks that are specially designed to filter out microscopic particles.

Protect yourself and those around you. Research and understand the materials you are cutting. Follow correct safety procedures and comply with all applicable national, state or provisional health and safety regulations relating to them, including, if appropriate arranging for the safe disposal of the materials by a qualified person.

# TOOL STICKERS & TAGS



28409  
Composite Sticker



11207  
Circuit Type D



11206  
Circuit Type C

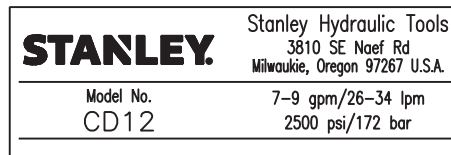

76483  
Name Tag Sticker

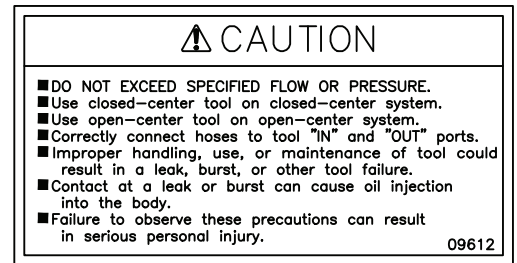

09612  
Caution Sticker

**NOTE:**  
THE INFORMATION LISTED ON THE STICKERS SHOWN, MUST BE LEGIBLE AT ALL TIMES.  
REPLACE DECALS IF THEY BECOME WORN OR DAMAGED. REPLACEMENTS ARE AVAILABLE FROM YOUR LOCAL STANLEY DISTRIBUTOR.

The safety tag (P/N 15875) at right is attached to the tool when shipped from the factory. Read and understand the safety instructions listed on this tag before removal. We suggest you retain this tag and attach it to the tool when not in use.

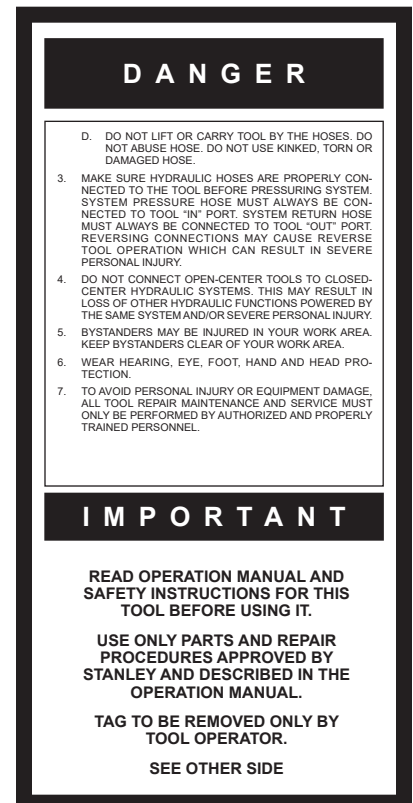
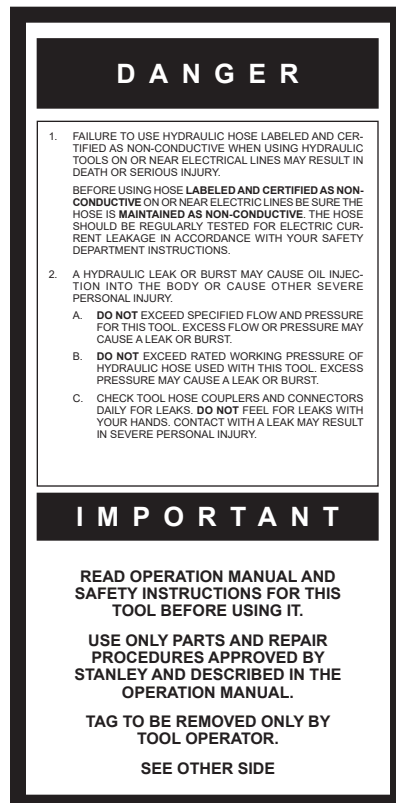

SAFETY TAG P/N 15875 (Shown smaller than actual size)

# HOSE TYPES

The rated working pressure of the hydraulic hose must be equal to or higher than the relief valve setting on the hydraulic system. There are three types of hydraulic hose that meet this requirement and are authorized for use with STANLEY hydraulic tools. They are:

**Certified non-conductive** — constructed of thermoplastic or synthetic rubber inner tube, synthetic fiber braid reinforcement, and weather resistant thermoplastic or synthetic rubber cover. *Hose labeled **certified non-conductive** is the only hose authorized for use near electrical conductors.*

**Wire-braided** (conductive) — constructed of synthetic rubber inner tube, single or double wire braid reinforcement, and weather resistant synthetic rubber cover. *This hose is **conductive** and must never be used near electrical conductors.*

**Fabric-braided** (not certified or labeled non-conductive) — constructed of thermoplastic or synthetic rubber inner tube, synthetic fiber braid reinforcement, and weather resistant thermoplastic or synthetic rubber cover. *This hose is **not certified non-conductive** and must never be used near electrical conductors.*

## HOSE SAFETY TAGS

To help ensure your safety, the following DANGER tags are attached to all hose purchased from STANLEY. DO NOT REMOVE THESE TAGS.

If the information on a tag is illegible because of wear or damage, replace the tag immediately. A new tag may be obtained from your STANLEY Distributor.

### THE TAG SHOWN BELOW IS ATTACHED TO “CERTIFIED NON-CONDUCTIVE” HOSE

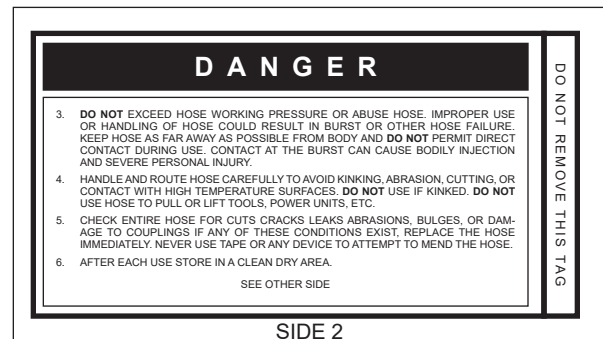
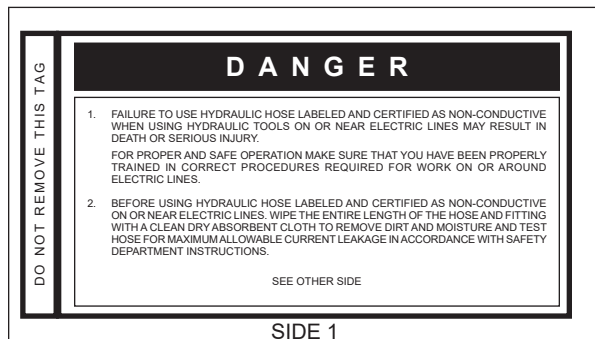

(Shown smaller than actual size)

### THE TAG SHOWN BELOW IS ATTACHED TO “CONDUCTIVE” HOSE.

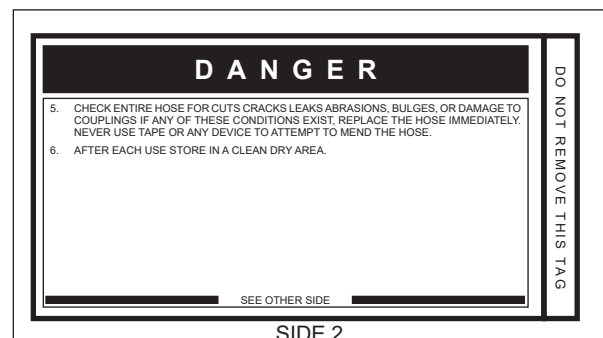
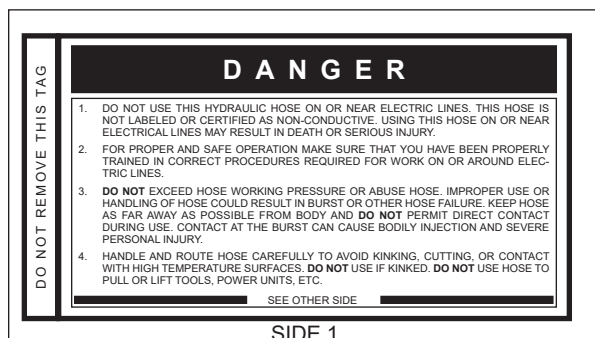

(Shown smaller than actual size)

# HOSE RECOMMENDATIONS

## Tool to Hydraulic Circuit Hose Recommendations

The chart to the right shows recommended minimum hose diameters for various hose lengths based on gallons per minute (GPM)/liters per minute (LPM). These recommendations are intended to keep return line pressure (back pressure) to a minimum acceptable level to ensure maximum tool performance.

This chart is intended to be used for hydraulic tool applications only based on STANLEY tool operating requirements and should not be used for any other applications.

All hydraulic hose must have at least a rated minimum working pressure equal to the maximum hydraulic system relief valve setting.

**All hydraulic hose must meet or exceed specifications as set forth by SAE J517.**

Oil Flow		Hose Lengths		Inside Diameter		USE (Press/Return)	Min. Working Pressure	
GPM	LPM	FEET	METERS	INCH	MM		PSI	BAR
<b>Certified Non-Conductive Hose - Fiber Braid - for Utility Bucket Trucks</b>								
4-9	15-34	up to 10	up to 3	3/8	10	Both	2250	155
<b>Conductive Hose - Wire Braid or Fiber Braid - DO NOT USE NEAR ELECTRICAL CONDUCTORS</b>								
4-6	15-23	up to 25	up to 7.5	3/8	10	Both	2500	175
4-6	15-23	26-100	7.5-30	1/2	13	Both	2500	175
5-10.5	19-40	up to 50	up to 15	1/2	13	Both	2500	175
5-10.5	19-40	51-100	15-30	5/8	16	Both	2500	175
5-10.5	19-40	100-300	30-90	5/8	16	Pressure	2500	175
10-13	38-49	up to 50	up to 15	3/4	19	Return	2500	175
10-13	38-49	51-100	15-30	5/8	16	Both	2500	175
10-13	38-49	100-200	30-60	3/4	19	Pressure	2500	175
13-16	49-60	up to 25	up to 8	1	25.4	Return	2500	175
13-16	49-60	26-100	8-30	5/8	16	Pressure	2500	175
				3/4	19	Return	2500	175
				3/4	19	Pressure	2500	175
				1	25.4	Return	2500	175

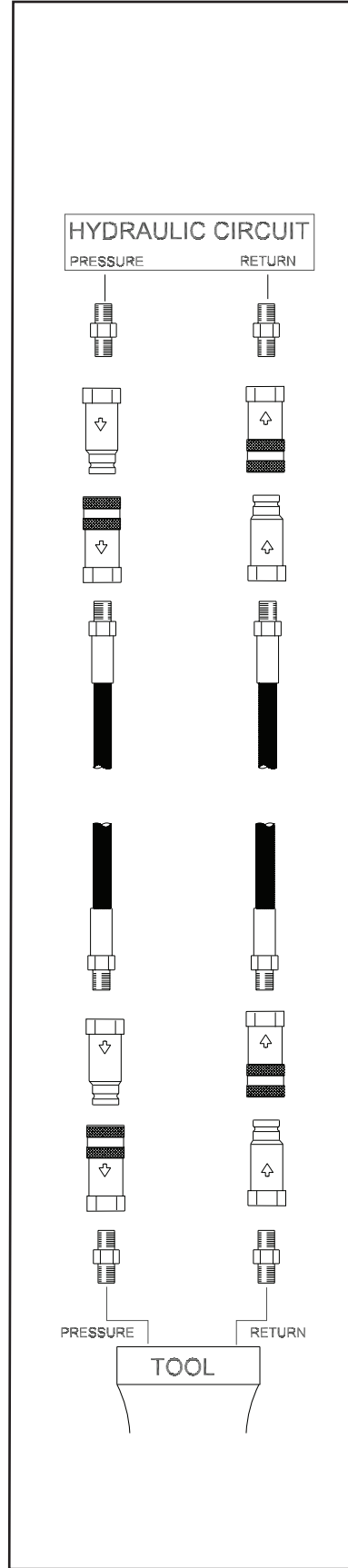

Figure 1. Typical Hose Connections







# HTMA / EHTMA REQUIREMENTS

## HTMA / EHTMA REQUIREMENTS

### TOOL TYPE

HTMA HYDRAULIC SYSTEM REQUIREMENTS	TYPE I	TYPE II	TYPE RR	TYPE III
Flow range	4-6 GPM (15-23 LPM)	7-9 GPM (26-34 LPM)	9-10.5 GPM (34-40 LPM)	11-13 GPM (42-49 LPM)
Nominal operating pressure (At the power supply outlet)	1500 psi (103 bar)	1500 psi (103 bar)	1500 psi (103 bar)	1500 psi (103 bar)
System relief valve setting (At the power supply outlet)	2100-2250 psi (145-155 bar)	2100-2250 psi (145-155 bar)	2200-2300 psi (152-159 bar)	2100-2250 psi (145-155 bar)
Maximum back pressure (At tool end of the return hose)	250 psi (17 bar)	250 psi (17 bar)	250 psi (17 bar)	250 psi (17 bar)
Measured at a max fluid viscosity of: (At minimum operating temperature)	400 ssu* (82 centistokes)	400 ssu* (82 centistokes)	400 ssu* (82 centistokes)	400 ssu* (82 centistokes)
Temperature: Sufficient heat rejection capacity to limit maximum fluid temperature to: (At maximum expected ambient temperature)	140° F (60° C)	140° F (60° C)	140° F (60° C)	140° F (60° C)
Minimum cooling capacity at a temperature difference of between ambient and fluid temps	3 hp (2.24 kW) 40° F (22° C)	5 hp (3.73 kW) 40° F (22° C)	6 hp (5.22 kW) 40° F (22° C)	7 hp (4.47 kW) 40° F (22° C)
<b>Note:</b> Do not operate the tool at oil temperatures above 140° F (60° C). Operation at higher temperatures can cause operator discomfort at the tool.				
Filter minimum full-flow filtration Sized for flow of at least: (For cold temp startup and maximum dirt-holding capacity)	25 microns 30 GPM (114 LPM)	25 microns 30 GPM (114 LPM)	25 microns 30 GPM (114 LPM)	25 microns 30 GPM (114 LPM)
Hydraulic fluid, petroleum based (premium grade, anti- wear, non-conductive) Viscosity (at minimum and maximum operating temps)	100-400 ssu (20-82 centistokes)	100-400 ssu (20-82 centistokes)	100-400 ssu (20-82 centistokes)	100-400 ssu (20-82 centistokes)
<b>Note:</b> When choosing hydraulic fluid, the expected oil temperature extremes that will be experienced in service determine the most suitable temperature viscosity characteristics. Hydraulic fluids with a viscosity index over 140 will meet the requirements over a wide range of operating temperatures.				
*SSU = Saybolt Seconds Universal				

### CLASSIFICATION

EHTMA HYDRAULIC SYSTEM REQUIREMENTS					
Flow range	3.5-4.3 GPM (13.5-16.5 LPM)	4.7-5.8 GPM (18-22 LPM)	7.1-8.7 GPM (27-33 LPM)	9.5-11.6 GPM (36-44 LPM)	11.8-14.5 GPM (45-55 LPM)
Nominal operating pressure (At the power supply outlet)	1870 psi (129 bar)	1500 psi (103 bar)	1500 psi (103 bar)	1500 psi (103 bar)	1500 psi (103 bar)
System relief valve setting (At the power supply outlet)	2495 psi (172 bar)	2000 psi (138 bar)	2000 psi (138 bar)	2000 psi (138 bar)	2000 psi (138 bar)

**Note:** These are general hydraulic system requirements. See tool specification page for tool specific requirements.

# OPERATION

## GENERAL OPERATION

Tools included are for mounting and dismounting:

- Single-head wrench SW 24
- Single-head wrench SW 32
- Single-head wrench SW 41
- Hex wrench SW 5

## DRILL BIT INSTALLATION

### **WARNING**

Before changing the drill bit, ensure the tool is disconnected from the hydraulic power source, to avoid unintentional operation of the tool and injury.

Use one SW24 or SW41 single-head wrench and one SW 32 single-head wrench to unscrew the drill bit.

## DIMENSION OF THE DRILL BIT

Drill head thread: male 1 – 1/4 in. UNC and female R 1/2 in.

Which drill bit at which speed?

	Gear #1	Gear #2	Gear #3
Speed (1/min)	610	1440	2880
Drill bit dia. (mm)	100–162	40–100	20–40
Cutting speed (m/s)	3.2–5.6	3.2–7.2	3.2–6.4

## CHECK THE POWER SOURCE

1. Using a calibrated flowmeter and pressure gauge, ensure the hydraulic power source develops a flow of 7–9 GPM/26–34 LPM at 950–2000 psi/66–138 bar.
2. Ensure the hydraulic power source is equipped with a relief valve, set to open at 2100–2250 psi/145–155 bar.
3. Check that the hydraulic circuit matches the tool for open-center (OC) operation.

## CHECK THE TOOL

1. Ensure all tool accessories are correctly installed. Failure to install tool accessories properly can result in damage to the tool or personal injury.
2. Check the equipment for signs of oil leaks. If leaks are observed, do not use the tool.
3. Check fasteners for tightness.

4. Check the tool and hydraulic system for proper operation and performance.

## CONNECT HOSES

1. Wipe all hose couplers with a clean, lint-free cloth, before making connections.
2. Connect the hoses from the hydraulic power source to the tool fittings. Connect the return hose first and disconnect it last to reduce trapped pressure in the tool.

**Note: If uncoupled hoses are left in the sun, pressure increase within the hoses can make them difficult to connect. When ever possible, connect the free ends of hoses together.**

3. Observe the flow indicators stamped on the hose couplers to ensure that the flow is in the proper direction. The female coupler on the drill is the inlet coupler.
4. Cycle the control valve momentarily. If the drill does not operate, the hoses may be reversed. Verify correct connection of the hoses before continuing.

## USING CD12 WITH ANCHOR STAND

The anchor stand may be used with a vacuum pump for vacuum hold down, or with a concrete anchor screw to hold the stand in place while drilling. The standard arrangement of the anchor stand is for use with a vacuum pump.

### **CAUTION**

Use of vacuum to hold the anchor stand on non-horizontal surfaces is not recommended. Loss of vacuum will allow the stand to slip or fall. The result may be personal injury or damage to the drill.

The carriage feed handle may be installed on either end of the pinion gear spindle. Align the cross-screw in the handle, with the slot in the spindle. Push the handle on until the spring detent in the handle snaps into the groove on the spindle.

## ATTACHING THE CORE DRILL TO THE ANCHOR STAND

1. Back out the drill mount locking screw, located in the carriage. Slide the dovetail block, attached to the core drill, into the carriage.
2. Tighten the drill mount locking screw into the dovetail

# OPERATION

block. The tip of the locking screw engages a hole in the dovetail block.

## USING THE ANCHOR STAND WITH A VACUUM PUMP

1. Connect the vacuum pump to the fitting on the base of the anchor stand.
2. Screw the leveling screws up to the underside of the base to allow the base gasket to compress when vacuum is created.
3. Make sure that the base gasket is in good condition to hold vacuum.
4. Position the anchor stand so that the drill and bit are aligned where the hole is to be drilled.
5. For a good seal, ensure the surface is free of debris.
6. Turn on the vacuum pump.
7. To reposition the anchor stand, as required to accurately place the drill bit, press the vacuum release button and move the anchor stand. Release the button to re-establish vacuum.
8. Adjust the leveling screws so they contact the drilling surface. This provides stable footing for the stand.
9. Tighten the jam nuts to lock the leveling screws.

## USING THE ANCHOR STAND WITH AN ANCHOR SCREW

1. Remove the vacuum handle and gasket from the base. The screw that holds the vacuum handle in place is located on the underside of the base.
2. Remove the base gasket from the base.
3. Screw the leveling screws up to the underside of the base.
4. Place the anchor stand and position the drill bit.
5. With a marking pen through the slot in the base, mark a line on the surface, along which to place the screw anchor.
6. Set the anchor stand aside. Drill and set the screw anchor. Place the anchor stand over the screw anchor and put the anchor screw through the slot in the base. Tighten. Ensure the drill bit is positioned.
7. Turn the leveling screws so they contact the drilling surface. Tighten the jam nuts to lock the leveling screws.
8. Tighten the anchor screw to hold the anchor stand in position.
9. The “Bulls Eye” level on the drill carriage is used

for indicating level when drilling into a horizontal surface. Use the leveling screws to adjust level.

10. A socket head capscrew goes through the bottom of the mast and into the base. This screw holds the mast square to the base. To drill an angled hole, remove this screw.
11. To adjust the mast to an angle (up to 45 degrees), loosen the clamping screw located in the sliding handle, on the back of the mast. Move the mast to the desired angle and tighten the screw.

## NOTICE

Manually screw the corresponding drill bit from below onto the drill bit adapter. Manual tightening is sufficient because the drill bit will automatically tighten further during the drilling operation.

12. Connect the core drill to a water supply. The maximum allowed water pressure is 60 psi/4 bar.

## CAUTION

Monitor the water supply to ensure that sufficient water is applied to the cut surface, to avoid unnecessary wear of drilling equipment.

13. Connect the core drill to a hydraulic power supply. Note the correct connections for the flow of fluid to the core drill.

## DRILLING A HOLE

## CAUTION

When drilling into a structure that may contain electrical wiring, be sure to know the location of the wiring and do not drill into it. The housing can carry electrical current from live electrical wires. Accidentally drilling into them can result in injury or death.

1. Open the water supply valve and adjust the water flow as required. It may be necessary to adjust the water as the drill bit advances in the hole.
2. Start the core drill by moving the drill valve lever to “ON”.

# OPERATION

3. While holding the feed handle, pull the carriage lock knob out to release the carriage from the mast.
4. Feed the drill to the work face and begin drilling. Start slowly to allow the drill bit to create a full seat in the hole.
5. When drilling is finished, return the carriage to the top of the mast and lock the carriage in place.
6. Turn off the core drill.
7. Turn off the water.
8. Turn off the hydraulic system.
9. Remove the drill bit. It may be necessary to use wrenches to loosen and remove the drill bit.
10. Loosen and back out the drill mount locking screw. Remove the core drill and dovetail block from the carriage.
11. Release the vacuum or remove the anchor screw to move the drill stand.

## ADJUSTING THE GUIDE BUSHINGS

1. Loosen the pinch screws that lock the bushing caps. Tighten or loosen the bushing caps as necessary to remove play between the carriage and the mast.
2. Tighten the pinch screws to lock the bushing caps.

To replace the guide bushings:

1. Remove the top carry handle and stop plate.
2. Pull the carriage lock knob to release the carriage. Pull the carriage up and off the mast.
3. Remove the guide bushings from the carriage.
4. Loosen the pinch screws that lock the bushing caps and back out the bushing caps.
5. Install the new guide bushings.
6. Place the carriage on the mast while making sure the guide bushings align with the grooves in the mast.
7. Slide the carriage onto the mast until the carriage lock knob engages the mast.
8. Tighten the bushing caps to remove all carriage play. Tighten the pinch screws to lock the bushing caps. Replace the stop plate and the top carry handle

## COLD WEATHER OPERATION

Before using CD12 in cold weather, preheat the hydraulic fluid with the hydraulic power supply set at a low speed. The oil should be at, or above, 50 °F (10 °C) with a

viscosity of 400 SSU (82 cs), before operating the tool. Damage to the hydraulic system or drill can result from use with fluid that is too viscous or too thick.

## STORAGE

Replace any damaged or missing safety decals, labels and tags before storing the tool. Otherwise, the tool might be improperly used by someone who is not familiar with the safety requirements.

Drain all water from the core drill.

Store the tool in a clean, dry and safe place.

## MAINTENANCE

Good maintenance practice keeps the core drill on the job and increases its service life.

The most important maintenance practice is to keep the hydraulic fluid clean at all times. Contaminated fluid causes rapid wear and/or failure of internal parts.

Follow the recommendations contained in "HTMA / EHTMA REQUIREMENTS" on page 9, to ensure peak performance from the tool.

Do not disassemble the tool until you know whether the problem is in the hydraulic power supply, the gearbox module, or the power and control (rear) module. Then only disassemble the tool as necessary to repair as required. **KEEP CONTAMINANTS SUCH AS DIRT AND GRIT AWAY FROM INTERNAL PARTS AT ALL TIMES.**

Always determine and correct the cause of the problem prior to reassembly. Further wear and tool failure can result if the original cause is not corrected.

# TOOL PROTECTION & CARE

## NOTICE

In addition to the safety precautions found in this manual, observe the following for equipment protection and care.

- Make sure all couplers are wiped clean before connection.
- The hydraulic circuit control valve must be in the “OFF” position when coupling or uncoupling hydraulic tools. Failure to do so may result in damage to the quick couplers and cause overheating of the hydraulic system.
- Always store the tool in a clean, dry space, safe from damage or pilferage.
- Make sure the circuit PRESSURE hose (with male quick disconnect) is connected to the **IN** port. The circuit RETURN hose (with female quick disconnect) is connected to the opposite port. Do not reverse circuit flow. This can cause damage to internal seals.
- Always replace hoses, couplings and other parts with replacement parts recommended by STANLEY. Supply hoses must have a minimum working pressure rating of 2500 psi/172 bar.
- Do not exceed the rated flow. Rapid failure of internal seals may result. See “SPECIFICATIONS” on page 16 for correct flow rate.
- Always keep critical tool markings, such as warning stickers and tags, legible.
- Tool repair should be performed by experienced and trained personnel only.
- Make certain that the recommended relief valves are installed in the pressure side of the system.
- Do not use the tool for applications for which it was not intended.

# TROUBLESHOOTING

When diagnosing faults in operation of the tool always check that the hydraulic power source is supplying the correct hydraulic flow and pressure, as listed in the table. Use a flowmeter known to be accurate. Check the flow with the hydraulic oil temperature at least 80 °F/27 °C.

Problem	Cause	Solution
Tool will not start	Power not being supplied.	Make sure the hoses are connected and the couplers are tight. Turn the hydraulic system control valve <b>ON</b> .
	Defective quick-disconnect.	Check each disconnect separately. Replace as necessary.
	Jammed motor.	See your authorized dealer for service.
Low drilling torque.	Incorrect hydraulic flow.	Check that the hydraulic power source is producing 7-9 GPM/26-34 LPM at 950-2000 psi/66-138 bar.
	Defective quick-disconnect.	Check each disconnect separately.
	Hydraulic circuit relief set too low.	Set relief valve at 2100 psi/145 bar.
	Fluid restriction in hose or valve. Excess back-pressure.	Locate and remove obstruction.
	Hoses too restrictive.	Fluid not warmed up. Preheat system.
	Hydraulic fluid is too thick.	Hoses too long for hose ID. Use shorter hose. Use larger ID hose.
	Too low slip clutch torque.	Inspect and replace slip clutch washers if necessary. Set torque to 45 ± 1.5 Nm/ 33 ± 1 ft-lb. See your authorized service dealer for repair.
	Over-feeding the drill.	Do not overload drill to avoid wear of slip clutch.
Tool runs too fast.	Incorrect hydraulic flow.	Check that hydraulic power source is not producing over 8 GPM/30 LPM at 950-2000 psi/66-138 bar.
Fluid leak between motor and valve housing.	Motor capscrews loose.	Tighten to recommended torque (10 Nm = 7.5 ft-lb).
	Motor O-rings worn.	See your authorized dealer for repair.
	Motor cap/main housing damaged.	See your authorized dealer for repair.
Fluid leaks at control valve.	Damaged O-rings.	See your authorized dealer for repair.
	Wrong hydraulic fluid. Circuit too hot.	See Operation section for correct fluid/circuit specifications.
	Hydraulic pressure and return hoses reversed.	Correct hose connections.

# TROUBLESHOOTING

Problem	Cause	Solution
Fluid gets too hot.	Circuit relief set too low.	Adjust relief valve to 2100-2250/145-155 bar.
	Too much fluid going through tool.	Adjust flow for 6 GPM/23 LPM maximum.
	Circuit has contaminants that have caused wear and high heat generation.	Replace worn pump and valves. Install a large clean filter and keep the fluid clean.
Gear shift knob turns hard.	Oil leak at motor shaft seal into gearbox causes high pressure in gearbox.	See your authorized service dealer for repair.
No gearshift function.	Shifter pin worn or broken.	See your authorized service dealer for repair.
Water leaking out of shaft.	Output shaft seals worn.	See your authorized service dealer for repair.
	Water pressure too high. Seal damaged.	Maximum water pressure 60 psi/4 bar. Replace seals.

## ANCHOR STAND TROUBLESHOOTING

Symptom	Cause	Solution
The Anchor Stand will not hold a vacuum.	Debris under the base gasket is preventing a good seal.	Clean the surface on which the gasket must seal.
	Debris between the base gasket and the base.	Clean the base surface.
	The gasket is worn out or damaged.	Replace.
	The slot gasket will not seal.	Inspect. Clean or replace.
	The vacuum release button is leaking.	Inspect. Clean or replace.
	Leveling screw(s) set too far down.	Retract the screws to allow the base gasket to seal.
	Vacuum leak in the line between the base and vacuum pump.	Inspect and seal as required.
Excessive play between the carriage and mast.	Normal wear of the guide bushings.	Adjust the guide bushings.
Excessive play between the mast and the base.	Pivot block capscrews are loose.	Tighten the capscrews to just snug to remove play.

# SPECIFICATIONS

System Type.....	HTMA Type II OC
Flow Range .....	7–9 GPM/26–34 LPM
Optimum Flow .....	8 GPM/30 LPM
Pressure (maximum) .....	2000 psi/138 bar
Drill Bit Connection .....	1-1/4 in. UNC Male/1/2 inch Female
Free Speed .....	1st Gear 610 rpm, 2nd Gear 1440 rpm, 3rd Gear 2880 rpm
Porting Size .....	-8 SAE O-ring
Weight .....	18.7 lbs/8.5 kg
Length.....	19.3 in./490 mm

## ACCESSORIES

Anchor Stand, 12 in. ....	62378
7/8 in. Core Bit with Crown .....	41241
1 in. Core Bit with Crown .....	41242
1-1/4 in. Core Bit with Crown .....	41243
2 in. Core Bit Segmented .....	41244
3 in. Core Bit Segmented .....	41245
4 in. Core Bit Segmented .....	41246
6 in. Core Bit Segmented .....	41247
Vacuum Pump Accessory .....	44957
Vacuum Pump Instruction.....	44958

## SERVICE PARTS

Filter Element – Vacuum Pump .....	44969
Muffler Element – Vacuum Pump .....	44971
Seal Kit – CD10/CD12.....	45110



# CD12 PARTS ILLUSTRATION

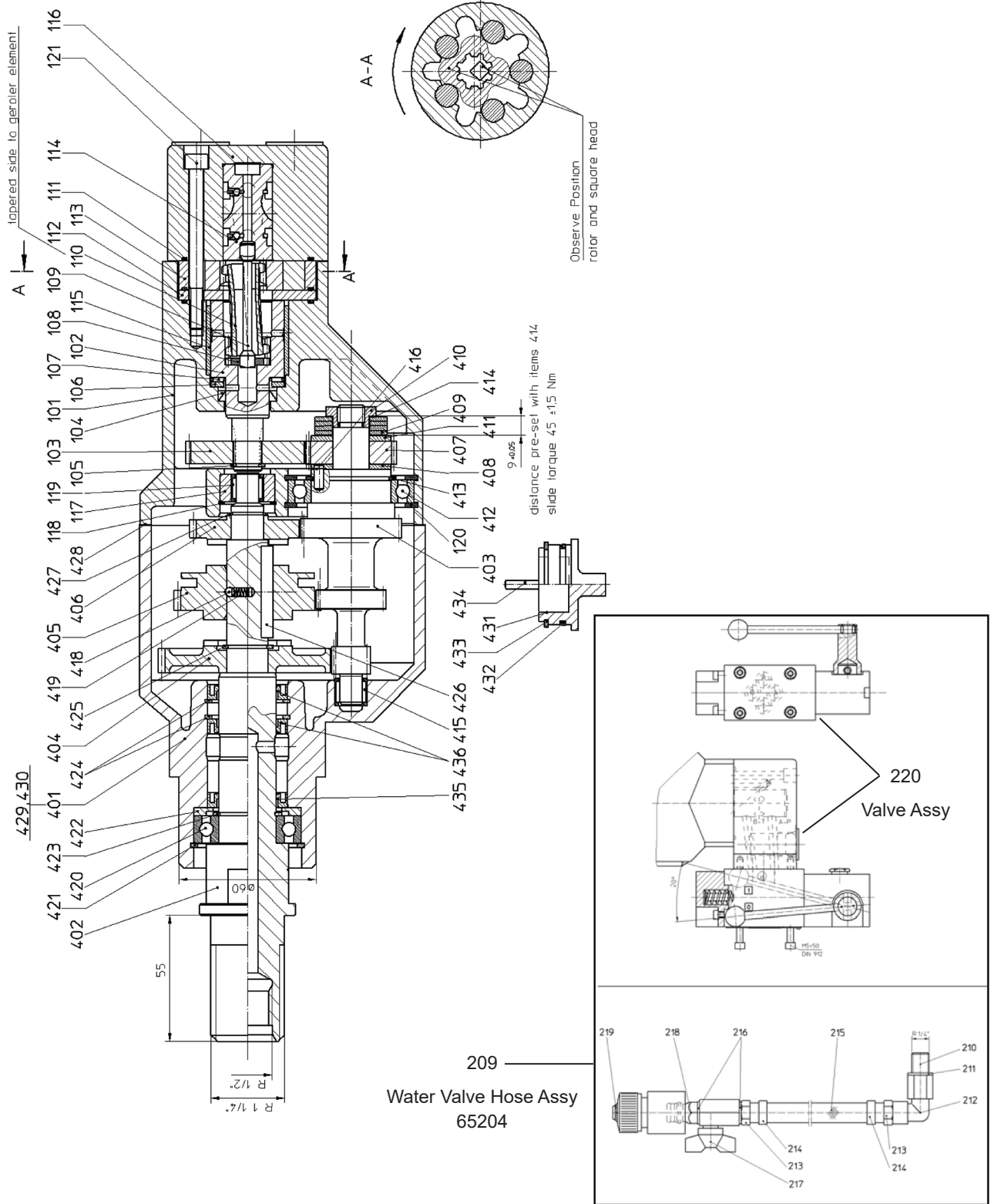

# CD12 PARTS LIST

ITEM	PART NO.	QTY	DESCRIPTION
AY1	65311	1	MOTORASSEMBLY(INCLITEMS 101 THROUGH 121)
101	65207	1	MOTOR HOUSING
102	41254	1	OUTPUT SHAFT
103	41255	1	SPUR GEAR
104	41256	1	SHAFT SEALING
105	41257	1	SNAP RING
106	41258	1	THRUST WASHER
107	41259	1	THRUST BEARING
108	41260	1	SHAFT SPACER
109	65208	1	SPOOL DRIVE
110	65209	1	DRIVE
111	41263	3	O-RING*
112	41264	1	SPACER PLATE
113	65211	1	GEROLER ASSEMBLY
114	41266	1	SPOOL
115	41267	1	BEARING
116	65212	1	COVER
117	41624	1	BEARING RING
118	41268	1	SNAP RING
119	41269	1	NEEDLE BEARING
120	41270	1	SNAP RING
121	65213	5	HSH CAPSCREW
AY2	41250	1	THREE SPEED GEARBOX (INCL ITEMS 401 THROUGH 436 & 210 THROUGH 219)
401	41271	1	BEARING HOUSING
402	41272	1	OUTPUT SHAFT
404	41273	1	SPUR GEAR
405	41274	1	NOTCHED WHEEL
406	41275	1	SPUR GEAR
415	41276	1	NEEDLE BEARING
418	41277	1	BALL
419	41278	1	COMPRESSION SPRING
420	41279	1	GROOVED BALL BEARING
421	41280	1	SNAP RING
422	41281	1	WASHER
423	41284	1	SNAP RING
424	41286	2	SNAP RING
425	41287	1	SNAP RING
426	41298	1	FEATHER KEY
427	41348	1	SNAP RING
433	41373	1	SNAP RING
435	41376	2	RADIAL SHAFT SEALING
436	41377	1	RADIAL SHAFT SEALING

ITEM	PART NO.	QTY	DESCRIPTION
AY3	41379	1	COUNTERSHAFT ASSEMBLY (INCLITEMS 403 THROUGH 417)
403	41380	1	GEAR SHAFT
407	41381	1	SPUR GEAR
408	41382	1	WASHER
409	41383	4	BELLEVILLE SPRING
410	41384	1	NUT
411	41385	1	COMPRESSION RING
412	41386	1	GROOVED BALL BEARING
413	41387	1	SNAP RING
414	41388	2	SHIM
417	41389	1	SHIM
416	41390	1	DOWEL PIN*
428	41391	1	SEAL
429	41392	4	HSH CAPSCREW, M5 X 50
430	52661	2	DOWEL PIN
209	65204	1	WATER VALVE HOSE ASSY (INCLITEMS 210 THROUGH 219)
210	41587	1	CONNECTING PIECE
211	41396	1	GASKET*
212	65204	1	ELBOW (PART OF ITEM 209)
213	65204	2	HOSE CONNECTOR (PART OF ITEM 209)
214	65204	2	CLAMP (PART OF ITEM 209)
215	65204	1	HOSE (PART OF ITEM 209)
216	41396	2	GASKET
217	65206	1	STOPCOCK
218	41586	1	CONNECTING PIECE
219	41588	1	WATER-STOP GARDENA 1/2 IN
220	65203	1	VALVE ASSY
221	03971	1	COUPLER SET (NOT SHOWN)
222	62377	1	DRILL MOTOR & ANCHOR STAND (NOT SHOWN)
223	01652	1	HOSE ASSY (NOT SHOWN)
224	62416	1	SPACER, 1 IN (CD12200 ONLY, NOT SHOWN)
<b>TOOL DECALS</b>			
	11206	1	CIRCUIT TYPE C
	11207	1	CIRCUIT TYPE D
	28409	1	COMPOSITE
	76483		CD12 NAME/GPM
	09612		CAUTION
<b>SEAL KIT</b>			
SK	45110		SEAL KIT (* DENOTES PART IN SEAL KIT)

# CD12 ANCHOR STAND ILLUSTRATION

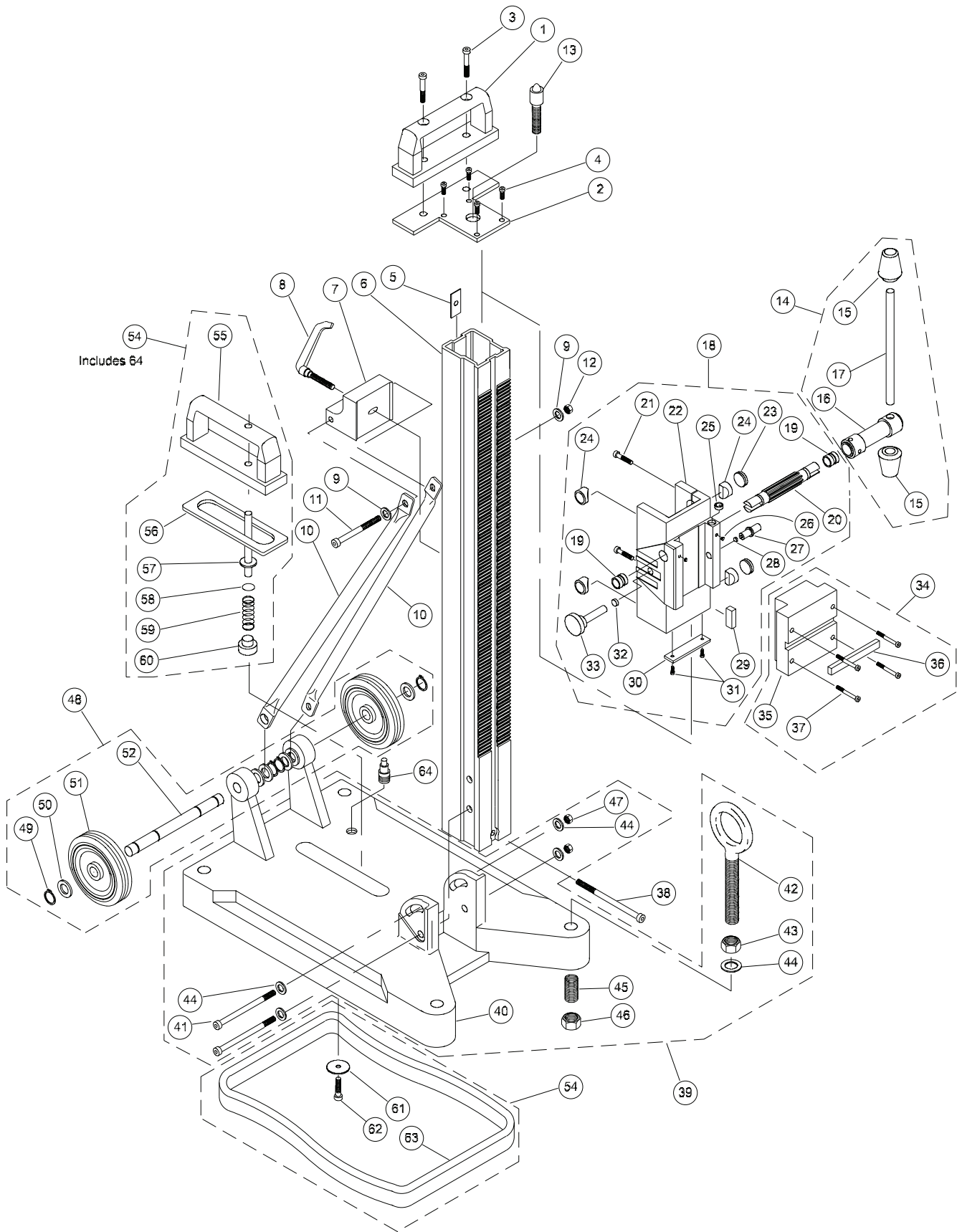

# CD12 ANCHOR STAND PARTS LIST

ITEM	PART NO.	QTY	DESCRIPTION
1	65214	1	HANDLE
2	65215	1	STOP PLATE
3	65216	2	HSH CAPSCREW
4	65217	4	HSFH SCREW
5	65218	1	CLAMP PLATE
6	65219	1	DRILL STAND COLUMN
7	65220	1	CLAMP BLOCK
8	65221	1	CLAMP LEVER
9	65222	2	WASHER
10	65223	2	SUPPORT TUBE
11	65224	1	HSH CAPSCREW
12	65225	1	HEX NUT
13	65226	1	CENTERING SCREW
14	65227	1	HANDLE ASSY (INCL ITEMS 15 THROUGH 17)
18	65228	1	CARRIAGE ASSY (INCL ITEMS 19–33)
19	65229	2	THREADING BUSHING
20	65230	1	GEARED SPINDLE
21	65231	2	HSH CAPSCREW
22	65232	1	CARRIAGE
23	65233	2	GUIDE ADJUSTING SCREW
24	65234	4	CARRIAGE GUIDE
25	65235	1	BULLSEYE LEVEL
26	65236	2	PIN
27	65237	1	DRILL MOUNT LOCKING SCREW
28	65238	1	NIB
29	65239	1	SQUARE KEY
30	65240	1	STOP PLATE, MOTOR MOUNT
31	65241	2	HSFH SCREW
32	65242	1	CARRIAGE LOCK BUSHING
33	65243	1	CARRIAGE LOCK
34	65244	1	DOVETAIL MOTOR MTG BLOCK ASSY (INCL ITEMS 35–37)
35	65245	1	DOVETAIL MOTOR MTG BLOCK
36	65246	1	SQUARE KEY, LONG
37	65224	4	HSH CAPSCREW CD12100 ONLY
	60950	4	HSH CAPSCREW CD12200 ONLY
38	65247	1	HSH CAPSCREW
39	65248	1	BASE ASSY (INCL ITEMS 40–47)
40	65249	1	BASE
41	65251	2	HSH CAPSCREW
42	65252	2	EYE BOLT
43	65253	2	HEX NUT
44	65254	4	WASHER
45	65255	2	SLEEVE

ITEM	PART NO.	QTY	DESCRIPTION
46	65256	2	LEVELING LEG NUT
47	65257	2	HEX NUT
48	65258	1	WHEEL & AXLE ASSY (INCL ITEMS 49–52)
55	65259	1	VACUUM HANDLE
56	65260	1	VACUUM HANDLE GASKET
57	65261	1	VACUUM RELEASE BUTTON
58	65262	1	O-RING
59	65263	1	SPRING
60	65264	1	VACUUM VALVE SEAT
61	65265	1	WASHER
62	65266	1	HSH CAPSCREW
63	65267	1	BASE GASKET
64	65268	1	HOSE BARB







# **STANLEY®**

STANLEY Infrastructure  
6430 SE Lake Road  
Portland, Oregon 97222 USA  
(503) 659-5660 / Fax (503) 652-1780  
[www.stanleyinfrastructure.com](http://www.stanleyinfrastructure.com)