

2 MP Full Time Color Camera

User Manual

User Manual

Thank you for purchasing our product. If there are any questions, or requests, do not hesitate to contact the dealer.

This manual applies to the models below:

| Type | Model |
|-----------------|--------------------|
| Type I Camera | DS-2CE12DF3T-FS |
| | DS-2CE12DF8T-FSLN |
| Type II Camera | DS-2CE10DF3T-FS |
| | DS-2CE10DF8T-FSLN |
| | DS-2CE10DF3T-PFS |
| | DS-2CE10DF8T-PFSLN |
| Type III Camera | DS-2CE72DF3T-FS |
| | DS-2CE72DF8T-FSLN |
| Type IV Camera | DS-2CE70DF3T-MFS |
| | DS-2CE70DF8T-MFSLN |
| Type V Camera | DS-2CE70DF3T-PFS |
| | DS-2CE70DF8T-PFSLN |

This manual may contain several technical mistakes or printing errors, and the content is subject to change without notice. The updates will be added to the new version of this manual. We will readily improve or update the products or procedures described in the manual.

Regulatory Information

FCC Information

Please take attention that changes or modification not expressly approved by the party responsible for compliance could void the user's authority to operate the equipment.

FCC compliance: This equipment has been tested and found to comply with the limits for a Class A digital device, pursuant to part 15 of the FCC Rules. These limits are designed to provide reasonable protection against harmful interference when the equipment is operated in a commercial environment. This equipment generates, uses, and can radiate radio frequency energy and, if not installed and used in accordance with the instruction manual, may cause harmful interference to radio communications. Operation of this equipment in a residential area is likely to cause harmful interference in which case the user will be required to correct the interference at his own expense.

FCC Conditions

This device complies with part 15 of the FCC Rules. Operation is subject to the following two conditions:

1. This device may not cause harmful interference.
2. This device must accept any interference received, including interference that may cause undesired operation.

EU Conformity Statement



This product and - if applicable - the supplied accessories too are marked with "CE" and comply therefore with the applicable harmonized European standards listed under the Low Voltage Directive 2014/35/EU, the EMC Directive 2014/30/EU, the RoHS Directive 2011/65/EU.



2012/19/EU (WEEE directive): Products marked with this symbol cannot be disposed of as unsorted municipal waste in the European Union. For proper recycling, return this product to your local supplier upon the purchase of equivalent new

equipment, or dispose of it at designated collection points. For more information see: www.recyclethis.info.

2006/66/EC (battery directive): This product contains a battery that cannot be disposed of as unsorted municipal waste in the European Union. See the product documentation for specific battery information. The battery is marked with this symbol, which may

include lettering to indicate cadmium (Cd), lead (Pb), or mercury (Hg). For proper recycling, return the battery to your supplier or to a designated collection point. For more information, see: www.recyclethis.info.

Industry Canada ICES-003 Compliance

This device meets the CAN ICES-3 (A)/NMB-3(A) standards requirements.

Warning

This is a class A product. In a domestic environment this product may cause radio interference in which case the user may be required to take adequate measures.



Safety Instruction

These instructions are intended to ensure that user can use the product correctly to avoid danger or property loss.

The precaution measure is divided into “Warnings” and “Cautions”.

Warnings: Serious injury or death may occur if any of the warnings are neglected.

Cautions: Injury or equipment damage may occur if any of the cautions are neglected.

| | |
|---|--|
|  |  |
| Warnings Follow these safeguards to prevent serious injury or death. | Cautions Follow these precautions to prevent potential injury or material damage. |



Warnings

- In the use of the device, you must be in strict compliance with the electrical safety regulations of the nation and region.
- Input voltage should meet both the SELV (Safety Extra Low Voltage) and the Limited Power Source with 12 VDC according to the IEC60950-1 and IEC62368-1 standard. Refer to technical specifications for detailed information.
- Do not connect multiple devices to one power adapter to avoid over-heating or a fire hazard caused by overload.
- Make sure that the plug is firmly connected to the power socket.
- Make sure that the device is firmly fixed if wall mounting or ceiling mounting is adopted.
- If smoke, odor or noise rise from the device, turn off the power at once and unplug the power cord, and then contact the service center.
- Never attempt to disassemble the camera by unprofessional personal.



Cautions

- Do not drop the camera or subject it to physical shock.
- Do not touch sensor modules with fingers.
- Do not place the camera in extremely hot, cold (the operating temperature shall be -40°C to 60°C), dusty or damp locations, and do not expose it to high electromagnetic radiation.
- If cleaning is necessary, use clean cloth with a bit of ethanol and wipe it gently.
- Do not aim the camera at the sun or extra bright places.
- The sensor may be burned out by a laser beam, so when any laser equipment is in using, make sure that the surface of sensor will not be exposed to the laser beam.
- Do not expose the device to high electromagnetic radiation or extremely hot, cold, dusty or damp environment.
- To avoid heat accumulation, good ventilation is required for the operating environment.
- Keep the camera away from liquid while in use for non-water-proof device.
- While in delivery, the camera shall be packed in its original packing, or packing of the same texture.

- The power of pick-up should be under 12 V, 50 mA.
- DO NOT discard line-in conversion interface when insert pickups, and pay attention to the connection sequence, so as not to damage the pick-up.
- Line-in interface should assort with the conversion interface in the package, and pay attention to the connection sequence when connecting to a third party device.

Mark Description

Table 0-1 Mark Description

| Mark | Description |
|------|-------------|
| --- | DC Voltage |

1 Introduction

1.1 Product Features

The main features are as follows:

- High performance CMOS sensor
- OSD menu with configurable parameters
- 24-hour color image
- Smart light
- 3-axis adjustment
- High quality audio with audio over coaxial cable, built-in mic

1.2 Overview

1.2.1 Overview of Type I Camera

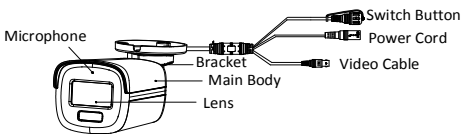

Figure 1-1 Overview of Type I Camera (DF3T series)

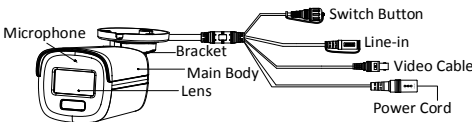

Figure 1-2 Overview of Type I Camera (DF8T series)

Notes:

- Line-in is for external pick-up. The cable is only available for DF8T series.
- Press and hold the switch button for 5 seconds to switch the video output. Four kinds of video outputs are available: TVI, AHD, CVI, and CVBS.

1.2.2 Overview of Type II Camera

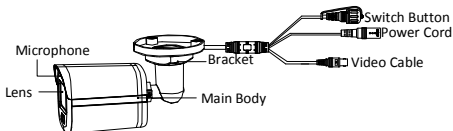

Figure 1-3 Overview of Type II Camera (DF3T series)

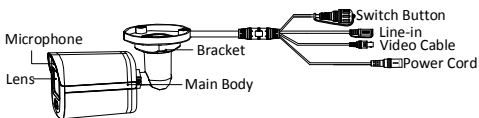

Figure 1-4 Overview of Type II Camera (DF8T series)

Notes:

- Line-in is for external pick-up. The cable is only available for DF8T series.
- Press and hold the switch button for 5 seconds to switch the video output. Four kinds of video outputs are available: TVI, AHD, CVI, and CVBS

1.2.3 Overview of Type III Camera

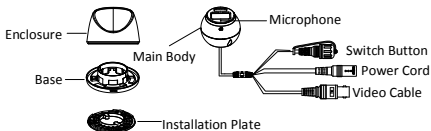

Figure 1-5 Overview of Type III Camera (DF3T series)

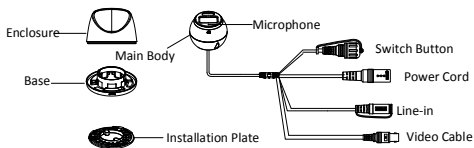

Figure 1-6 Overview of Type III Camera (DF8T series)

Notes:

- Line-in is for external pick-up. The cable is only available for DF8T series.
- Press and hold the switch button for 5 seconds to switch the video output. Four kinds of video outputs are available: TVI, AHD, CVI, and CVBS

1.2.4 Overview of Type IV Camera

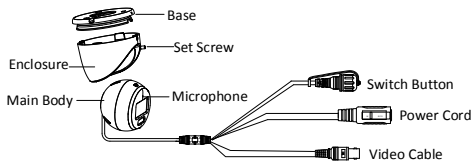

Figure 1-7 Overview of Type IV Camera (DF3T Series)

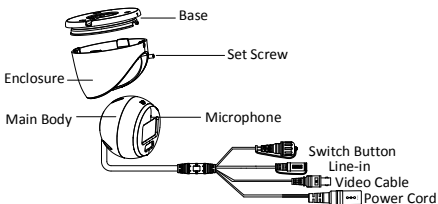

Figure 1-8 Overview of Type IV Camera (DF8T Series)

Notes:

- Line-in is for external pick-up. The cable is only available for DF8T series.

- Press and hold the switch button for 5 seconds to switch the video output. Four kinds of video outputs are available: TVI, AHD, CVI, and CVBS

1.2.5 Overview of Type V Camera

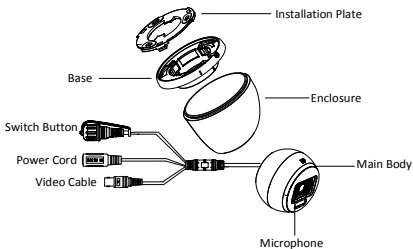

Figure 1-9 Overview of Type V Camera (DF3T Series)

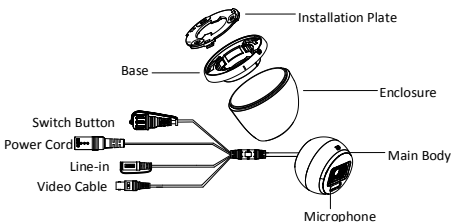

Figure 1-10 Overview of Type V Camera (DF8T Series)

Notes:

- Line-in is for external pick-up. The cable is only available for DF8T series.
- Press and hold the switch button for 5 seconds to switch the video output. Four kinds of video outputs are available: TVI, AHD, CVI, and CVBS

2 Installation

Before you start

- Make sure that the device in the package is in good condition and all the assembly parts are included.
- Make sure that all the related equipment is power-off during the installation.
- Check the specification of the products for the installation environment.
- Check whether the power supply is matched with your power output to avoid damage.
- Make sure the wall is strong enough to withstand three times the weight of the camera and the mount.
- If the product does not function properly, contact your dealer or the nearest service center. DO NOT disassemble the camera for repair or maintenance by yourself.

2.1 Installation of Type I and Type II Camera

Before you start:

The installation of type I and type II camera are similar. Following guide takes type I as example.

2.1.1 Ceiling/Wall Mounting without Junction Box

Steps:

1. Paste the drill template (supplied) to the installation location.

- (Optional) For cement ceiling, drill the screw holes with a 5.5 mm drill and insert the supplied wall plugs.
- (Optional) Drill the cable hole, when the cables are routed through the ceiling.
- Secure the camera to ceiling with three PA4 × 25 screws (supplied).

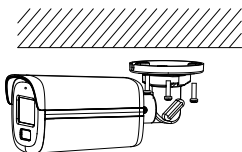

Figure 2-1 Secure the Camera to the Ceiling

- Connect the power cord and video cable.
- Power on the camera to adjust the view angle according to the figure below.

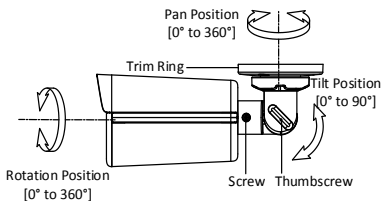

Figure 2-2 3-Axis Adjustment

2.1.2 Ceiling/Wall Mounting with Junction Box

Before you start:

- You need to purchase a junction box in advance.
 - Ceiling mounting and wall mounting are similar.
- Following steps take wall mounting as an example.

Steps:

- Paste the drill template for junction box to the installation location.
- (Optional) For cement wall, drill the screw holes with a 5.5 mm drill and insert the supplied wall plugs.
- (Optional) Drill the cable hole, when the cables are routed through the wall.
- Take apart the junction box.
- Fix the camera to the junction box cover with three PM4 × 10 screws.

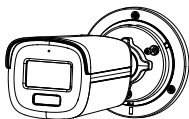

Figure 2-3 Fix the Camera to the Junction Box Cover

- Secure the junction box body on the wall with three PA4 × 25 screws (supplied).

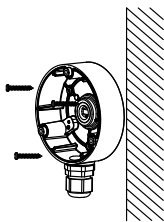

Figure 2-4 Secure the Junction Box on the Wall

7. Route the cables through the bottom cable hole or side cable hole of the junction box and connect the cables.
8. Fix the junction box cover on its body with three PM3 × 16 L6 screws.

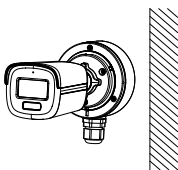

Figure 2-5 Fix the Cover to Its Body

9. Refer **Step 6** of **Section 2.1.1** to finish installation.

2.2 Installation of Type III, Type IV and Type V Camera

Before you start:

The installation of type III, type IV and type V camera are similar. Following pictures are only for reference. Take the actual object as standard.

2.2.1 Ceiling Mounting without Junction Box

Steps:

1. Paste the drill template (supplied) to the installation location.
2. (Optional) For cement ceiling, drill the screw holes with a 5.5 mm drill and insert the supplied wall plugs.
3. Install the camera to ceiling.
 - **For Type III and Type V camera:**
 - i. Secure the installation plate to the ceiling with three PA4 × 25 screws (supplied).
 - ii. Fit the camera onto the installation plate.
 - iii. Turn the camera as the figure below until it snaps into the installation plate.

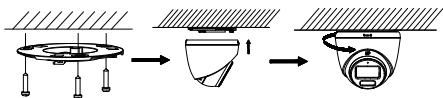

Figure 2-6 Install the Camera to Ceiling

- **For Type IV camera:**
 - i. Loosen the set screw.
 - ii. Rotate the camera to align the triangle mark with the screw hole, and disassemble the camera.

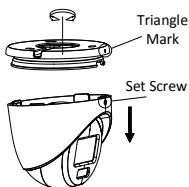

Figure 2-7 Disassemble the Camera

- iii. Secure the base to the ceiling with three PA4 × 25 screws (supplied).
- iv. Align the screw hole with the triangle mark to install the camera back to the base and secure it.

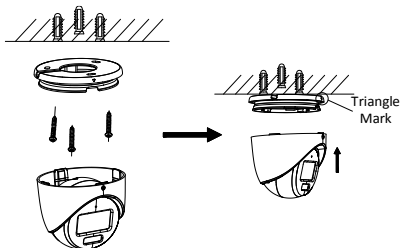

Figure 2-8 Install the Camera to Ceiling

4. Connect the power cord and video cable.
5. Power on the camera to adjust the view angle according to the figure below.

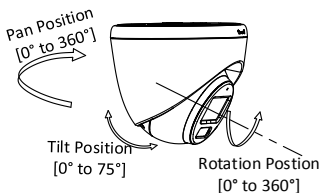

Figure 2-9 3-Axis Adjustment

- 1). Rotate the enclosure to adjust the pan position [0° to 360°].
- 2). Move the main body up and down to adjust the tilt position [0° to 75°].
- 3). Rotate the main body to adjust the rotation position [0° to 360°].

2.2.2 Ceiling Mounting with Junction Box

Before you start:

- You need to purchase a junction box in advance.
- Ceiling mounting with junction box and inclined ceiling mount are similar. Following steps take junction box as an example.

Steps:

1. Loosen screws to take apart the junction box.
2. Paste the drill template for junction box to the installation location.
3. (Optional) For cement ceiling, drill the screw holes with a 5.5 mm drill and insert the supplied wall plugs.
4. (Optional) Drill the cable hole, when the cables are routed through the ceiling.
5. Secure the junction box body on the ceiling with three or four PA4 × 25 screws according to the actual object.
6. Fix the camera to the junction box.

- **For Type III camera:**

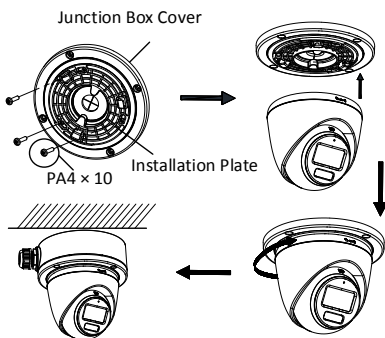

Figure 2-10 Fix the Camera to the Junction Box

- For Type IV and Type V camera:

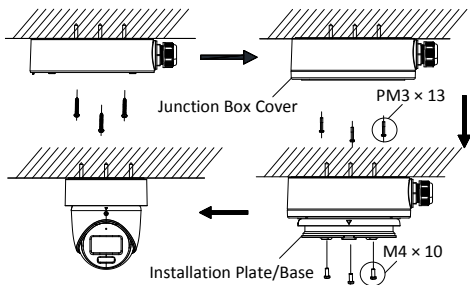

Figure 2-11 Fix the Camera to the Junction Box

7. Route the cables through the bottom cable hole or the side cable hole of the junction box.
8. Refer to **Step 5** of **Section 2.2.1** to adjust the angle and finish the installation.

2.2.3 Wall Mounting

Before you start:

You need to purchase a wall mount in advance.

Steps:

1. Drill Φ 10 mm screw holes in the wall where you want to install the wall mount.
2. Use four M6 expansion bolts to fix the wall mount onto the wall.

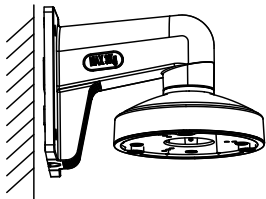

Figure 2-12 Fix the Wall Mount

3. Fix the base/installation plate to the wall mount.
 - For Type III and Type V camera:
 - i. Use three PM4 screws to fix the installation plate onto the wall mount.

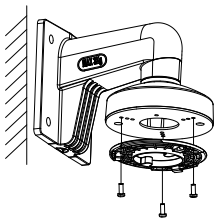

Figure 2-13 Fix the Installation Plate

● **For Type IV camera:**

- i. Refer to **Step 3** of Section **2.2.1** to disassemble the camera
- ii. Use M4 × 10 screws to fix the base onto the wall mount.

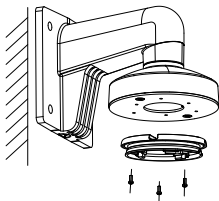

Figure 2-14 Fix the Base

4. Refer to **Steps 3 to 5** of Section **2.2.1** to finish installation.

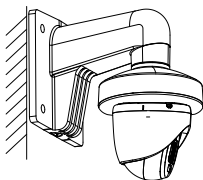

Figure 2-15 Finish Installation

3 Menu Description

Please follow the steps below to call the menu.

Note:

The actual display may vary with your camera model.

Steps:

1. Connect the camera with the TVI DVR and the monitor, as shown in figure 3-1.

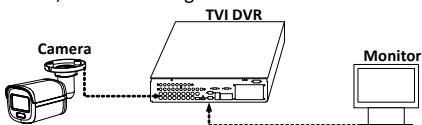



Figure 3-1 Connection

2. Power on the camera, TVI DVR, and monitor to view the image on the monitor.
3. Click PTZ Control to enter the PTZ Control interface.
4. Call the camera menu by clicking  button or calling preset No. 95.

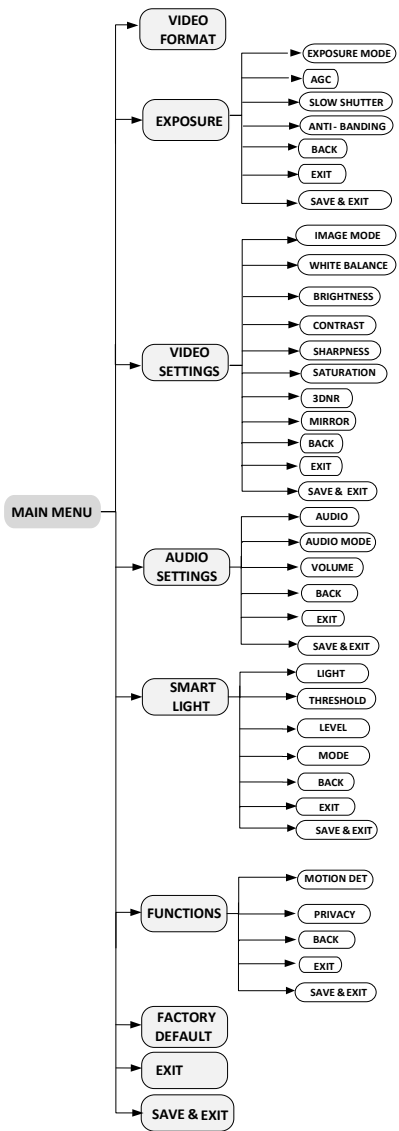

Figure 3-2 Main Menu Overview

5. Click the direction buttons to control the camera.
 - 1). Click up/down direction buttons to select menu options.
 - 2). Click Iris + to confirm the selection.
 - 3). Click left/right direction buttons to adjust the value of the selected option.

3.1 VIDEO FORMAT

You can set the video format to 2MP@25fps, 2MP@30fps, PAL, or NTSC.

3.2 EXPOSURE

EXPOSURE MODE

You can set the **EXPOSURE MODE** to **GLOBAL**, **BLC**, **HLC**, **WDR**, or **HLS**.

- **GLOBAL**

GLOBAL refers to the normal exposure mode which adjusts lighting distribution, variations, and non-standard processing.

- **BLC (Backlight Compensation)**

BLC (Backlight Compensation) compensates light to the object in the front to make it clear, but this may cause over-exposure of the background where the light is strong.

- **HLC (Highlight Compensation)**

HLC stands for highlight compensation. The camera detects strong spots (over-exposure portion of image) and reduces the brightness of strong spots to improve the overall images.

- **WDR (Wide Dynamic Range)**

The wide dynamic range (**WDR**) function helps the camera provide clear images even under back light circumstances. When there are both very bright and very dark areas simultaneously in the field of view, **WDR** balances the brightness level of the whole image and provides clear detailed images.

- **HLS (Highlight Suppression)**

It is the same visual effect as the solar eclipse. If the brightness of a part in the image exceeds the threshold, this part will become black. Then whole image can be clear.

AGC (Auto Gain Control)

It optimizes the clarity of the image in poor light conditions. The **AGC** level can be set to **HIGH**, **MEDIUM**, or **LOW**.

Note:

The noise will be amplified when setting the **AGC** level.

SLOW SHUTTER

SLOW SHUTTER increases the exposure time on a single frame, which makes a camera more sensitive to the light so it can produce images even in low lux conditions.

ANTI-BANDING

ANTI-BANDING is to prevent the phenomenon of horizontal lines (banding) when photographing images in low frequency light or high brightness environments.

3.3 VIDEO SETTINGS

Move the cursor to **VIDEO SETTINGS** and click **Iris+** to enter the submenu. **IMAGE MODE**, **WHITE BALANCE**, **BRIGHTNESS**, **CONTRAST**, **SHARPNESS**, **SATURATION**, **3DNR**, and **MIRROR** are adjustable.

| VIDEO SETTINGS | |
|----------------|---------|
| IMAGE MODE | ◀ STD ▶ |
| WHITE BALANCE | ← |
| BRIGHTNESS | ◀ 5 ▶ |
| CONTRAST | ◀ 5 ▶ |
| SHARPNESS | ◀ 5 ▶ |
| SATURATION | ◀ 5 ▶ |
| 3DNR | ◀ 5 ▶ |
| MIRROR | ◀ OFF ▶ |
| BACK | ← |
| EXIT | ← |
| SAVE & EXIT | ← |

Figure 3-3 VIDEO SETTINGS

IMAGE MODE

IMAGE MODE is used to adjust the image saturation, and you can set it to **STD** (Standard), **HIGH-SAT** (High Saturation), or **HIGHLIGHT** (better indoor facial details).

WHITE BALANCE

White balance, the white rendition function of the camera, is to adjust the color temperature according to the environment. It can remove unrealistic color casts in the image. You can set **WHITE BALANCE** mode to **AUTO**, or **MANUAL**.

- **AUTO**

Under **AUTO** mode, white balance is being adjusted automatically according to the color temperature of the scene illumination.

- **MANUAL**

You can set the **R-GAIN/B-GAIN** value to adjust the shades of red/blue color of the image.

| WHITE BALANCE | |
|---------------|------------|
| MODE | ◀ MANUAL ▶ |
| R-GAIN | ◀ 5 ▶ |
| B-GAIN | ◀ 5 ▶ |
| BACK | ⌊ |
| EXIT | ⌊ |
| SAVE&EXIT | ⌊ |

Figure 3-4 WHITE BALANCE

BRIGHTNESS

Brightness refers to the brightness of the image. You can set the brightness value from 1 to 9 to darken or brighten the image. The greater the value is, the brighter the image is.

CONTRAST

This feature enhances the difference in color and light between parts of an image.

SHARPNESS

Sharpness determines the amount of detail an imaging system can reproduce.

SATURATION

Saturation is the proportion of pure chromatic color in the total color sensation. Adjust this feature to change the saturation of the color.

3DNR (3D DNR)

3DNR refers to 3D digital noise reduction. Comparing with the general 2D digital noise reduction, the 3D digital noise reduction function processes the noise between two frames besides processing the noise in one frame. The noise will be much less and the video will be clearer.

MIRROR

Note:

The function is only supported in TVI mode.

OFF, **H**, **V**, and **HV** are selectable for mirror.

OFF: The mirror function is disabled.

H: The image flips 180° horizontally.

V: The image flips 180° vertically.

HV: The image flips 180° both horizontally and vertically.

3.4 AUDIO SETTINGS

Note:

The function is only supported in TVI mode.

AUDIO

You can turn on or off the function under this sub-menu.

AUDIO MODE

Note:

The function is only supported by DF8T series.

You can set the mode as **AUTO**, **BUILT-IN**, **LINE IN**.

- **AUTO:** The device automatically choose the way to pick up the sound.
- **BUILT-IN:** The device picks up sound via built-in microphone.
- **LINE IN:** The device picks up sound via external pick-up.

VOLUME

You can adjust the volume level under this sub-menu.

3.5 SMART LIGHT

Under the **SMART LIGHT** sub-menu, you can set the mode to **OFF** or **AUTO**.

- **OFF**

Set it to **OFF** to give up this function.

- **AUTO**

You can set **THRESHOLD** and **LEVEL** in this section.

THRESHOLD

The higher the threshold is, the more sensitive the device is to dark environment.

LEVEL

You can adjust the maximum brightness of supplement light.

MODE

The function is to reduce frame rate in low-light environment in order to increase SNR and enhance the brightness of the image.

- **MODE1:** Turn on the function.
- **MODE2:** Turn off the function.

3.6 FUNCTIONS

MOTION DET

MOTION DET refers to motion detection. With motion detection feature, motion can be detected in any part of a camera's view. You can configure full screen or a number of zones in a camera's view where motion is to be detected.

PRIVACY

This function allows you to block or mask certain area of a scene to protect personal privacy from being recorded or live viewed. You can turn on/off the **PRIVACY** to meet your needs.

3.7 FACTORY DEFAULT

Reset all the settings to factory defaults.

3.8 EXIT

Move the cursor to **EXIT** and click Iris+ to exit the menu.

3.9 SAVE & EXIT

Move the cursor to **SAVE & EXIT** and click Iris+ to save the settings and exit the menu.