

### 2015-2020 Ford F-150 Regular Cab - *Behind-the-seat Storage*

Fits DU-HA Part Number  
20114

#### Installation Instructions:

- 1 Flip and slide the seats forward so you can gain access behind the seats.
- 2 Remove the Jack. Depending on the year of your truck the jack is secured in the truck differently. Set the DU-HA (A) in the truck behind the seats. The notched area on the bottom of the DU-HA will fit around the Jack mount that is on the floor. You have 3 options for anchoring the DU-HA into your truck. Option 1 is to use Self-Tapping Screws; use this option if you want your DU-HA permanently attached in your truck. Option 2 is to use Jack-Nuts; use this option if you want to be able to remove and re-install your DU-HA in your truck. Option 3 is to use thru-bolts; use this option for a more secure permanent installation. Once you have the DU-HA in the desired position secure the DU-HA to the truck using one of the three anchoring options.



#### 3 Anchoring Option 1: Self-Tapping Screws

**Tools Needed:** // Socket – 1/4" // Socket Wrench or Drill

**Warning:** Before drilling into the truck floor make sure the area where you are going to drill through is clear of any electrical wiring, fuel lines, tanks, and reservoirs. You will have to look under the vehicle to make sure there are no obstructions at the hole locations.

Insert the Self-Tapping Screws (D) through a Washer – 1/4" (H) and the pre-drilled holes in the bottom of the DU-HA and screw through the carpet or vinyl and into the floor of the truck using a 1/4" Socket and Socket Wrench or Drill. DO NOT over-tighten.

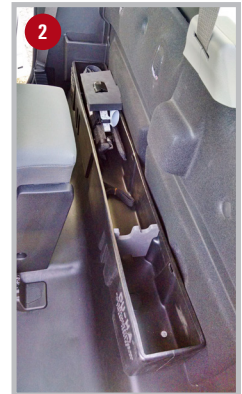

#### 4 Anchoring Option 2: Jack-Nuts

**Tools Needed:** // Drill // Nail or Sharp Punch  
// Socket – 7/16" // 7/16" Drill Bit // Hammer  
// Socket Wrench // Pliers  
// Phillips Screwdriver – #3 // Jack-Nut Friction Wrench (supplied)

**Warning:** Before drilling into the truck floor make sure the area where you are going to drill through is clear of any electrical wiring, fuel lines, tanks, and reservoirs. You will have to look under the vehicle to make sure there are no obstructions at the hole locations.

- A With the DU-HA set in your desired position, mark the two holes in the bottom of the DU-HA on the truck floor using a nail or sharp punch. You will need to poke through the carpet and make a mark on the metal floor of the truck. Next remove the DU-HA and pull back the carpet or vinyl flooring to expose the metal floor. Find the previously made marks and drill a 7/16" hole.
- B Prior to installing the Jack-Nut-1/4" (E), hold the Jack-Nut with a pliers, and using the phillips screwdriver, make a hole through the rubber on the Jack-Nut by pressing and twisting into the rubber on the head of the Jack-Nut-1/4" (E). Next insert the Bolt Hex Head – 1/4" x 2-1/2" (F) through the hole in the Jack-Nut Friction Wrench (J) and thread all the way into the Jack-Nut-1/4" (E). Place the Jack-Nut-1/4" (E) in the drilled hole (*may need a hammer to tap into hole*). Secure the Jack-Nut to the vehicle by tightening the Bolt Hex Head – 1/4" x 2-1/2" (F) using a Socket 7/16" and Socket Wrench, press firmly on the Jack-Nut Friction Wrench (J) and tighten Jack-Nut – 1/4" (E) until you see the rubber on the Jack-Nut starting to get squished. Do not over tighten (max torque = 41 in/lbs). Remove the bolt from the Jack-Nut-1/4" (E). Repeat this procedure for the other Jack-Nut.

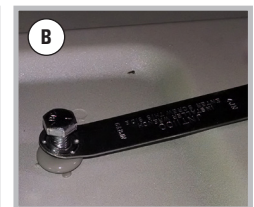
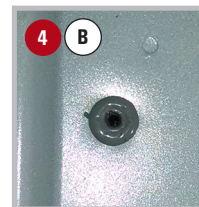
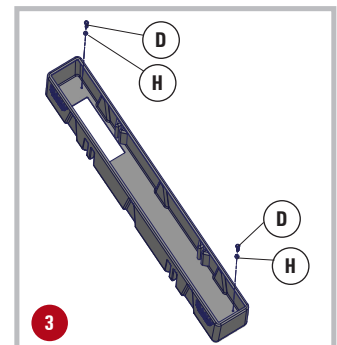

**Note:** Jack-Nut Friction Wrench is only used to install Jack-Nuts. It does not take a lot of torque to break a Jack-Nut so it is best to use a 7/16" Socket and Socket Wrench. If using a drill with a 7/16" Socket, be very careful not to over tighten and strip out the Jack-Nut.

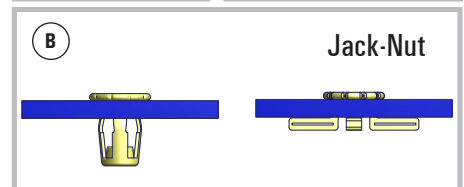

### 2015-2020 Ford F-150 Regular Cab – *Behind-the-seat Storage* Fits DU-HA Part Number 20114

#### 4 Anchoring Option 2: Jack-Nuts – Continued

- C Place the DU-HA back into the truck and position it so the Jack-Nuts line up with the holes in the DU-HA. Secure the DU-HA to the truck using Bolt Hex Head – 1/4" x 2-1/2" (F), Washer – 1/4" (H) and thread into Jack-Nut – 1/4" (E). DO NOT over tighten.

#### 5 Anchoring Option 3: Thru-Bolt – Note: This will require 2 people since you will have to go under the truck to tighten the bolts.

**Tools Needed:** // Hammer // Nail or Sharp Punch // Socket – 7/16"  
// Socket Wrench // 5/16" Drill Bit // Wrench – 7/16" // Drill

**Warning:** Before drilling into the truck floor make sure the area where you are going to drill through is clear of any electrical wiring, fuel lines, tanks, and reservoirs. You will have to look under the vehicle to make sure there are no obstructions at the hole locations.

With the DU-HA in the truck mark the two holes in the bottom of the DU-HA onto the floor of the truck using a nail or sharp punch and hammer. Remove the DU-HA and drill two 5/16" holes at the previously marked locations. Place the DU-HA back in the truck and secure with one Bolt Hex Head – 1/4" x 2-1/2" (F), two Washers – 1/4" (H), one Lock Washer – 1/4" (I) and one Nut – 1/4" (G) in two places, using Socket – 7/16", Socket Wrench and Wrench – 7/16".

#### 6 Foam Organizer / Gun Holders / Stiffeners

Place each Foam Organizer – Gun Rack (B) / Stiffener (C) assembly into the channel slots in the side walls of the DU-HA (A), facing opposing directions.

Note: You may have to flex the assembly to get it into place.

(Hint – Stock of gun should rest in large groove; barrel should rest in small groove.)

Note: With the jack installed in the Du-ha you will not be able to use the divider gun rack on the passenger side. In order to use it you will need to store the jack in a different location.

#### **Safety Instructions:**

**Warning:** Make sure the DU-HA is secured in the vehicle according to installation instructions. Do not store explosives or hazardous materials in the DU-HA.

Do not place loaded guns in the DU-HA.

For further instructions refer to truck owner's manual or contact DU-HA, Inc.

Part	Description	Qty
A	DU-HA Storage Unit	1
B	Foam Organizer / Gun Rack	2
C	Plastic Stiffener	2
D	Self-Tapping Screw	2
E	Jack-Nut – 1/4" (1-extra)	3
F	Bolt Hex Head – 1/4"x2-1/2"	2
G	Nut – 1/4"	2
H	Washer – 1/4"	4
I	Lock Washer – 1/4"	2
J	Jack Nut Friction Wrench	1

