



HITLIGHTS[®]

TriFlex Pro Dimmer Switch

With the Hitlights TriFlex Pro Dimmer Switch, you can directly replace the existing wall switches to power on and off your lights with dimming function.

KEY FEATURES

- Flicker Free
- Slim Compact Design
- UL-Listed
- Superior Dimming Performance
- 6 Years Warranty

SPECIFICATIONS

SWX-110V-600-TN-3W

Input Voltage:	120VAC ~ 60Hz
Max Load:	600W
Dimension:	4.13 x 1.73 x 1.22 in (104.90 x 43.94 x 30.99 mm)
Rated Frequency:	60Hz
Rated Wattage:	600W
IP Rating:	IP23 Dry Location
Protections:	Overheat Protection
Power Supply:	Live wire
Warranty:	3 years
Load Range:	Dimmable LED Lights 3W-200W Dimmable CFL Lamps 3W-200W Incandescent Lamps 15W-600W Halogen Lamps 15W-600W
Switch times:	=> 40000 times
Dim to Off:	No
Dimming Range:	0-100%
Operating Environment:	Temperature :0° - 40° (32F - 104F) Humidity: 10% R.H. - 90% R.H

FUNCTIONS

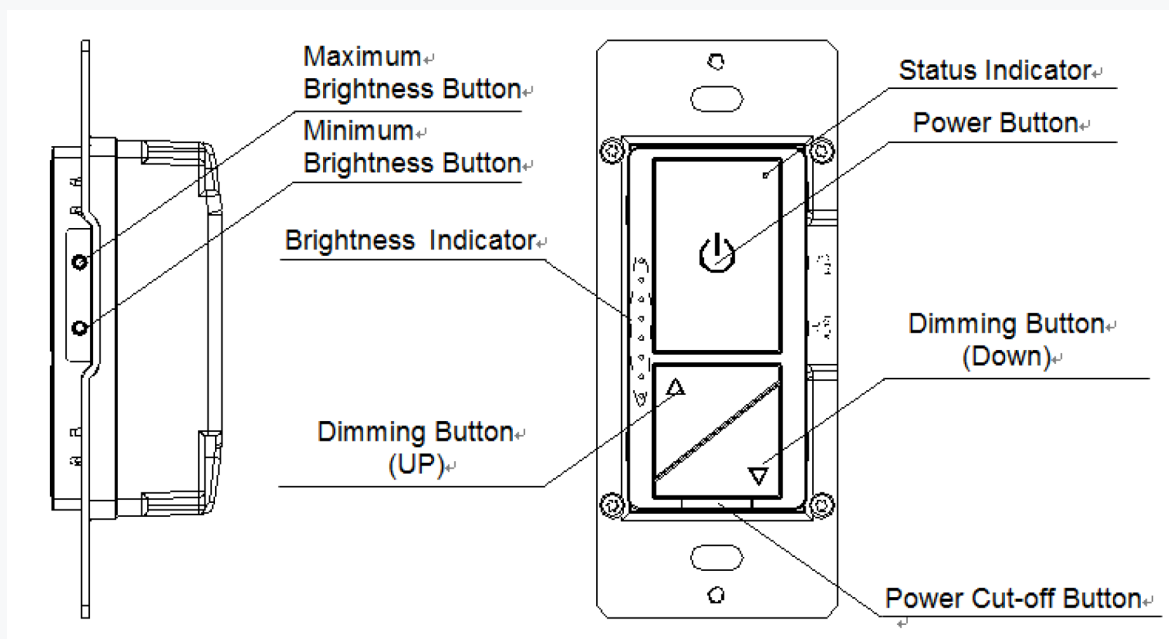

DIMENSIONS AND OUTLINE

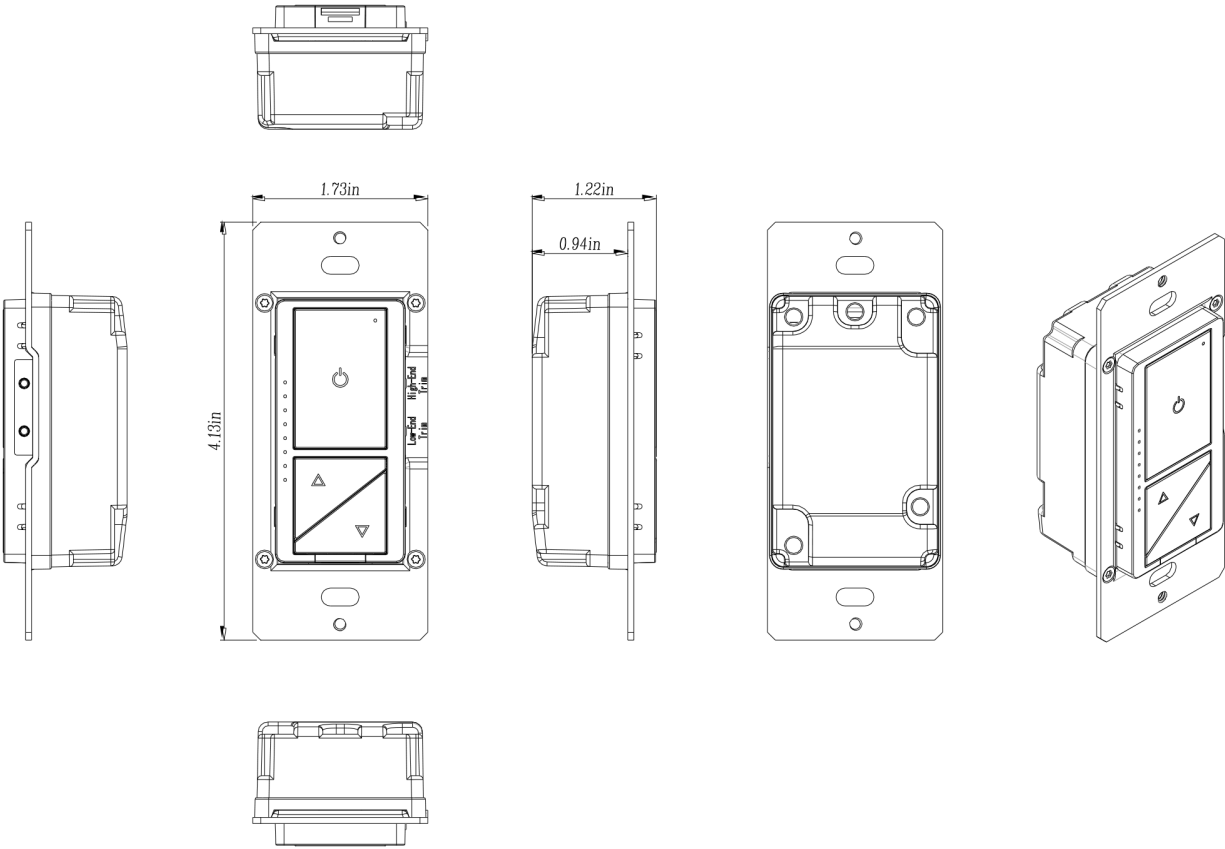

WIRING APPLICATION

1. SINGLE POLE

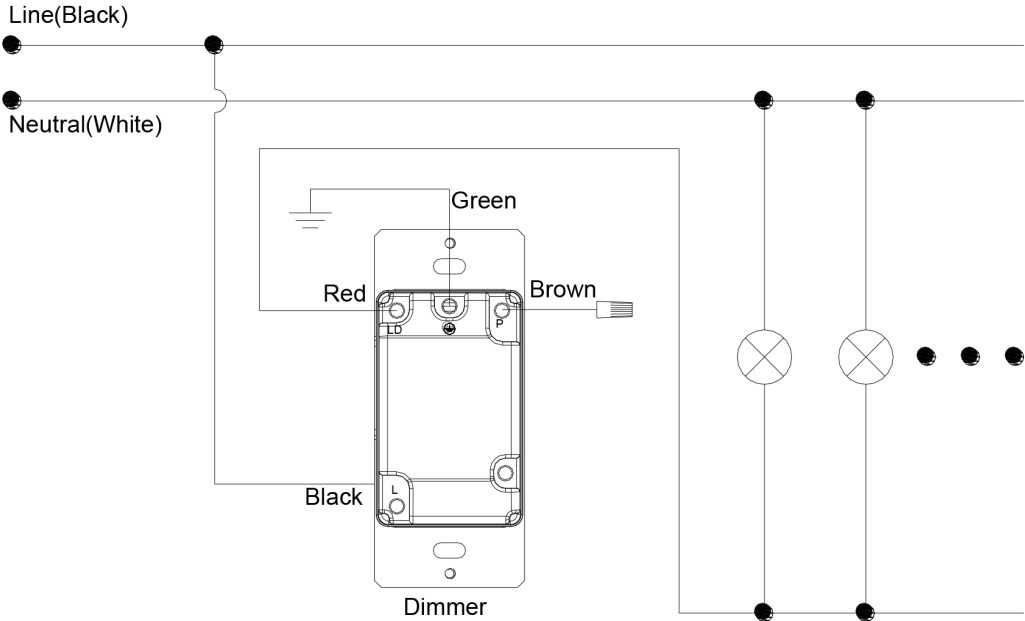

2. 3-WAY (3 WAY SWITCH) DIMMER LINE SIDE

Method One

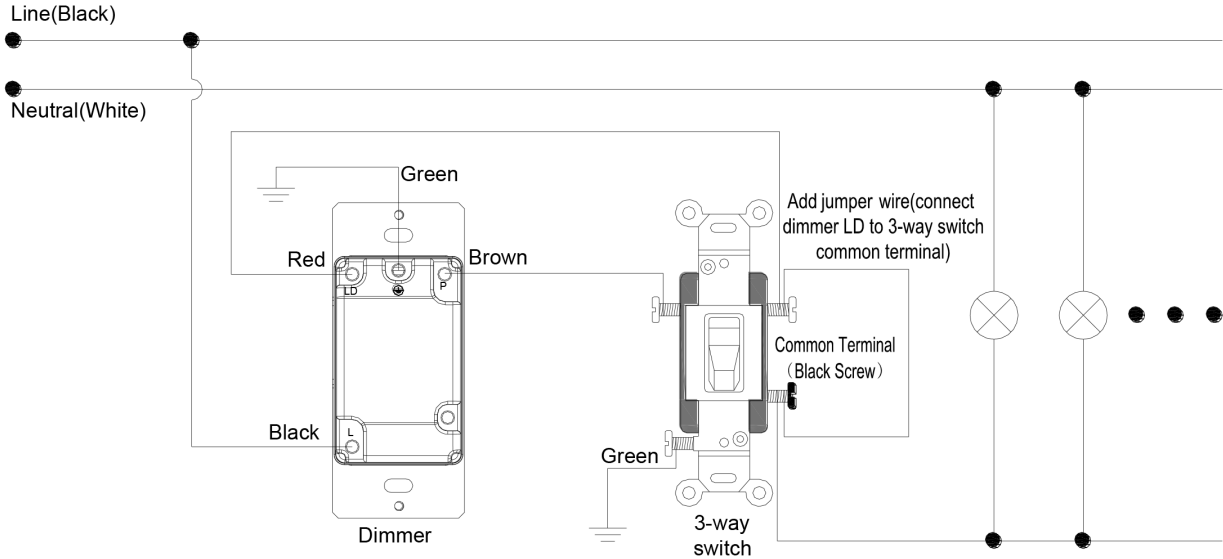

Method Two

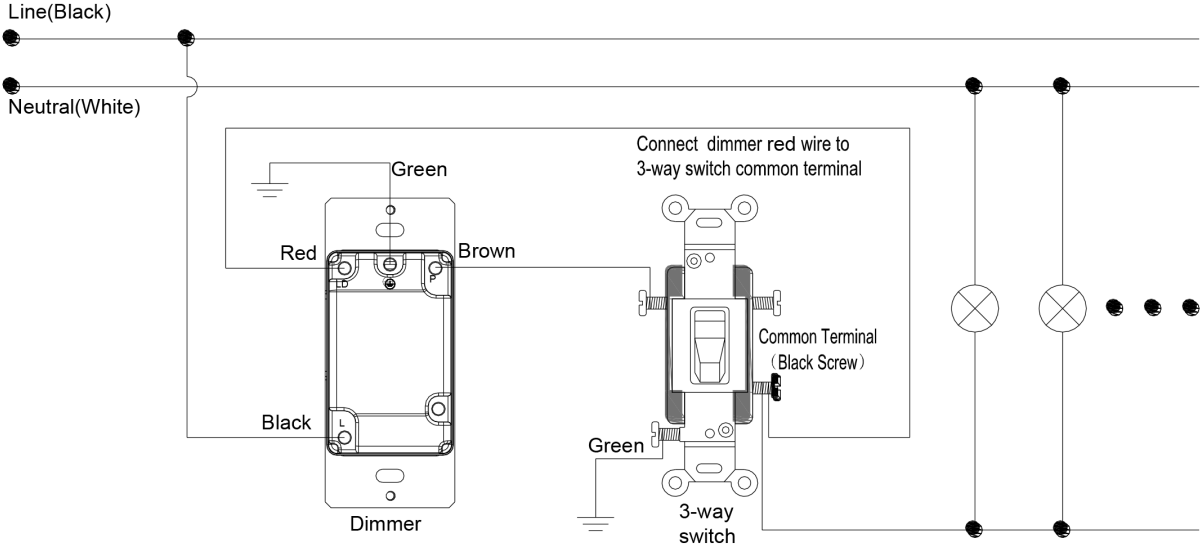

Method Three

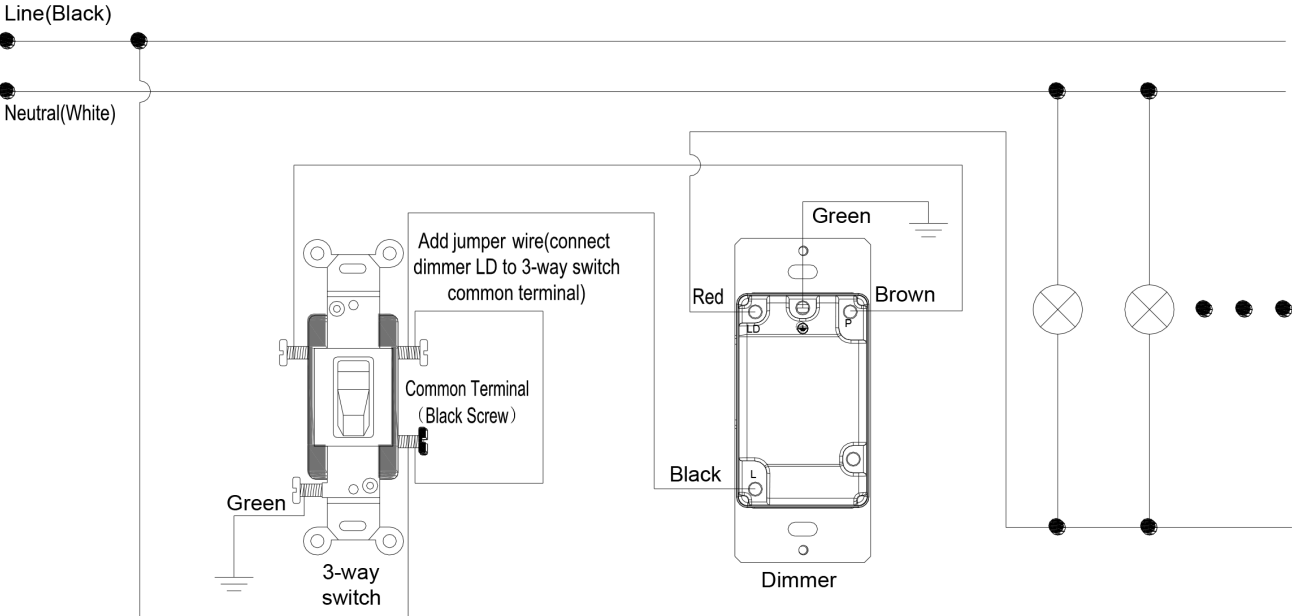

Method Four

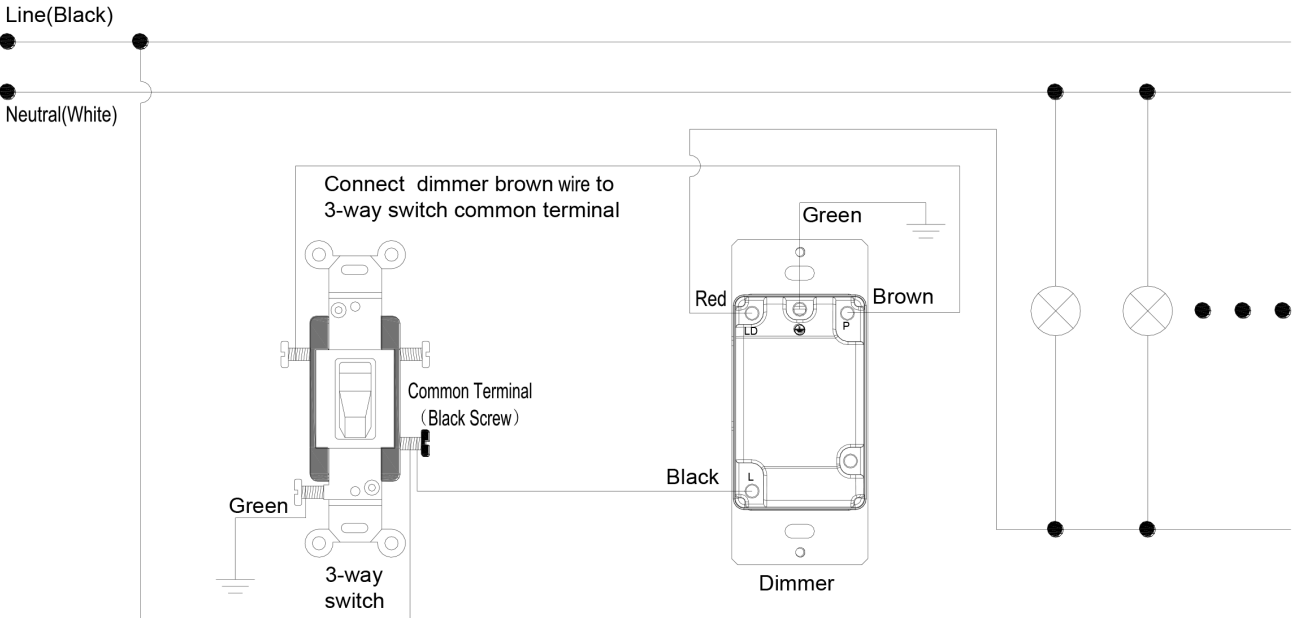

3. 3-WAY (TOGGLE SWITCH) DIMMER LINE SIDE

Method Five

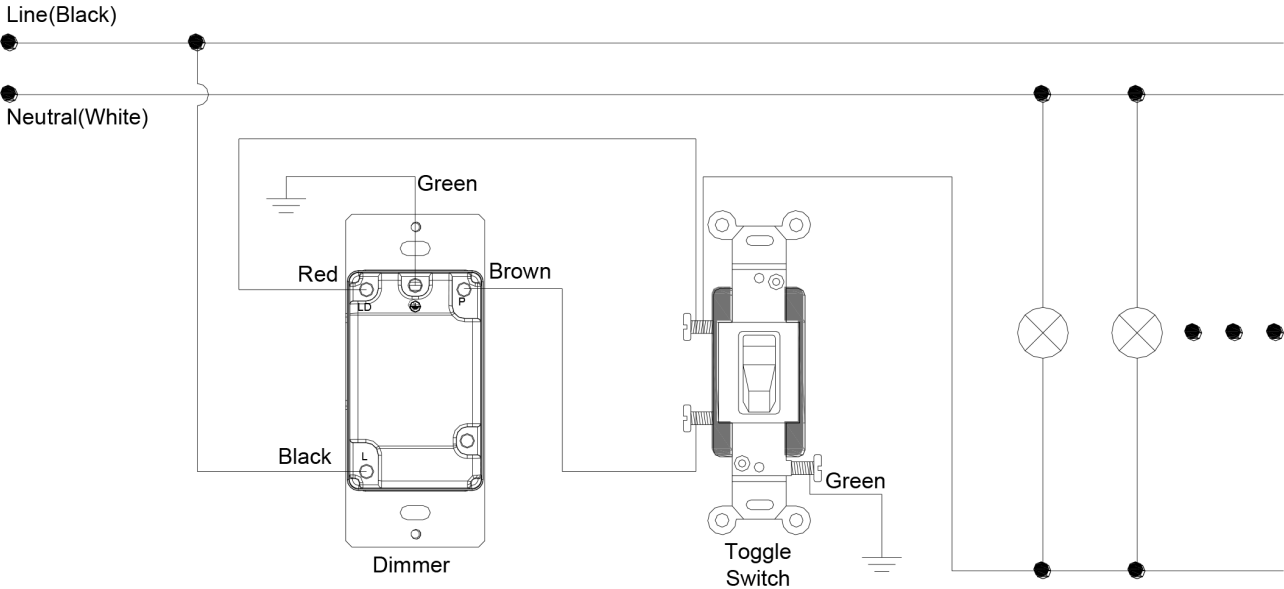

DIMMER LOAD SIDE

Method Six

