

# USER MANUAL

PORTABLE AIR  
CONDITIONER

MODEL NO. A018-12KR/C

Read all instructions carefully  
before setting up and operating  
the unit.

Keep this instruction manual for  
future reference.

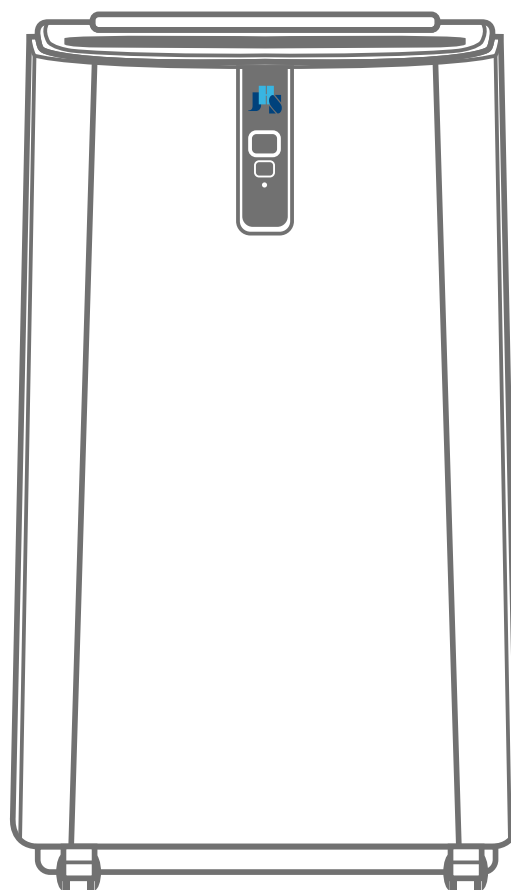

材质：157g铜版纸  
尺寸：215mm×280mm

 PANTONE 541C  
 C36 M100 Y100 K4

 PANTONE 298C

# INTRODUCTION

## DESCRIPTION OF UNIT AND PARTS

## SPECIFICATIONS

## IMPORTANT SAFETY INSTRUCTIONS

Installation and operation . . . . .	03-06
Electrical safety . . . . .	07,08

## INSTALLATION INSTRUCTIONS

Suggested tools for installation . . . . .	09
Selection of installation location . . . . .	09
Attaching exhaust hose . . . . .	09,10
Window kit installation . . . . .	10,11
Connect hose to window kit . . . . .	11
Check the sealing . . . . .	12

## OPERATION

Inserting batteries in the remote . . . . .	12
Using the remote control . . . . .	13
Control panel and remote keypad . . . . .	13,15
Water drainage . . . . .	16
Protection function of JHS portable air conditioner . . . . .	17

## CARE AND CLEANING

Cleaning the case . . . . .	17
Cleaning the filter . . . . .	18
Start - end of season operations . . . . .	18

## TROUBLESHOOTING

Before you call for service . . . . .	19
---------------------------------------	----

## WARRANTY

JHS portable air conditioner limited warranty . . . . .	20
---	----

# DESCRIPTION OF UNIT AND PARTS

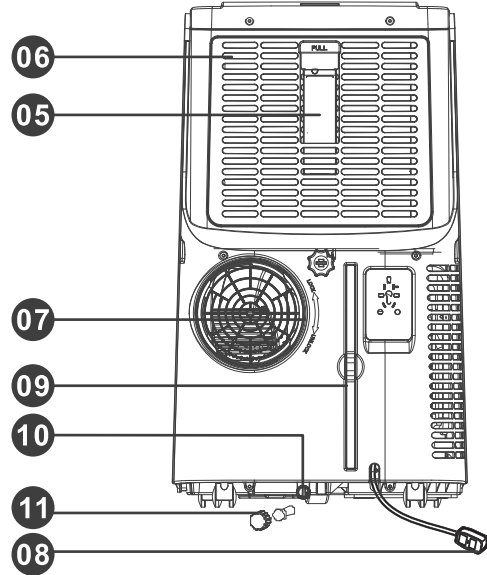
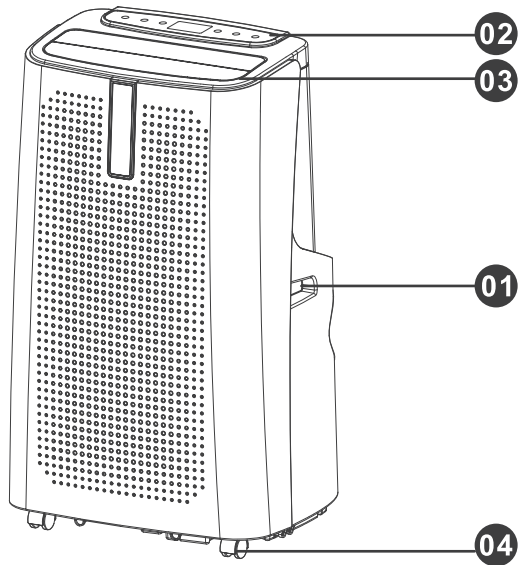

- 01 Handle
- 02 Control Panel
- 03 Air-outlet
- 04 Castor
- 05 Remote Storage Pocket
- 06 Filter Frame Upper
- 07 Exhaust Connector
- 08 Power Cord
- 09 Filter Frame Lower
- 10 Drainage Hole
- 11 Rubber Plug and Cap

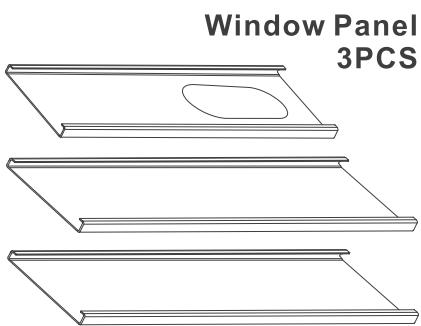
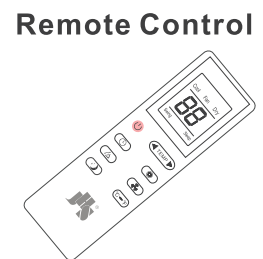
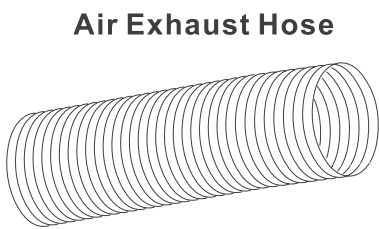

**Screw A**



**2x Wing Nut and Bolt**

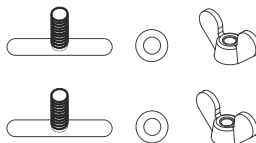

**Drain Hose**



**Drainage Joint**



## SPECIFICATIONS

Model	A018-12KR/ C	Fan Speeds	3
Energy Efficiency Ratio(EER)	2.61 Class A	Swing	Automatic
Cooling Capacity	12000BTU	Timer	YES
Noise Level	≤54dBA	Air Filter	Washable
Power Consumption	1320W/ 11.5A	Drain Options	Continuous and Manual
Estimated Cooling Area	270sq.ft (25m <sup>2</sup> ) max	Water-full Indicator	YES
Temperature Range	61°F~88°F	Unit Dimensions	16.6" W x 14.2" D x 28.5" H
Dehumidifying Capacity	59.2pints/ day	Unit Weight	60lbs
Amount Of Air Moved (CFM Max.)	220CFM	Refrigerant	R410A

## IMPORTANT SAFETY INSTRUCTIONS

### READ ALL INSTRUCTIONS BEFORE USE

Your safety and the safety of others are very important. Incorrect operation due to ignoring instruction will cause harm or damage. The seriousness is classified by the following indications.

We have provided many important safety messages in this manual and on the appliance. Always read and follow all safety messages.



***This is the safety alert symbols.***

#### **WARNING**

Failed to follow the instructions could result in death or serious injury.

#### **CAUTION**

Failed to follow the instructions could result in personal injury or property damage.

	BE SURE NOT TO DO
	BE SURE FOLLOW THE INSTRUCTIONS

## IMPORTANT SAFETY INSTRUCTIONS

### ⚠ WARNING

To reduce the risk of explosion, fire, death, electric shock, scalding, or personal injury when using this appliance, please observe the following basic precautions:

#### INSTALLATION AND OPERATION

- Some parts with sharp edges may cause injury. So gloves are highly recommended for unpacking and installing.

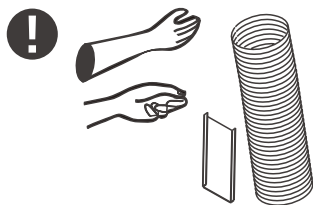

- The portable air conditioner is a heavy object, which needs two or more people to lift and install. Failed to do may result in injury or other accidents.

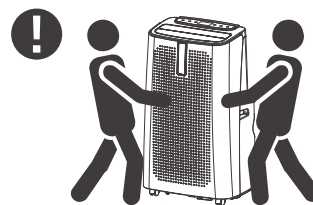

- After installation please store the carton, plastic bag, and other packing materials in a safe place to avoid children's contact. Packing materials can become airtight chambers.



- This appliance is not intended for use by persons (including children) with reduced physical, sensory or mental capabilities, or lack of experience and knowledge unless they have been given supervision or instruction concerning use of the appliance by the person responsible for their safety.

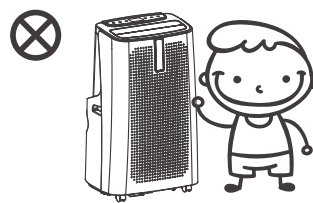

- Never attempt to operate this appliance if it is damaged, malfunctioning, partially disassembled or has missing or broken parts, including a damaged cord or plug.

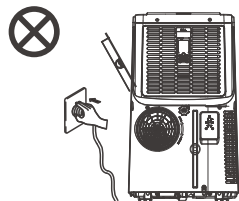

- Do not repair or replace any part of the appliance. All repairs and servicing must be performed by qualified service personnel. Use only authorized JHS factory OEM parts.



## IMPORTANT SAFETY INSTRUCTIONS

### ⚠ WARNING

To reduce the risk of explosion, fire, death, electric shock, scalding, or personal injury when using this appliance, please observe the following basic precautions:

#### INSTALLATION AND OPERATION

- Keep the product away from fire. Do not store or use flammable gases or materials near the appliance.

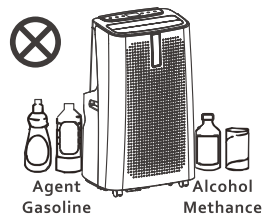

- Do not use heating equipment near the appliance.

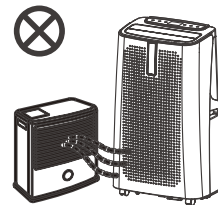

- In the event of a gas leak (propane gas, LP gas, etc.) do not operate this or any other appliance. Open a window or door to ventilate the area immediately.

- Only use the appliance in an upright position. Make sure the angle of inclination  $< 10^\circ$ . Always place the appliance on a stable, flat, level surface to prevent the air conditioner from overturning.

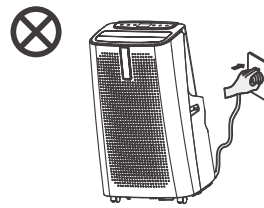
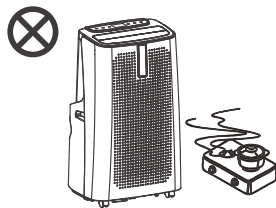

## IMPORTANT SAFETY INSTRUCTIONS

### ⚠ CAUTION

#### INSTALLATION AND OPERATION

- Read all instructions before using the appliance and save these instructions.

- Before cleaning or maintenance operations, always unplug the unit from the outlet.

- Power on this appliance in strict accordance with ELECTRICAL SAFETY guide (Page 07.)

- If the product has been submerged, contact the JHS customer service center for instructions before resuming use.

- Keep the air inlet and outlet free of obstructions.

- If the product makes a strange noise or emits a smell or smoke, pull the power plug out and contact the JHS customer service center.

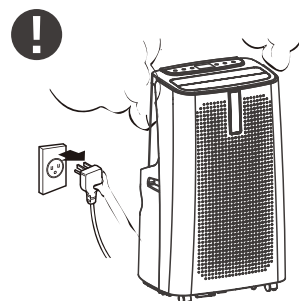
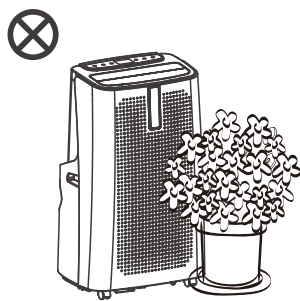

- Do not use this unit in places exposed to direct sunlight, wind or rain.

- Do not place heavy objects (>3KG) on top of the air conditioner.

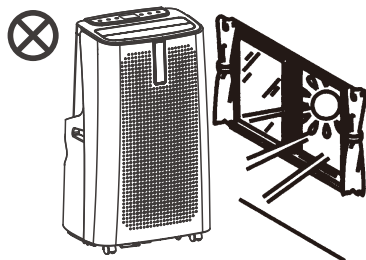

## IMPORTANT SAFETY INSTRUCTIONS

**CAUTION**

### INSTALLATION AND OPERATION

- Do not place containers with liquids on the unit.

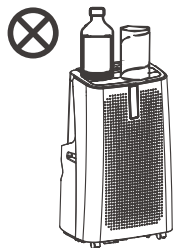

- Do not use the product in places where it could be splashed by water.

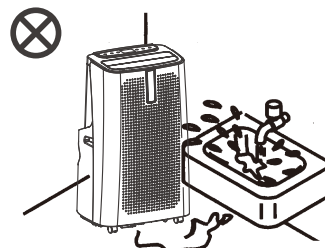

- Do not use water to clean the air conditioner.

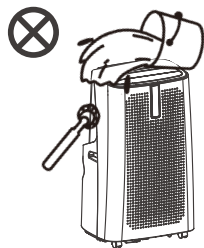

- Do not insert or place fingers or objects into the air discharge area or rear grille of the unit.

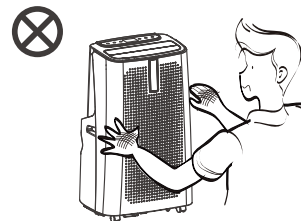

- California Safe Drinking Water and Toxic Enforcement Act :  
This product contains chemicals known to the State of California to cause cancer and birth defects or other reproductive harm. Wash hands after installation.





## IMPORTANT SAFETY INSTRUCTIONS

### ⚠ WARNING

#### READ ALL INSTRUCTIONS BEFORE USE

#### ELECTRICAL SAFETY (High voltage appliance)

- If the power cable is damaged, it must be replaced by the manufacturer or an authorized technical service center in order to avoid all risk.

During the installing or moving the appliance, be careful not to pinch, crush, or damage the power cord.

Do not damage, alter, excessively bend, twist, pull or heat the power cord.

Do not modify or extend the power cord.

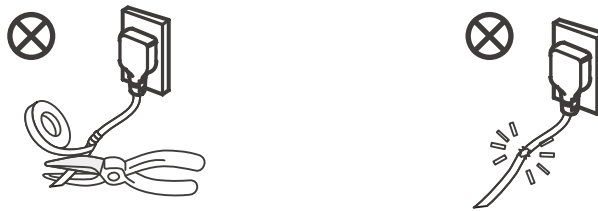

- Do not cover the power cord with a rug or carpeting.  
Do not rest hot or heavy objects on the appliance and power cable.



- Always plug into a fixed 115V AC ground outlet.  
Push the power plug all the way into the wall outlet so that it is not loose.  
Always grip the plug firmly and pull straight out from the outlet when taking it out.  
Never plug or unplug the appliance with wet hands.  
Never unplug the appliance by pulling on the power cord.  
Never use the appliance if the outlet is damaged or loose.



## IMPORTANT SAFETY INSTRUCTIONS

### ⚠ WARNING

READ ALL INSTRUCTIONS BEFORE USE

#### ELECTRICAL SAFETY (High voltage appliance)

- Do not use multiple-outlet power strip or extension cord with this appliance.  
Do not use an AC plug adapter with this appliance.  
Do not cut or remove the third (ground) prong from the power cord.

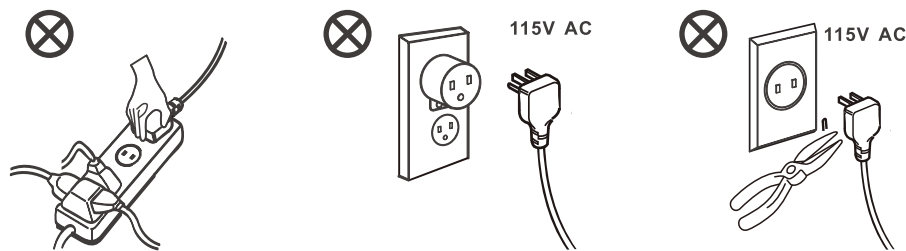

- Always finish the test of LCDI plug before use JHS air conditioner:

#### LCDI INTEGRATED CIRCUIT BREAKER

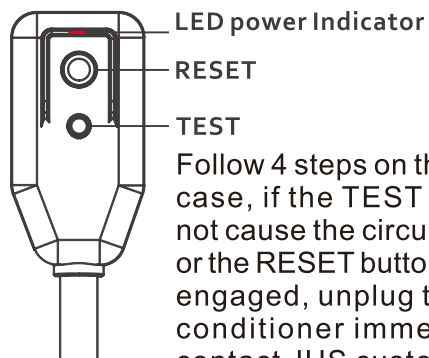

LED power Indicator

RESET

TEST

Follow 4 steps on the LCDI plug case, if the TEST button does not cause the circuit breaker trip or the RESET button will not stay engaged, unplug the air conditioner immediately and contact JHS customer service center.

#### GROUNDING METHOD

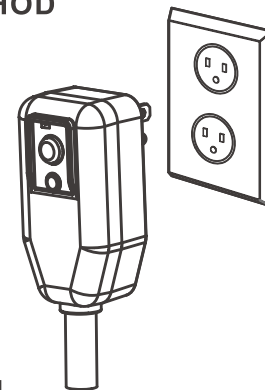

Ensure proper ground exists before use.

- Always unplug the unit from the outlet before cleaning or maintenance operations.  
Always unplug the unit if you will not use it for a long time.

## INSTALLATION INSTRUCTIONS

### SUGGESTED TOOLS FOR INSTALLATION

- Screwdrivers (medium size)
- Tape measure or ruler
- Knife or scissors
- Saw (In the event that the window kit needs to be cut down in size because the window is too narrow for direct installation)

### SELECTION OF INSTALLATION LOCATION

- 01 Place the unit near a window.
- 02 For best performance, allow at least 20inch (50cm) of air space on all sides of the unit for good air circulation.

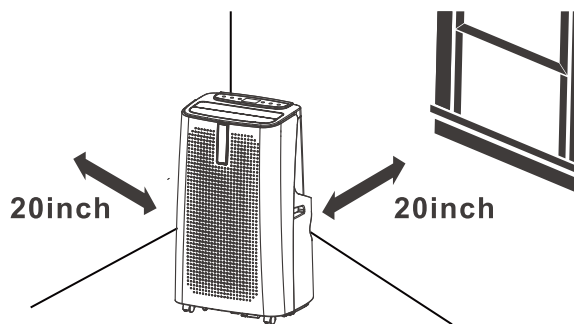

### ATTACHING EXHAUST HOSE

Install the plastic hose with window bracket adapter and hose connector on both sides. Ensure proper fit on both ends.

The supplied exhaust hose can be extended to 59inch max.

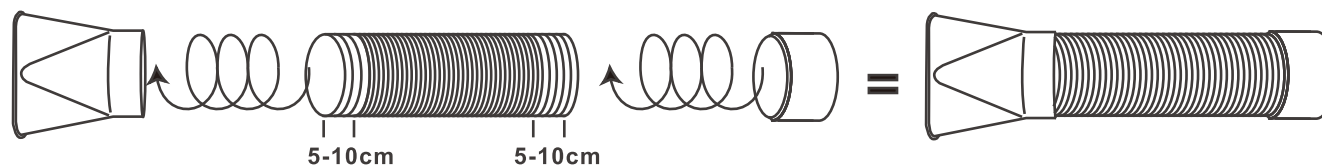

(Stretch both ends of the exhaust hose out for 10-15cm.)

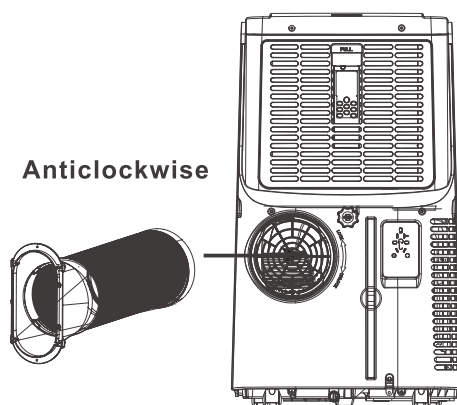

Connect the plastic hose to the hose connector on the back of the unit. Push in then rotate it anticlockwise.

# INSTALLATION INSTRUCTIONS

## ATTACHING EXHAUST HOSE

**Note :**

The length of the exhaust hose is specially designed for the unit. Do not replace or extend it with another hose as this could cause malfunction. Do not block airflow around the air conditioner. The exhaust hose should be free of any obstructions.

A bent hose will block exhaust air and cause the unit to malfunction or shut-off.

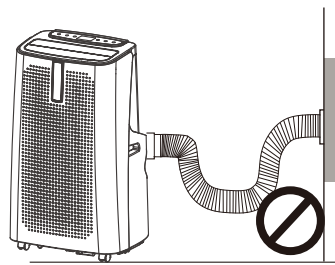

NOT RECOMMENDED

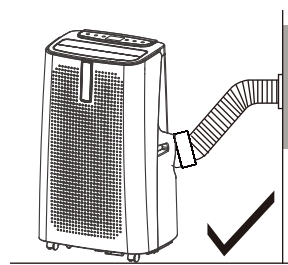

RECOMMENDED

## WINDOW KIT INSTALLATION

Your window slider kit has been designed to fit most standard "Vertical" and "Horizontal" window applications; however, it may be necessary for you to improvise / modify some aspect of the installation procedures for certain types of window. Minimum and maximum window openings:

**MAXIMUM: 57" (145 cm)**

**MINIMUM: 9" (23cm)**

Window Length	Panel A 18"	Panel B 21"	Panel C 21"	Fig.
9"-18"	✓			a
19"-38"	✓	✓		b
39"-57"	✓	✓	✓	c

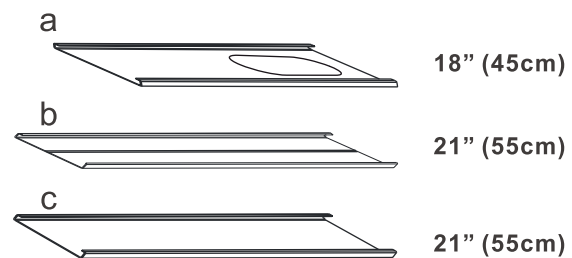

**NOTE:**

- Adjust to the desired length and use provided metal wing nuts and bolts to secure.
- If the window opening is less than 18" the minimum length of the Panel A, cut A with the hole in it short to fit for the window opening.
- Never cut out the hole in Panel A.

For a 9"-18" window opening, use panel A  
(Cut short if necessary)

Fig.a

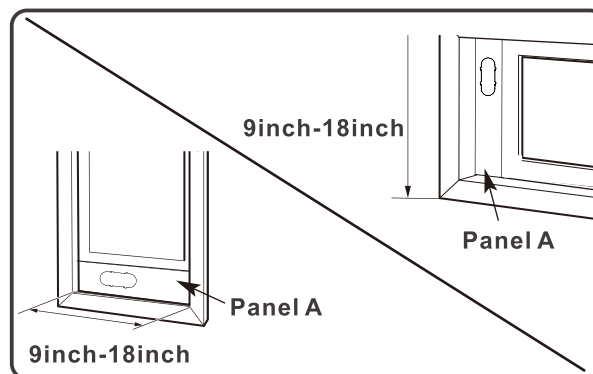

# INSTALLATION INSTRUCTIONS

## WINDOW KIT INSTALLATION

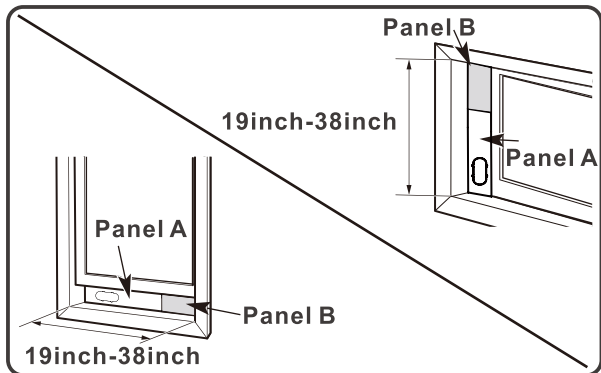

For a 19"-38" window opening, use panel A+B  
(Cut short B if necessary)

Fig.b

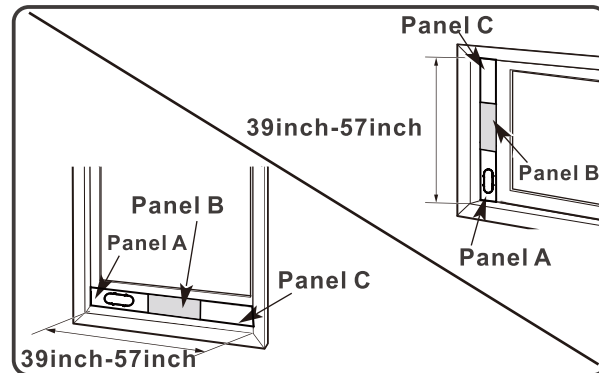

For a 39"-57" window opening, use panel A+B+C

Fig.c

## CONNECT HOSE TO WINDOW KIT

The air exhaust hose must be installed or removed from the portable air conditioner in accordance with the way it is being used:

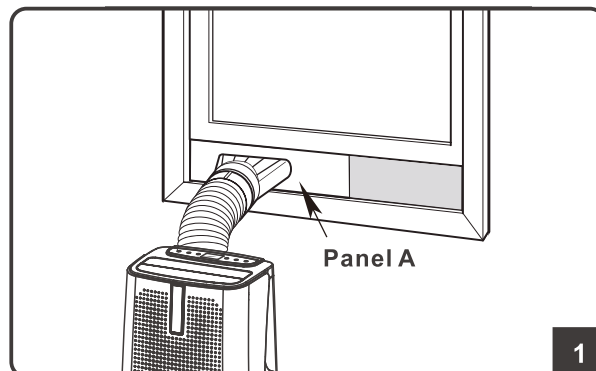

1. Insert hose outlet into the window panel A fully.

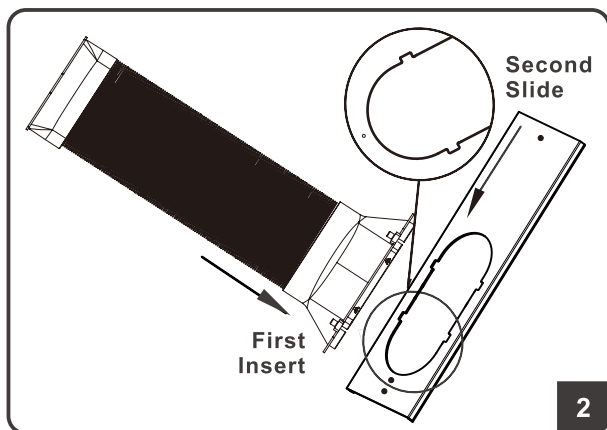

2. Slide it for locking.

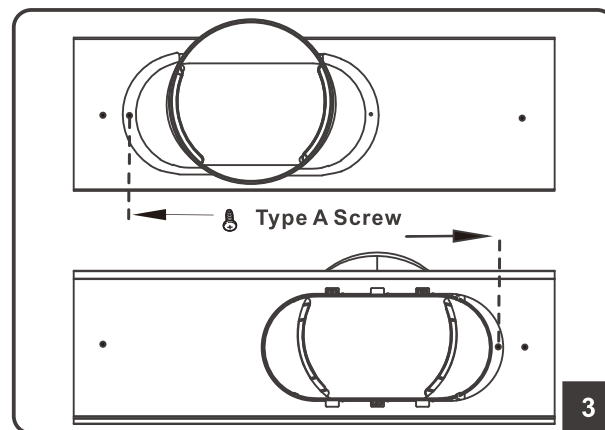

3. Fix the connection firmly, locking the type A screw.

## INSTALLATION INSTRUCTIONS

### CHECK THE SEALING

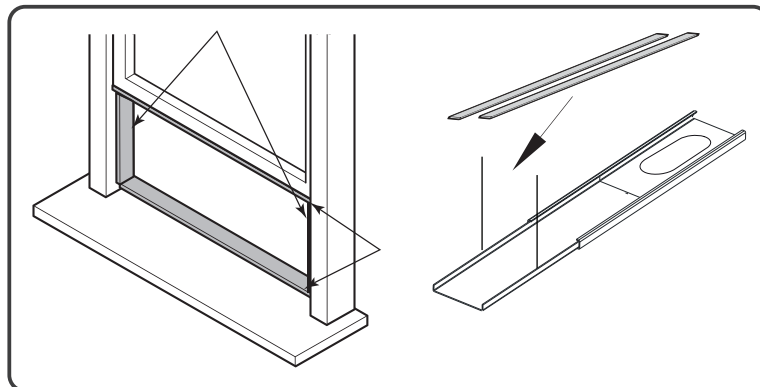

There may be a poor sealing effect because the gap is too large on some special window. Please purchase appropriate foam seal (not included in the package), in order to strengthen air conditioning refrigeration effect.

## OPERATION

### INSERTING BATTERIES IN THE REMOTE

- 01 Press and glide the battery cover on the rear of the remote, remove the cover.
- 02 Insert two new R03 “AAA” 1.5V batteries into the battery compartment. Make sure the polarity is correct.
- 03 Battery is not included in the package because of transportation safety.

Make sure the polarity is correct.

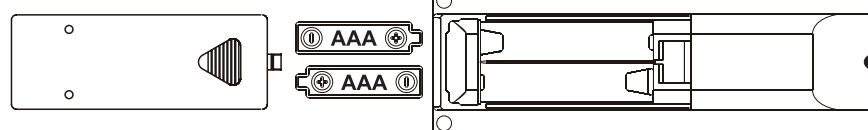

#### NOTE:

- Do not mix old and new batteries. Do not mix alkaline, standard (carbon-zinc) or rechargeable batteries.
- If the remote control is not be used for a certain length of time, remove the batteries (Batteries may explode or leak).
- If the remote control unit is replaced or discarded, the batteries must be removed and disposed of in accordance with current legislation as they are harmful to the environment.

## INSTALLATION INSTRUCTIONS

### USING THE REMOTE CONTROL

Point the remote control to the air conditioner. The remote control must be no more than 16Ft (5 meters) away from the appliance (without obstacles between the remote control and the appliance).

The remote control must be handled with extreme care. Do not drop it or expose it to direct sources of heat, sunlight or water.



## OPERATION

### CONTROL PANEL AND REMOTE KEYPAD

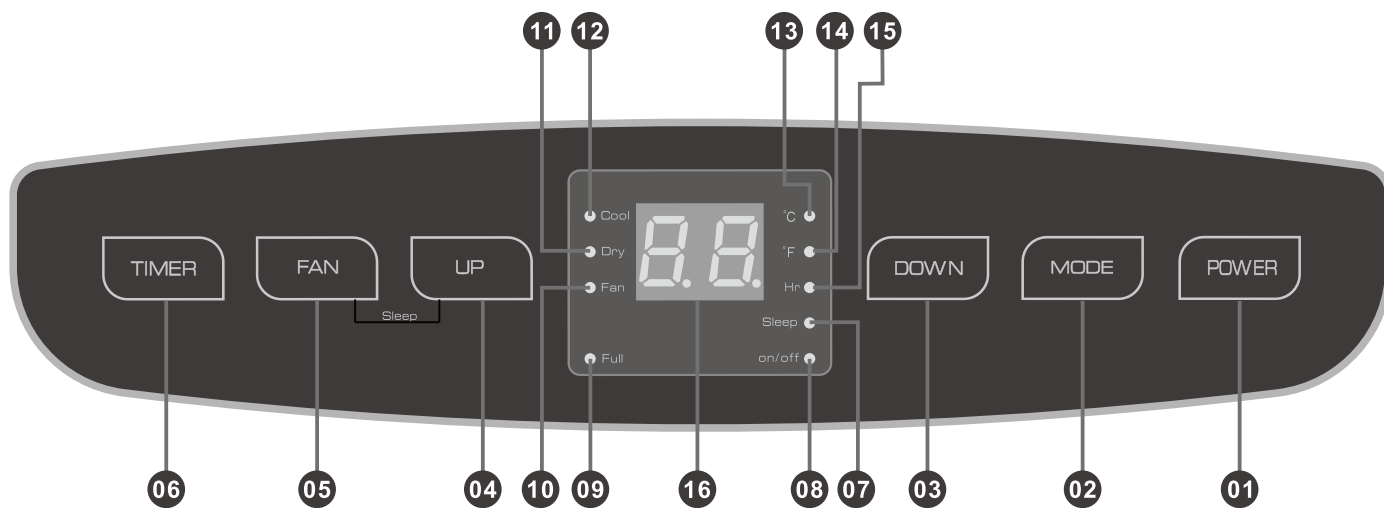

- |                                  |  |
|----------------------------------|--|
| <b>01</b> Power button           | <b>09</b> "Water full" indicator         |
| <b>02</b> Mode button            | <b>10</b> "Fan mode" indicator           |
| <b>03</b> Down button            | <b>11</b> "Dehumidifying mode" indicator |
| <b>04</b> Up button              | <b>12</b> "Cooling mode" indicator       |
| <b>05</b> Fan button             | <b>13</b> "TEMP-°C" indicator            |
| <b>06</b> Timer button           | <b>14</b> "TEMP-°F" indicator            |
| <b>07</b> "Sleep mode" indicator | <b>15</b> "Hour" indicator               |
| <b>08</b> "On/Off" indicator     | <b>16</b> LCD display                    |

## OPERATION

### CONTROL PANEL AND REMOTE KEYPAD

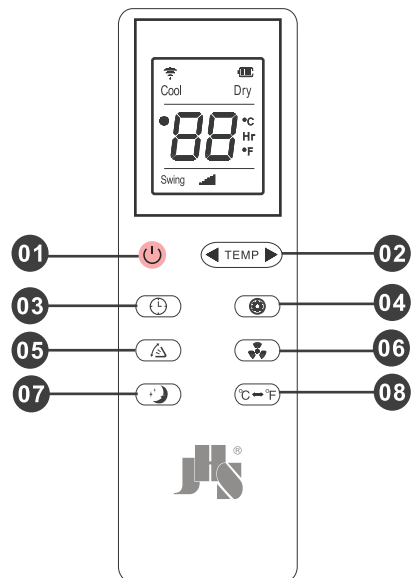

- 01 Power button
- 02 Up & Down button
- 03 Timer button
- 04 Mode button
- 05 Swing button
- 06 Fan button
- 07 Sleep button
- 08 °C °F switch button

## OPERATION

### CONTROL PANEL AND REMOTE KEYPAD

*OPERATION OF FUNCTIONS IS THE SAME WHEN USING REMOTE OR CONTROL PANEL, UNLESS OTHERWISE STATED.*

1. When the machine is powered on for the first time, the buzzer will sound “power-on” tone, and then the unit will get into standby status. LCD displays current TEMP.

2. Power button  or  (on the remote)

Press the key to turn on and turn off the unit. In the case of power on, press the key to turn off the machine; in the case of power off, press the key to turn on the unit.

3. Mode Selection  or  (on the remote)

In the case of power on, press the key to switch between Cooling → Dehumidifying → Fan mode.



## OPERATION

### CONTROL PANEL AND REMOTE KEYPAD



#### 4. Up button and Down button

Press the two keys to change the temperature setting value, operation procedure as follow:  
While setting temperature, press up key or down key to select the required temperature (Non-available in Fan or Dehumidifying mode). Adjustable between 61°F ~ 88°F (16°C~31°C).

#### 5. Fan Speed Selection or (on the remote)

In Cooling and Fan mode, press the key to select high, medium or low wind speed operation.  
In Dehumidifying mode, pressing the key is non-effective, and the fan will forcibly choose low wind speed operation.

#### 6. Timer or (on the remote)

In the case of power on and the unit is turn off, press the key to set time for turning on the unit.  
In the case of power on and the unit is turn on, press the key to set time for turning off the unit.  
Press this key, when the timing symbol flashes (Hour indicator), then press   to select the required timing value.  
Timing values can be set within 01-24 hours and the timing value is adjusted by one hour.  
Timing mode can be turned off by set time values **00** or power off.

#### 7. Sleep Mode (On the panel, simultaneously press both keys) (On the remote)

In the cooling mode, press the key to enter the sleep mode, the unit will work on energy-saving and quiet mode.  
Sleep mode is non-effective in the Dehumidifying or Fan mode.

## OPERATION

### WATER DRAINAGE

JHS portable air conditioner has a self-evaporative system. The condensed water will be recycled to the working compressor and evaporator, most of the water will be evaporated. This work procedure can not only improve cooling efficiency but also save energy for all customers.

Since most of the condensed water will be used to aid the compressor, there is no need of drain hose in general using environment.

If you use the portable air conditioner for cooling or dehumidifying in a high humidity situation (Relative humidity >85%, like New Orleans, Louisiana, Jacksonville, Florida, Houston), the collected excess water will need to be drained through a drain plug in the bottom of the unit. With a full reservoir, the compressor will stop working.

#### Continuous drainage

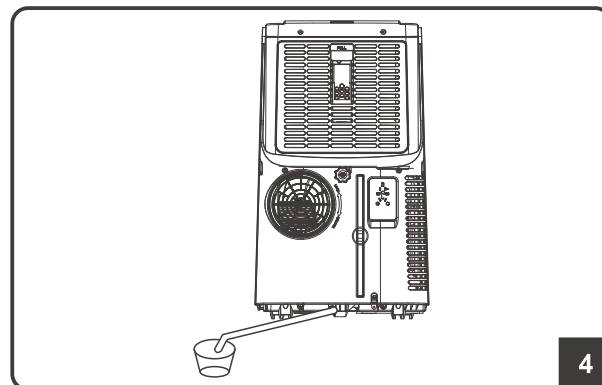
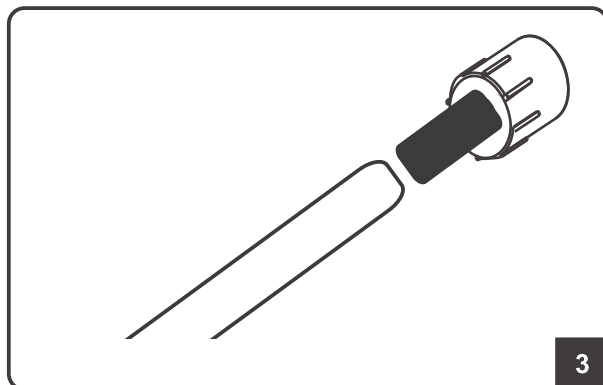
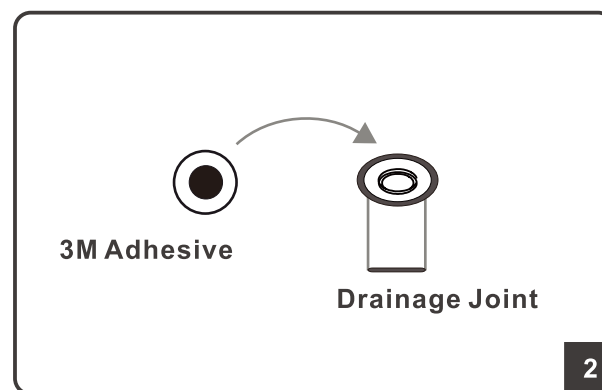
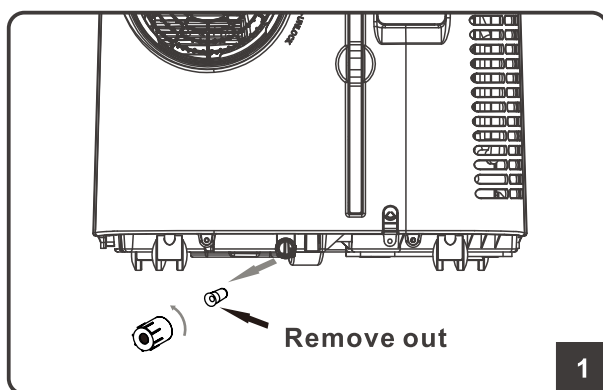

1. Unscrew the water stopper and unplug the rubber plug.
2. Assemble the water stopper and hose connector and fix into the unit.
3. Push the water hose into the hose connector.
4. Connect the drainage pipe to the water container or drainage ditch to outdoor.  
The length of provided drainage pipe is 24inch (60cm), pipe diameter is 0.4inch(1cm)

## OPERATION

### PROTECTION FUNCTION OF JHS PORTABLE AIR CONDITIONER

#### 1. Frost Protection Function:

In a cold environment, if the temperature of the EVA pipe sensor is too low, the machine will automatically enter protection status; if the temperature of the EVA pipe sensor rises to a certain temperature (10°C), it can automatically revert to normal operation.

#### 2. Overflow Protection Function:



When water in the water pan exceeds the warning level, the machine will automatically sound an alarm and stop working, and the W.F indicator will flash. At this time, you need to drain the water (details see Drainage Instructions at the end of this chapter).

After the water is emptied, the unit will work normal again.

#### 3. Protection Function of the Compressor:

To increase the service life of the compressor, it has a 3-minute delay booting protection function after the compressor is turned off.

## CARE AND CLEANING

Before cleaning or maintenance, turn the appliance off by pressing the button  on the control panel or button  on the remote control. Wait for 5-10 minutes then unplug from the electrical outlet.

### CLEANING THE CASE

*You should clean the appliance with a slightly damp cloth then dry with a dry cloth.*

- Never wash the air conditioner with water. It could be dangerous because of short circuit or fire.
- Never use petrol, alcohol or solvents to clean the appliance.
- Never spray insecticide liquids or similar.

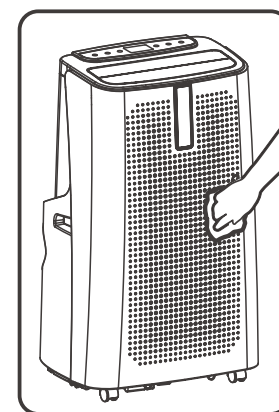

## CARE AND CLEANING

### CLEANING THE FILTER

*If the air filter is clogged with dust, the effectiveness of the air conditioning will be reduced. To keep your air conditioner working efficiently, you should clean the evaporator filter every two weeks of operation.*

- Clasp the wedging block of the upper air filter screen frame with hands, and force down from the outside to remove the air filter screen frame. Unscrew the four fixing screws and remove the upper air filter screen. Clasp the wedging block and directly pull out the lower filter screen.
- Put the air filter screen into warm water (about 40°C / 104°F) with neutral detergent, dry it in the shade after rinsing clean.
- If it is very dirty, use a vacuum cleaner to remove dust accumulations from the filter. Immerse in warm water and rinse a number of times.
- After washing, leave the filter to dry then re-insert the filter.
- Never operate the air conditioner if the air filter is taken out.

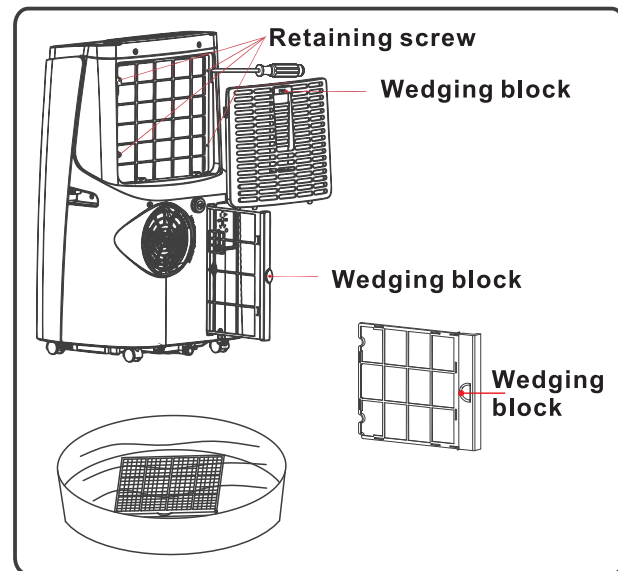

### START - END OF SEASON OPERATIONS

#### END OF SEASON OPERATIONS

- 01 Remove the cap, run off all water left into the basin. When all the water has been drained, put the cap back in place.
- 02 Clean the filter and dry thoroughly before putting back.
- 03 Remove the batteries from the remote.
- 04 Store the unit in a cool, dry room, away from direct sunlight, extreme temperatures, and excessive dust. Keep it out of the reach of children.

#### START OF NEW SEASON CHECKS

- 01 Make sure the power cable and plug are undamaged.
- 02 Follow the installation instructions precisely, install the unit again.
- 03 Place new batteries into remote.

# TROUBLESHOOTING

## BEFORE YOU CALL FOR SERVICE

- Check to make sure that the air conditioner is plugged in securely. If it is not, remove the plug from the outlet, wait 10 seconds and plug it in again firmly.
- Check the blown circuit fuse or the tripped main circuit breaker. If they work properly, test the outlet with another appliance.

Troubleshoot your problem by using the chart below. This list includes common occurrences that are not the result of a defect in factory workmanship or materials.

If the air conditioner still does not work properly, contact JHS customer service center. Customers must never troubleshoot internal components.

TROUBLE	POSSIBLE CAUSE	POSSIBLE REMEDY
Unit does not start when pressing ON/OFF button.	<ul style="list-style-type: none"> <li>A. Water-full indicator flash in the LCD display.</li> <li>B. Room temperature is lower than the set temperature (cooling mode).</li> <li>C. The ambient temperature is too low.</li> <li>D. In dehumidifying mode, ambient temperature is low.</li> </ul>	<ul style="list-style-type: none"> <li>A. Drain the water in the bottom tray.</li> <li>B. Reset the temperature.</li> <li>C. Recommend to use the unit in at the temperature of 7-35°C (44-95 °F) for cooling mode.</li> <li>D. Recommend to use the unit in at the temperature of 17-35 °C (62-95 °F) for dehumidifying mode.</li> </ul>
The cooling effect is not good.	<ul style="list-style-type: none"> <li>A. There is direct sunlight.</li> <li>B. Doors or windows are open.</li> <li>C. There are other sources of heat in cooling mode.</li> <li>D. The air filter is dirty.</li> <li>E. The air inlet or outlet is blocked.</li> </ul>	<ul style="list-style-type: none"> <li>A. Pull the curtain.</li> <li>B. Make sure all the windows and doors are closed.</li> <li>C. Remove the heat sources if possible.</li> <li>D. Clean the air filter.</li> <li>E. Make sure the exhaust hose is assembled properly.</li> </ul>
Big noise or vibration.	<ul style="list-style-type: none"> <li>A. The surface is not level or not flat enough.</li> </ul>	<ul style="list-style-type: none"> <li>A. Put the air conditioner on a flat and hard place.</li> </ul>
The remote control does not work.	<ul style="list-style-type: none"> <li>A. The distance between the machine and the remote control is too far.</li> <li>B. The remote control is not aligned with the direction of the remote control receiver.</li> <li>C. Batteries are dead.</li> </ul>	<ul style="list-style-type: none"> <li>A. Let the remote control get close to the air conditioning &lt;5M.</li> <li>B. Make sure that the remote control directly faces to the direction of the remote control receiver.</li> <li>C. Replace batteries.</li> </ul>

## WARRANTY

### JHS PORTABLE AIR CONDITIONER LIMITED WARRANTY

Any repair, replacement, or warranty service, and all questions about this product should be directed to customer service center.

The warranty commences the day the product is purchased and covers up to a period of 1 year (12 months) for parts (manufacturing defects only).

JHS will replace the defective product with either a new or remanufactured unit equivalent to your original purchase during the warranty period.

**Exclusions: This warranty does not apply to the below:**

- If the appearance or exterior of the product has been damaged or defaced, altered or modified in design or construction.
- If there is damaged due to power line surge, user damage to the AC power cord or connection to an improper voltage source.
- If the damage is due to general misuse, accidents.
- Damages caused by unauthorized repair and using of non-genuine parts.
- On products that have been purchased as refurbished, like new, second-hand.
- Unit used in a commercial or rental setting.
- Damages caused by improper installations.

We promise to answer your inquiry within 24hours (working day) and provide you an amicably happy solution.

Email: [cs@acjhs.com](mailto:cs@acjhs.com)

Website: [www.acjhs.com](http://www.acjhs.com)

*All the technical and specific parameters, please refer to product nameplate.*

*Due to continuous improvement, JHS reserves the right to change some design without timely notice.*



Electrical products should be properly disposed.

Please recycle where facilities exist.



Check with your local authority or retailer for recycling.



Your cold day in the summer

[www.acjhs.com](http://www.acjhs.com)



Printed In China