

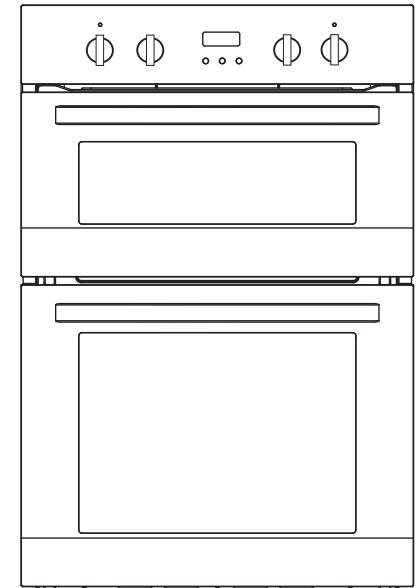

CAO888X
CAO888B
CAO888W
CAO888X/1



INSTRUCTION MANUAL

Do not use the oven until you have read this instruction manual

DEAR CUSTOMER

Dear Customer

Thank you for having purchased and given your preference to our product.

The safety precautions and recommendations within this booklet are for your own safety and that of others. They will also provide a means by which to make full use of the features offered by your appliance.

Please preserve this booklet carefully. It may be useful in future, either to yourself or to others in the event that doubts should arise relating to its operation.

This appliance must be used only for the task it has explicitly been designed for, that is for cooking foodstuffs. Any other form of usage is to be considered as inappropriate and therefore dangerous.

The manufacturer declines all responsibility in the event of damage caused by improper, incorrect or illogical use of the appliance.

TABLE OF CONTENTS

Safety instructions.....	4
How to save energy.....	5
Unpacking.....	5
Disposal of the appliance.....	6
Description of the appliance.....	7
Installation.....	8
Operation.....	11
Control panels.....	11
Top natural convection.....	12
Bottom main fan oven.....	15
Cooking advice.....	18
Prior first use.....	19
Electronic programmer.....	19
Cleaning and maintenance.....	25
Oven.....	25
Operation in case of emergency.....	28
Baking in the oven.....	29
Technical information.....	35

SAFETY INSTRUCTIONS

IMPORTANT SAFEGUARDS & RECOMMENDATIONS

- Do not carry any cleaning or maintenance without first disconnecting the appliance from the electrical supply.
- During and after use of the double oven, certain parts will become very hot. Do not touch hot parts.
- After use always ensure that the control knobs are in the "0" **OFF position**.
- Keep children away from the double oven during use.
- Household appliances are not intended to be played with by children.
- Children, or persons with a disability which limits their ability to use the appliance, should have a responsible person to instruct them in its use. The instructor should be satisfied that they can use the appliance without danger to themselves or their surroundings.
- **WARNING**
When correctly installed, your product meets all safety requirements laid down for this type of product category. However special care should be taken around the rear or the underneath of the appliance as these areas are not designed or intended to be touched and may contain sharp or rough edges, that may cause injury.
- **WARNING**
Ensure that the appliance is switched off before replacing the lamp to avoid the possibility of electric shock.
- If the supply cord is damaged, it must be replaced by the manufacturer, its service agent or similarly qualified persons in order to avoid a hazard.
- **Fire Risk!** Do not store inflammable materials inside the ovens.
- Always use oven gloves when removing the shelves and food trays from the oven whilst hot.
- Do not line the oven walls with aluminium foil. Do not place baking trays or the drip tray on the base of the oven chamber.
- Clean the ovens regularly and do not allow fat or oils to build up in the oven base or trays. Remove spillages as soon as they occur.
- Always stand back from the oven when opening the oven door to allow steam and hot air to escape before removing the food.
- Do not hang towels, dishcloths or other items on the cooker or its handle - as this could be a fire hazard.
- Make sure that electrical cords connecting other appliances in the proximity cannot become entrapped in the oven doors.
- Before disposing of an unwanted appliance, it is recommended that it is made inoperative and that all potentially hazardous parts are made harmless.
- **Important:** This appliance has been designed for domestic use only. The appliance is **NOT** suitable for use within a semi-commercial, commercial or communal environment.
- **Safe food handling:** leave food in the oven for as short a time as possible before and after cooking. This is to avoid contamination by organisms which may cause food poisoning. Take particular care during warmer weather.

HOW TO SAVE ENERGY



Using energy in a responsible way not only saves money but also helps the environment.

So let's save energy! And this is how you can do it.

- Make use of residual heat from the oven. If the cooking time is greater than 40 minutes, switch off the oven 10 minutes before the end time. Important when using the timer, set appropriately shorter cooking times according to the dish being prepared.
- Make sure the oven door is properly closed. Heat can leak through spillages on the door seals. Clean up any spillages immediately.
- Do not install the oven in the direct vicinity of refrigerators/freezers. Otherwise energy consumption increases unnecessarily.

UNPACKING



During transportation, protective packaging was used to protect the appliance against any damage.

After unpacking, please dispose of all elements of packaging in a way that will not cause damage to the environment. All materials used for packaging the appliance are environmentally friendly; they are 100% recyclable and are marked with the appropriate symbol.

Caution!

During unpacking, the packaging materials (polythene bags, polystyrene pieces, etc.) should be kept out of reach of children.

DISPOSAL OF THE APPLIANCE



Old appliances should not simply be disposed of with normal household waste, but should be delivered to a collection and recycling centre for electric and electronic equipment.

A symbol shown on the product, the instruction manual or the packaging shows that it is suitable for recycling.

Materials used inside the appliance are recyclable and are labelled with information concerning this. By recycling materials or other parts from used devices you are making a significant contribution to the protection of our environment.

Information on appropriate disposal centres for used devices can be provided by your local authority.

DESCRIPTION OF THE APPLIANCE

BEFORE USING FOR THE FIRST TIME

- Read the instructions carefully before installing and using the appliance.
- After unpacking the appliance, check that it is not damaged. In case of doubt, do not use the appliance and contact your supplier or a qualified engineer.
- Remove all the packing materials (i.e. plastic bags, polystyrene foam, etc.) and do not leave it around within easy reach of children, as these may cause serious injuries.
The packing materials are recyclable.
- Do not attempt to modify the technical characteristics of the appliance, as it may become dangerous to use.
- The appliance should be installed and all the electrical connections made by a qualified engineer in compliance with local regulations in force and following the manufacturer's instructions.

IMPORTANT PRECAUTIONS AND RECOMMENDATIONS FOR USE OF ELECTRICAL APPLIANCES

Use of any electrical appliance implies the necessity to follow a series of fundamental rules. In particular:

- Never touch the appliance with wet hands or feet;
- Do not operate the appliance barefooted;
- Do not allow children or disabled people to use the appliance without your supervision.

The manufacturer cannot be held responsible for any damages caused by improper, incorrect or unreasonable use of the appliance.

USING THE DOUBLE OVEN FOR THE FIRST TIME

You are advised to carry out the following operations:

- Assemble the interior of the oven as described under the heading "Cleaning and maintenance".
- Switch the empty oven ON at maximum temperature for about two hours to eliminate traces of grease and smell from the components
- Let the oven cool down, switch off the electrical supply, then clean the inside of the oven with a cloth soaked in water and neutral detergent and dry thoroughly.

DESCRIPTION OF THE APPLIANCE

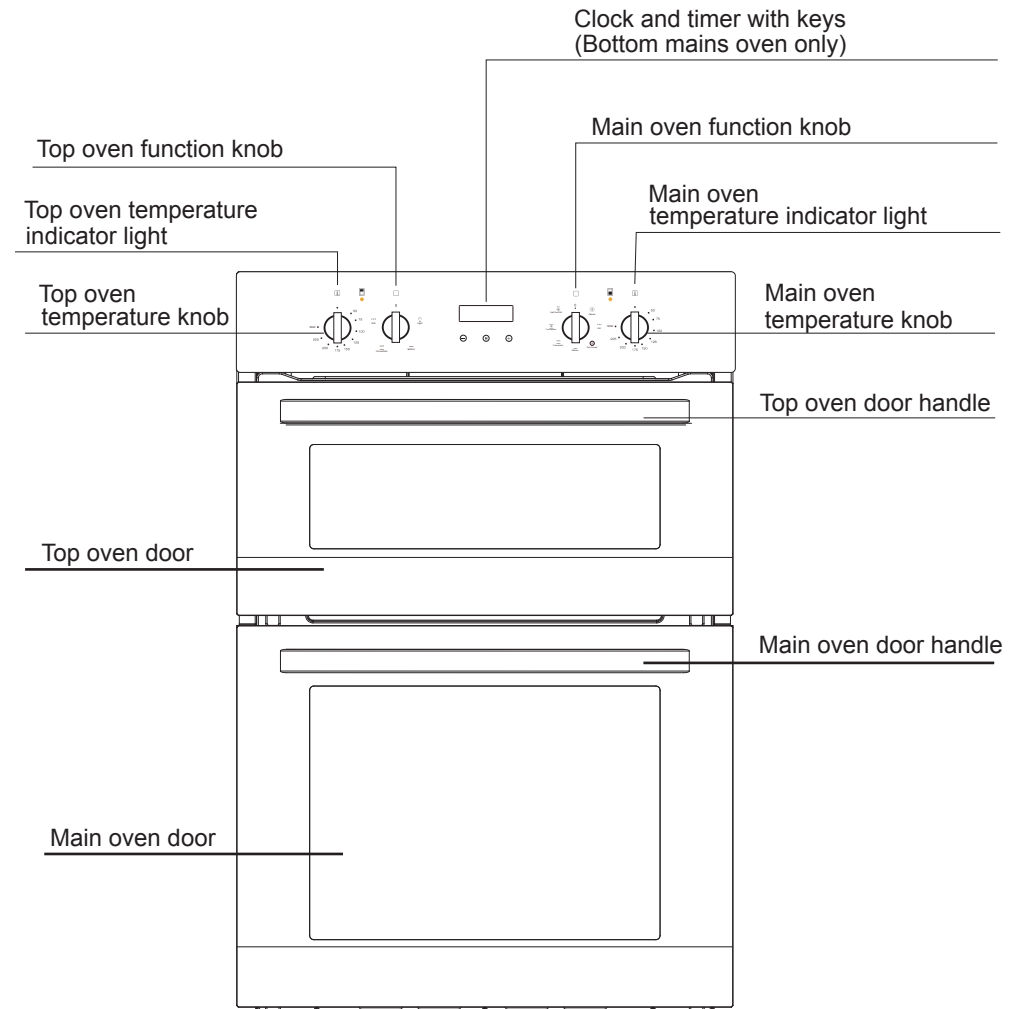

INSTALLATION

IMPORTANT

- The appliance should be installed by a QUALIFIED INSTALLATION TECHNICIAN.

The appliance must be installed in compliance with regulations in force.

You need the following housing area to fit your oven correctly.

The double oven is designed to fit into a cabinet of 600 mm width.

The double oven can be built in the kitchen units, but you must ensure that it is properly ventilated.

In the diagram the appliance is ventilated by means of the space in the top of the kitchen cabinet.

Lift the appliance into position onto the shelf, taking care NOT to lift it by the door handles.

If you open the oven doors, you will see some screw holes.

The oven should then be secured to the housing by fitting screws into these holes.

Remember the housing should not be free standing but be secured to the wall and/or adjacent fitting.

Adjust the hinges of furniture door adjacent to the double oven to allow a 5-7 mm gap between the furniture door and the oven frame.

Dimensions (mm)	Oven	Housing
Height	888	877
Width	595	565
Depth	545	555 min.

WARNING

- We would point out that the adhesive which bonds the plastic laminate to the furniture must withstand temperatures not less than 150° C to avoid delamination.
- The appliance must be housed in heat resisting units.
- The walls of the units must be capable of resisting temperatures of 75° C above room temperature.

WARNING

When correctly installed, your product meets all safety requirements laid down for this type of product category. However special care should be taken around the rear or the underneath of the appliance as these areas are not designed or intended to be touched and may contain sharp or rough edges, that may cause injury.

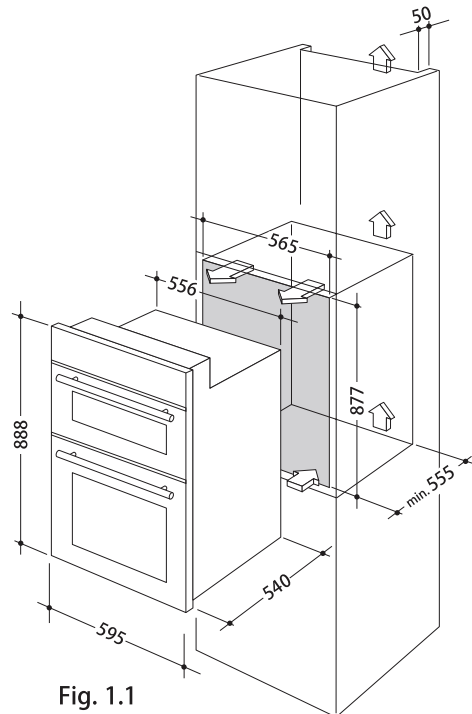

Fig. 1.1

INSTALLATION

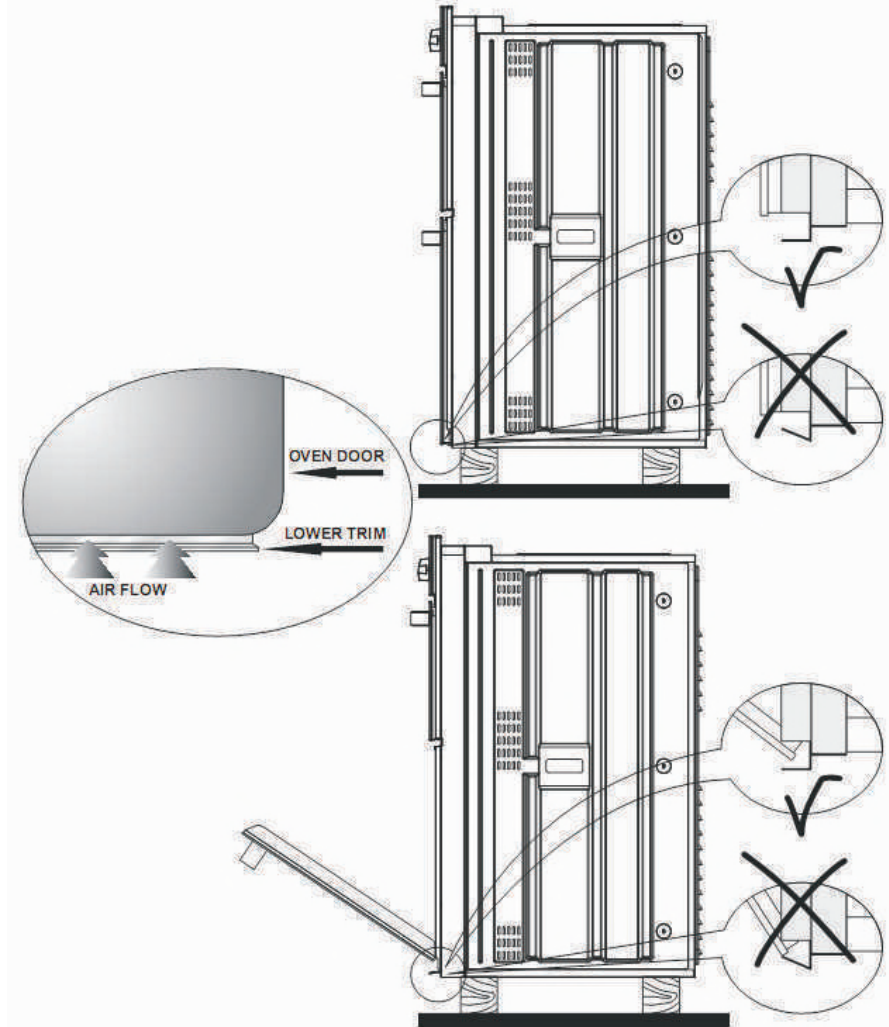

Fig. 1.2

IMPORTANT:

To avoid damage to the lower trim please note the following instructions.

The lower trim is designed to allow for good air circulation and the correct opening of the oven door.

To ensure the trim is not damaged due to the appliance being placed on the floor, the appliance should be suitably supported as in above illustrations.

After installation the appliance door should be slowly opened to ensure no damage has occurred.

No responsibility for lower trim damage will be accepted if these instructions have not been followed.

INSTALLATION

Electric connection oven

Warning!

All electrical work must be carried out by a suitably qualified and authorized electrician. No alterations or willful changes in the electricity supply should be carried out.

- Before attempting the connection, check whether the voltage indicated on the rating plate corresponds to the actual mains voltage.
- Mains lead should be minimum 1.5m long.
- Earthing wire should be installed in such manner to be the last one pulled out in case the safety relief device of the mains lead should fail.
- Mains lead behind the oven must be placed in such manner to avoid touching the back panel of the oven because of the heat it develops during operation.
- The cable of correct size rating please follow the below diagram.

CONNECTION DIAGRAM			Recommended type of connection lead
Caution! Voltage of heating elements 220-240V Caution! In the event of any connection the safety wire must be connected to the \oplus E terminal.			
1	For 220-240V earthed one-phase connection, bridges connect 1-2-3 terminals and 4-5 terminals, safety wire to \oplus .		H05VV-F 3G2.5
L=R, N=null terminal, PE=safety wire terminal			

The connection cable must be secured in a strain-relief clamp. For the connection leads, the grounding wire must be longer than the other wires.

Caution!

Remember to connect the safety circuit to the connection box terminal marked with \oplus . The electricity supply for the oven must have an all-pole disconnection switch which enables the power to be cut off in case of emergency. The distance between the working contacts of the safety switch must be at least 3 mm.

Before connecting the cooker to the power supply it is important to read the information on the manual.

OPERATION

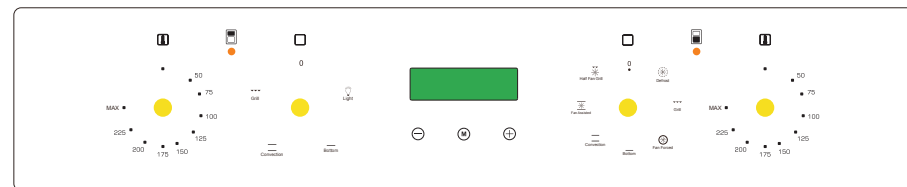

**CAO888B
CAO888W
CAO888X/1**

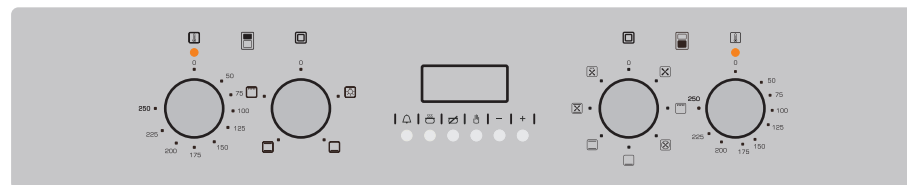

CAO888X

Top Natrual Convection

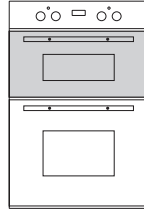

GENERAL FEATURES

This oven features 2 different thermostatic control functions to satisfy all cooking requirements, provided by 3 heating elements:

- Upper element, 850W
- Lower element, 1150W
- Grill element, 1100W

NOTE:

When using for the first time, you are advised to operate the oven at maximum temperature(thermostat knob on the maximum position) for approximately one hour in the mode and for another

15 minutes in the mode in order to eliminate any traces of grease from the electrical elements.

WARNING:

The door is hot, use the handle. During use the appliance becomes hot. Care should be taken to avoid touching heating elements inside the oven.

OPERATING PRINCIPLES

Heating and cooking in the natural convection oven are obtained:

- by natural convection
The heat is produced by the upper and lower heating elements.
- by radiation
The heat is radiated by the infrared grill elements.

Attention: The oven door becomes very hot during operation. Keep children away.

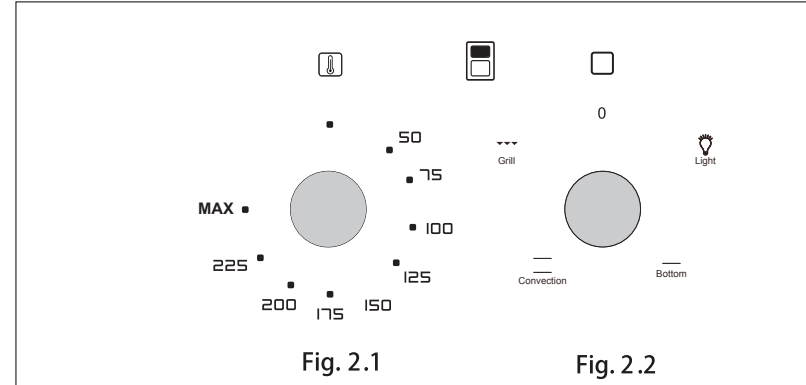

THERMOSTAT KNOB (fig.2.1)

To turn on the heating elements of the oven, set function selector knob to the required position and the thermostat knob to the desired temperature.

To set the temperature, turn the thermostat control knob indicator mark to the required temperature.

The elements will turn on or off automatically which is determined by the thermostat.

The operation of the heating elements is signalled by a light placed on the control panel.

FUNCTION SELECTOR KNOB (fig.2.2)

Rotate the knob clockwise to set the oven to one of the following functions:



By turning the function selector knob to this setting, the oven light will illuminate in the oven cavity. The oven light will operate on all selected functions.

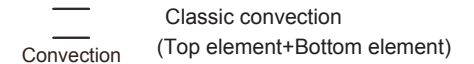

The upper and lower heating elements are switched on. The heat is diffused by natural convection and the temperature must be regulated between 50°C and the maximum position with the thermostat knob.

It is necessary to preheat the oven before introducing the foods to be cooked.

Recommended for:

For foods which require the same cooking temperature both internally and externally, i.e. roasts, spare ribs, meringue, etc.

OPERATION



Grill

Grill (Grill and the top element)

When the “combined grill” is active it enables grilling with the grill and with the top element switched on at the same time.

This function allows a higher temperature at the top of the cooking area, which causes more intense browning of the dish and permits larger portions to be grilled.

Warning!

When using function Grill it is required that the oven door is closed.



Base heat

Bottom (Bottom heater)

At this oven function knob position, the oven activates the bottom element.

OVEN COOKING

Before introducing the food, preheat the oven to the desired temperature.

For a correct preheating operation, it is advisable to remove the tray from the oven and introduce it together with the food, when the oven has reached the desired temperature.

Check the cooking time and turn off the oven 5 minutes before the theoretical time to recuperate the stored heat.

USE OF THE GRILL

Leave to warm up for approximately 5 minutes with the food closed.

Place the food inside positioning the rack as near as possible to the grill. Insert the drip pan under the rack to collect the cooking juices.

Always grill with the oven door closed.

Grill with the oven door closed and for no longer than 30 minutes at any one time.

Attention: the oven door becomes very hot during operation. Keep children away.

OPERATION

Bottom Main Multifunction Oven

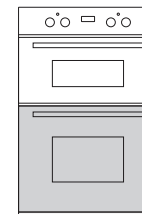

GENERAL FEATURES

The heating and cooking in electrical hot air ovens take place by forced convection.

The element which make this process take place is:

-Circular element 2000W

NOTE:

Upon first use, it is advisable to operate the oven at the maximum temperature (thermostat knob on the maximum position) for 60 minutes in the position  to eliminate possible traces of grease on the heating element.

WARNING:

The door is hot, use the handle.

During use the appliance becomes hot. Care should be taken to avoid touching heating elements inside the oven.

OPERATING PRINCIPLES

Heating and cooking in the fan oven are obtained in the following ways:

- a. by ventilation
The food is defrosted by using the fan only function without heat.
- b. by forced convection
A fan sucks in the air contained in the oven, which circulates it through the circular heating element and then forced back into the oven by the fan. Before the hot air is sucked back again by the fan to repeat the described cycle, it envelops the food in the oven, provoking a complete and rapid cooking. It is possible to cook several dishes simultaneously.

Attention: the oven door becomes very hot during operation. Keep children away.

OPERATION

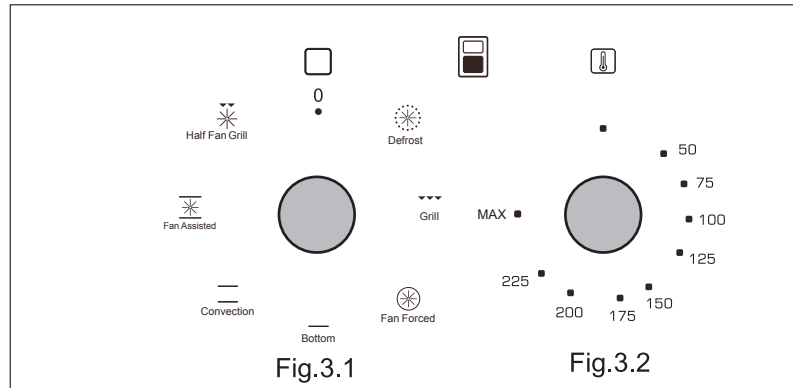

THERMOSTAT KNOB (fig. 3. 2)

To turn on the heating elements of the oven, set function selector knob to the required position and the thermostat knob to the desired temperature.

To set the temperature, turn the thermostat control knob indicator mark to the required temperature.

The elements will turn on or off automatically which is determined by the thermostat.

The operation of the heating elements is signalled by a light placed on the control panel.

FUNCTION SELECTOR KNOB

(fig.3.1)

Rotate the knob clockwise to set the oven to one of the following function:



Defrost (fan only)

Defrost

At this function, the fan only works. You can cool the dish or the oven chamber or defrost food.



Fan forced

Fan Forced

The circular element and the fan are on. The heat is diffused by forced convection and the temperature must be regulated between 50°C and the maximum position with the thermostat knob. It is not necessary to preheat the oven.

Recommended for:

For foods that must be well done on the outside and tender or rare on the inside, i.e. lasagna, lamb, roast beef, whole fish, etc.



Fan assisted

Fan Assisted

(Fan+bottom heat+Top Heat)

At this knob position the oven executes the cook function. Conventional oven with a fan.

OPERATION



Static Grill

Grill (Grill and the top element)



Classic convection

Convection (Bottom Heat+Top Heat)

When the “combined grill” is active it enables grilling with the grill and with the top element switched on at the same time.

This function allows a higher temperature at the top of the cooking area, which causes more intense browning of the dish and permits larger portions to be grilled.

The upper and lower heating elements are switched on.

The heat is diffused by natural convection and the temperature must be regulated with the thermostat knob.

It is necessary to preheat the oven before introducing the foods to be cooked.

Recommended for:

For foods which require the same cooking temperature both internally and externally, i.e. roasts, spare ribs, meringue, etc.

Warning!

When using function Grill it is required that the oven door is closed.



Base heat

Bottom (Bottom heater)

At this oven function knob position, the oven activates the bottom element.



Half Fan Grill

Half Fan Grill

When the knob is turned to this position, the oven activates the grill and fan function. In practice, this function allows the grilling process to be speeded up and an improvement in the taste of the dish, you should only use the grill with the oven door shut.

OPERATION

COOKING ADVICE

COOKING WITH FORCED AIR

Fan cooking is more economical and quicker than cooking in a conventional oven. The moving hot air surrounds the food and penetrates it more quickly than in a conventional oven.

The oven can be filled with different dishes all requiring the same cooking temperature. Subtract 10 minutes per hour for every dish requiring a cooking time of more than 1 hour and reduce the heat by 10-20°C; the hotter the oven, the more the temperature can be reduced.

Generally, there is no need to pre-heat the oven, but it is advisable to pre-heat for about 5 minutes to ensure the best results; use the indicator light as a guide, it goes out when the set temperature is reached.

Fan cooking is ideal for gelatine based dishes and softening ice cream - a microwave oven is much too strong for these dishes. Cooking yeast based dishes is also speeded up this way. If the oven door has been opened, the oven quickly regains its temperature once the door is closed.

STERILIZATION

Sterilization of foods to be conserved, in full and hermetically sealed jars, is done in the following way:

- Set the switch to position .
- Set the thermostat knob to position 175°C and preheat the oven.
- Fill the dripping pan with hot water.
- Set the jars onto the dripping pan making sure they do not touch each other and the door and set the thermostat knob to position 125°C.

When sterilization has begun, that is, when the contents of the jars start to bubble, turn off the oven and let cool.

REGENERATION

Set the switch to position  and the thermostat knob to position 150°C. Bread becomes fragrant again if wet with a few drops of water and put into the oven for about 10 minutes.

ROASTING

To obtain classical roasting, it is necessary to remember:

- that it is advisable to maintain a temperature between 180 and 200°C.
- that the cooking time depends on the quantity and the type of foods.

COOKING DIFFERENT DISHES AT THE SAME TIME

With the function selector in position , the ventilated oven allows you to cook different types of food at the same time. Fish, cakes and meat can be cooked together without the smells and flavours mixing.

The only precautions required are the following:

- The cooking temperatures must be as close as possible with a maximum difference of 20° - 25°C between the different foods.
- Different dishes must be placed in the oven at different times according to the cooking time required for each one. This type of cooking obviously provides a considerable saving on time and energy.

OPERATION

▷ Prior first use

- Remove packaging, clean the interior of the oven.
- Take out and wash the oven fittings with warm water and a little washing-up liquid.
- Switch on the ventilation in the room or open a window.
- Heat the oven (to a temperature of 250°C, for approx. 30min.) remove any stains and wash carefully.

Caution!



When heating the oven for the first time, it is normal phenomenon to give off smoke and peculiar smell. This will disappear about 30 min later.

▷ Electronic programmer

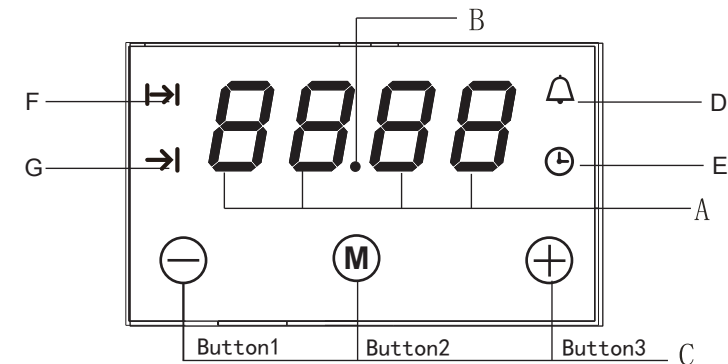
(Only for Bottom main oven)



- A - Display field
- B - Seconds Icon
- C - Buttons
- D - Timer
- E - Current time

- F - Cooking time
- G - End of cooking time
-  - Function
-  - To decrease the numbers on the digital display
-  - To increase the numbers on the digital display

OPERATION

Setting the time

- At power on, displays "12.00", and  flashes.

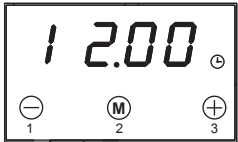

- The current time can be set with button 1 and 3, 5 seconds after the time has been set, the new data will be saved.

Timer

The timer can be activated at any time and any function. The timer can be set from 1 minute to 23 hours and 59 minutes.

To set the timer you should:

- Press button 2, flashing . Enter the timer setting.

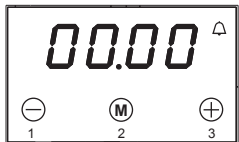

- Set the timer using buttons 1 and 3.

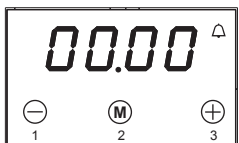

- 5 seconds after the time is set, or directly press button 2, the signal function  is on. Your setting is saved.



- When the set time is up the alarm signal will be activated and the signal function  starts flashing again.



- Press any button, the signal function  and alarm signal will go off. Or the alarm signal will be turned off automatically after 2 minutes.



OPERATION

Caution!

Apart from the timer alarm, any other alarms can be turned off by pressing any button, If the alarm signal is not turned off manually, it will be turned off automatically after 2 minutes.

Semi-automatic operation

If the oven is to be switched off at a given time, or after defined period, you should:

- Set the oven function knob and the temperature regulator knob to the setting at which you want the oven to operate.
- Press the function button, the oven will begin to work and the function signal  flashing.
- Press button 1 or 3 to adjust the cooking time, within a range from 1 minute to 10 hours.
- Or press button "M" twice. then the display will show flashing . Set the end time by buttons 1 and 3.
- The set time is memorised after 5 seconds.
- When the set time is up, the oven is switched off automatically, the alarm is activated.
- Press any button, the alarm signal and the  icon will go off, Or the alarm signal will be turned off automatically after 2 minutes.

Caution!

- The cooking time and end of cooking time range:
Cooking time range: $0 < t \leq 10$ hours
End of cooking time range: current time < end of cooking time \leq current time + 10 hours
End of cooking time = current time + cooking time
- When using the semi-automatic operation, set either the cooking time or the end of cooking time.
- If you set the cooking time to 0 or set the end of cooking time to the current time, the auto function will be off.
- After the auto function switches off, the cooking time to 0, end of cooking time and current time remains the same.

For example:

The current time is 2:00, and you want the oven to work for 3 hours, end of cooking time is set to be 5:00 ($2:00 + 3:00 = 5:00$).

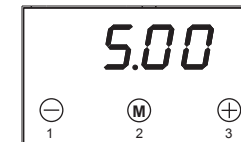

There are two methods to achieve this setting:

First method:

- Set the cooking time using buttons 1 and 3.

OPERATION

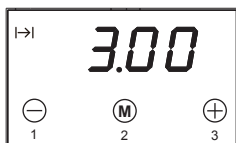

- End of cooking time automatically changes to 5:00.

Second method:

- Set the end of cooking time using buttons 1 and 3.

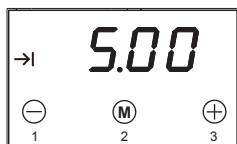

- Cooking time automatically changes to 3:00. 5 seconds after setting, the auto function is on. 3 hours later, the current time shows "5.00" The alarm signal is activated.

Automatic operation

If the oven is to be switched on for a specified period of time and switched off at a fixed hour then you should set the cooking time and the end of cooking time:

- Set the oven function knob and the temperature regulator knob to the setting at which you want the oven to operate.
- Press button 2, the oven will begin to work and the function signal I->I flashing.
- Press button 1 or 3 to adjust the cook time, within a range from 1 minute to 10 hours.
- Press button 2. then the display will show flashing ->I. Set the cooking time using buttons 1 and 3.
- The set time is introduced to the memory after 5 seconds, the I->I and ->I always on.
- When the set time passed, the oven is switched off automatically, the alarm is activated. and the I->I will go off.
- Press any button, the alarm signal and the ->I icon will go off, Or the alarm signal will be turned off automatically after 2 minutes.

OPERATION

Caution!

- Work time = end of cooking time - cooking time

For example:

If the current time is 2:00; cooking time set to be 3 hours; end of cooking time set to be 10:00, the work time will be 7:00 (7:00=10:00-3:00).



- Set the cooking time to be "3.00" with buttons 1 and 3.



- Set the end of cooking time. time to be "10.00" with buttons 1 and 3.



- 5 seconds after setting, the auto function is on.



- When it up to 7:00, the oven will begin to work.

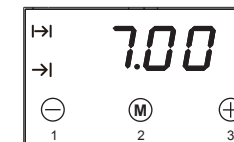

- When it up to 10:00, the alarm signal is activated. The oven is switched off automatically.

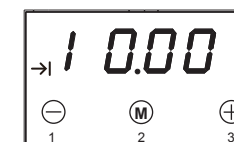

Caution!

- End of cooking time > current time + cooking time <= 10hours
- At least more than one minute cooking time, cooking time and end of cooking time must be set.
- If the cooking time set to be 0 or the end of cooking time set to be the current time, the auto function will be off.
- After the auto function switches off, the cooking time returns to 0, end of cooking time and current time remain the same.

OPERATION

▶ Electronic programmer (Only for CAO888X)

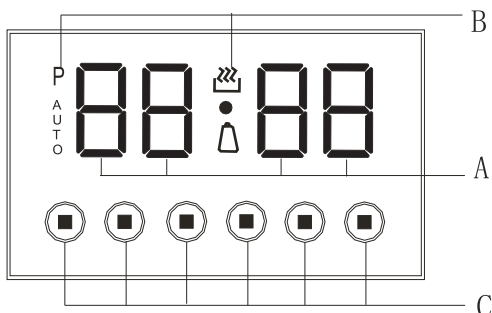

A- Display field

B- Functions

 - Automatic operation indication

 - Cooking indication

 - Running indication

 - Timer

C - Buttons

 - Timer

 - Cooking time

 - End of cooking time

 - Manual position and cancellation of the set cooking programme

 - To decrease the numbers on the digital display

 - To increase the numbers on the digital display

OPERATION

Caution!

Before any setting, press button 4 to start the oven.

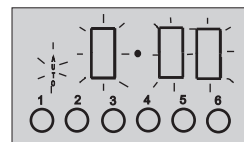

Setting the time

1. After connection to the mains or reconnection after a power cut, the display shows flash "0:00" and .

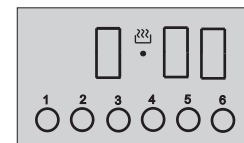

2. Press button 4, the signal function  is on.



3. The signal function  been flashing, set the current time using buttons 5 and 6. 5 seconds after the time has been set, the new data will be saved. The signal function  is on.

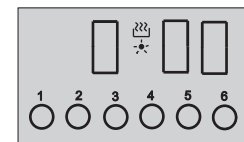

Timer

The timer can be activated at any time and any function. The timer can be set for from 1 minute to up to 23 hours and 59 minutes.

To set the timer you should:

1. Press button 1, the display will show

"0.00" and flashing .

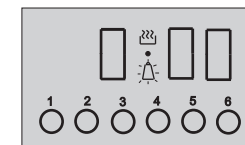

2. Set the timer using buttons 5 and 6.

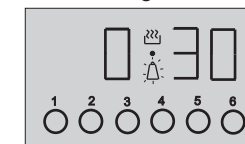

3. 5 seconds after the time is set, the signal function  is on. The new data will be save and the display will show the current time.

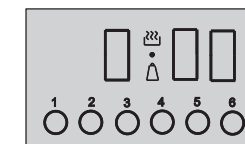

4. Press button 1, the remanent time will be shown on the the display. (In the last minute, the display will show the seconds)

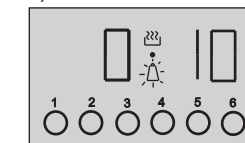

If you want to reset the timer, repeat step 2 and set time to 0:00.

5. When the set time is up the alarm signal will be activated and the signal function  starts flashing again.

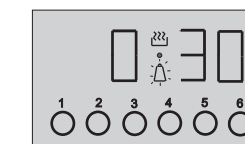

OPERATION

6. Press any button, the signal function



 and alarm signal will go off. If the alarm signal is not turned off manually, it will be turned off automatically after 7 minutes.

Caution!

Beside timer alarm, any other alarms can be turned off by pressing buttons 1, 2, 3 or 4. If the alarm signal is not turned off manually, it will be turned off automatically after 7 minutes.

Semi-automatic operation

If the oven is to be switched off at a given time, or after a defined period, you should:

1. Set the oven function knob and the temperature regulator knob to the setting at which you want the oven to operate.
2. Press button 4, the oven will begin to work and the function signal  is on.
3. Press button 2 or 3, then the display will show flashing .
4. Set the required time using buttons 5 and 6, within a range from 1 minute to 10 hours.
5. The set time is introduced to the memory after 5 seconds, then the display will show the current time. At the same time, the function signal  is on.
6. When the set time has passed, the oven is switched off automatically, the alarm is activated, the signal function

 is off, and the signal function

 starts flashing again.

7. Press buttons 1, 2, 3, the alarm signal will go off. If you press button 4, the alarm signal and  signal will all go off. Or if the alarm signal is not turned off manually, it will be turned off automatically after 7 minutes.

Caution!

- The cooking time and switch-off time range:
Cooking time range: $0 < t \leq 10$ hours
Switch-off time range: $\text{current time} < \text{switch-off time} \leq \text{current time} + 10$ hours

Switch-off time = current time + cooking time

- When using the semi-automatic operation, set either the cooking time or the switch-off time.
- If you set the cooking time to 0 or set the switch-off time to the current time, the auto function will be off.

For example:

The current time is 2:00, the maximum switch-off time is set to be 12:00 ($2:00 + 10:00 = 12:00$).

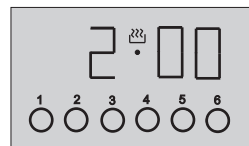

There are two methods to achieve this setting:

First method:

1. Press button 2, then the display will show flashing .

OPERATION

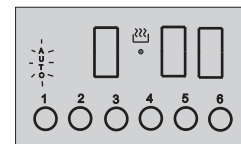

2. Set the cooking time using buttons 5 and 6.

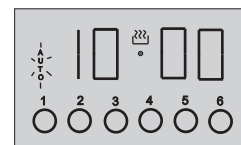

Second method:

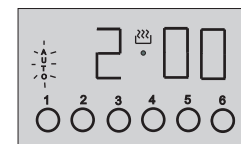

1. Press button 3, then the display will show flashing .

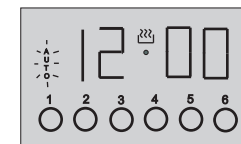

2. Set the switch-off time using buttons 5 and 6.









5 seconds after the setting, the auto function is on.

10 hours later, the current time shows "12:00". The alarm signal is activated, the signal function  is off, and the signal function  starts flashing.

Automatic operation

If the oven is to be switched on for a specified period of time and switched off at a fixed hour then you should set the cooking time and the stop time:

1. Set the oven function knob and the temperature regulator knob to the setting at which you want the oven to operate.
2. Press button 4, the oven will begin to work and the function signal  is on.
3. Press button 2, the display will show flashing . Set the cooking time using buttons 5 and 6, within a range from 1 minute to 10 hours.
4. Press button 3, set the switch-off time using buttons 5 and 6.
5. The set time is introduced to the memory after 5 seconds, then the function signal  is on. When the start time is reached, the oven will begin to work and the display will show the current time. At the same time, the function signal  is on.
6. When the set time has passed, the oven is switched off automatically, the alarm signal is activated, the signal function  is off, and the signal function  starts flashing again.
7. Press buttons 1, 2, 3, the alarm signal will go off. If you press button 4, the alarm signal and  signal will all go off. Or if the alarm signal is not turned off manually, it will be turned off automatically after 7 minutes.

OPERATION

Caution!

- Work time = switch-off time - cooking time

For example:

If the current time is 2:00; cooking time set to be 3 hours; switch-off time set to be 10:00, the work time will be 7:00 (7:00=10:00-3:00).

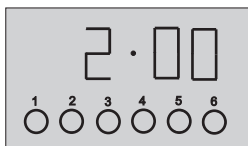

1. Press button 4, the oven begin to work, and the signal function  is on.

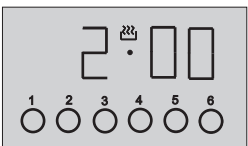

2. Press button 2, then the display will show flashing  .

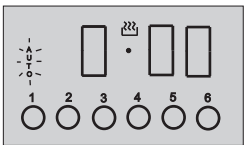

3. Set the cooking time to be "3.00" with buttons 5 or 6.

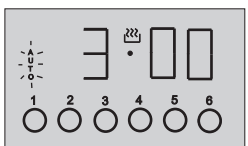

4. Press button 3.

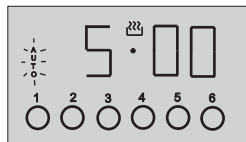

5. Set the switch-off time to be "10.00" with buttons 5 or 6. the signal function  goes out.

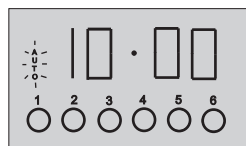

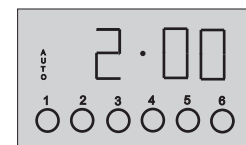

6. 5 seconds after setting, the auto function  is on.

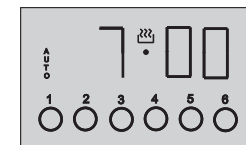

7. When it up to 7:00, the oven will begin to work and the signal function  is on.



OPERATION

8. When it up to 10:00, the alarm signal is activated, the signal function  is off, and the signal  starts flashing.

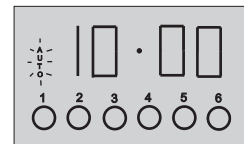

- If the cooking time set to be 0 or the switch-off time set to the current time, the auto function will be off.

Cancel settings cancel automatic function

Press button 2 and 3 simultaneously or button 4, the auto function will be cancelled, and the function signal  will go out. Then the display will show the current time.

Cancel timer settings

Press button 1 to select timer settings, and then press button 5 set time to 0:00, 5 seconds later, timer is cancelled.

OPERATION

Top Oven guide levels

Baking pans and accessories(oven grid, baking tray, etc) may be inserted into the oven in 5 guiding levels. Appropriate levels are indicated in the tables that follow. Always count levels from the bottom upwards!

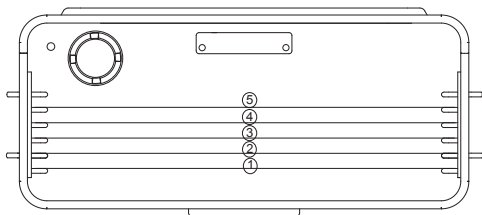

Bottom main Oven guide levels

Baking pans and accessories (oven grid, baking tray, etc) may be inserted into the oven in 5 guiding levels. Appropriate levels are indicated in the tables that follow. Always count levels from the bottom upwards!

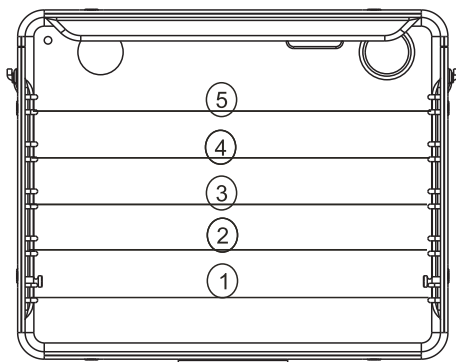

CLEANING AND MAINTENANCE

By ensuring proper cleaning and maintenance your oven you can have a significant influence on the continuing fault-free operation of your appliance.

Before you start cleaning, the oven must be switched off and you should ensure that all knobs are set to the "0" position. Do not start cleaning until the oven has completely cooled.

▷ Oven

- The oven should be cleaned after each use.
- Cool the oven completely before cleaning.
- Never clean the appliance with pressurized hot steam cleaner.
- The oven chamber should only be washed with warm water and a small amount of washing-up liquid.

● Steam cleaning

-pour 250ml of water(1 cup) into a bowl placed in the oven on the first level from the bottom.

-Close the oven door.

- Set the function knob to the 100°C and the function knob to the bottom heater position.

-Heat the oven chamber for approximately 30 minutes.

-Open the oven door, wipe the chamber inside with a cloth or sponge and wash using warm water with washing-up liquid.

- After cleaning the oven chamber wipe it dry.

Caution!

Do not use cleaning products containing abrasive materials for the cleaning and maintenance of the glass front panel.

▷ Replacement of the oven light Bulb

Before any maintenance is started involving electrical parts, the appliance must be disconnected from the power supply. If the oven has been in use, let the oven cavity and the heating elements cool down before attempting any maintenance.

Changing the bulb

- Unscrew the protective cover. We recommend that you wash and dry the glass cover at this point.
- Carefully remove the old bulb and insert the new bulb suitable for high temperatures (300°C) having the following specifications: 220-240V, 50-60Hz, 25W , G9 fitting.
- Refit the protective cover.

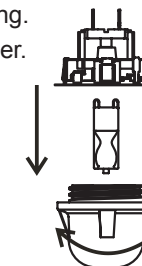

IMPORTANT

Never use screwdrivers or other utensils to remove the light cover. This could damage the enamel of the oven or the lampholder. Remove only by hand.

IMPORTANT

Never replace the bulb with bare hands as contamination from your fingers can cause premature failure. Always use a clean cloth or gloves.

Please note:

The bulb replacement is not covered by your guarantee

CLEANING AND MAINTENANCE

▷ Door removal

In order to obtain easier access to the oven chamber for cleaning, it is possible to remove the door.

To do this, tilt the safety catch part of the hinge upwards. Close the door lightly, lift and pull it out towards you. In order to fit the door back on to the cooker, do the reverse. When fitting, ensure that the notch of the hinge is correctly placed on the protrusion of the hinge holder. After the door is fitted to the oven, the safety catch should be carefully lowered down again. If the safety catch is not set it may cause damage to the hinge when closing the door.

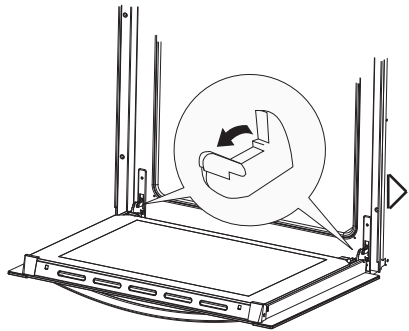

Tilting the hinge safety catches

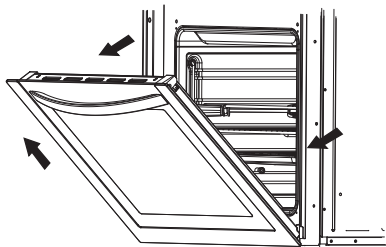

Door removal

▷ Removal of the internal glass panel

Unscrew and unfasten the plastic latch that is in the corner at the top of the door. Next take out the glass from the second blocking mechanism and remove. After cleaning, insert and block the glass panel, and screw in the blocking mechanism.

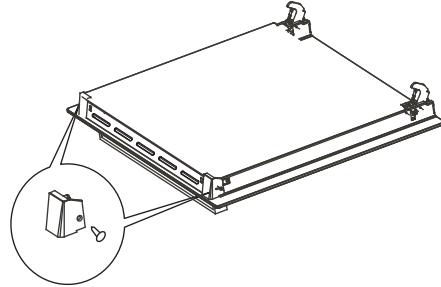

Removal of the internal glass panel

▷ Install door

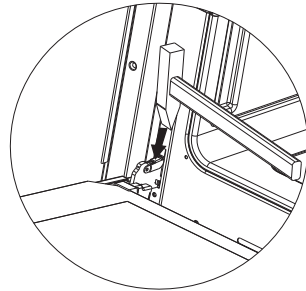

CLEANING AND MAINTENANCE

▷ Models With Wire Racks

- Assemble the wire racks to the oven walls using the 2 screws(fig.4.1-4.2)
- Slide in, on the guides, the shelf and the tray(fig.4.3-4.4).

The shelf must be fitted so that the safety catch, which stops it sliding out, faces the inside of the oven.

- To dismantle, operate in reverse order.

Top oven

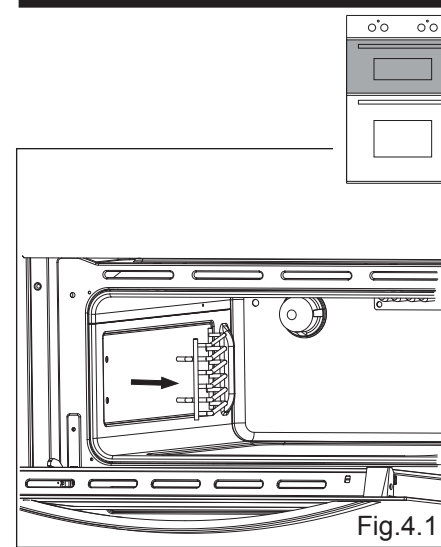

Fig.4.1

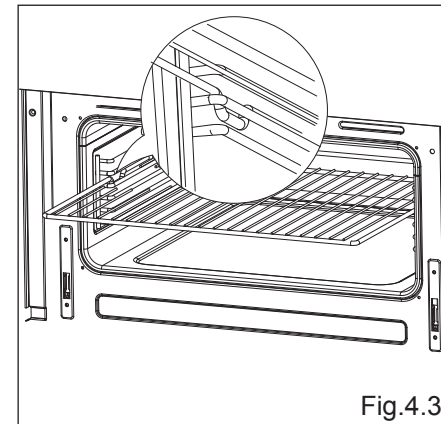

Fig.4.3

Bottom main oven

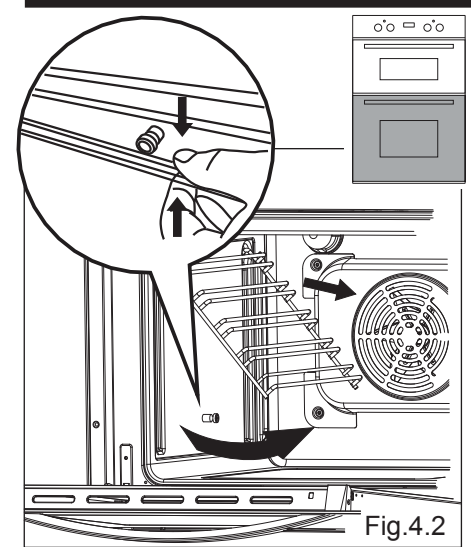

Fig.4.2

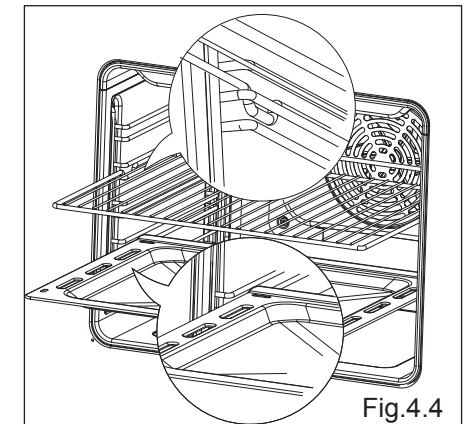

Fig.4.4

OPERATION IN CASE OF EMERGENCY

In the event of an emergency, you should:

- Switch off all working units of the oven
- Call the service centre
- Some minor faults can be fixed by referring to the instructions given in the table below. Before calling the customer support centre or the service centre check the following points that are presented in the table.

PROBLEM	REASON	ACTION
1. The appliance does not work.	Break in power supply.	Check the household fuse box; if there is a blown fuse replace it with a new one
	Choose wrong function.	Check if function knob, temperature knob are set to the correct position.
2. The programmer display is flashing "0.00".	The appliance was disconnected from the mains or there was a temporary power cut.	Set the current time(see Use of the programmer)
3. The oven lighting does not work.	The bulb is loose or damaged.	Tighten up or replace the blown bulb (see 'Cleaning and Maintenance')

BAKING IN THE OVEN

▷ Baking pastry

Most appropriate position for baking is the hot air.

Warning!

- The baking parameters given in Tables are approximate and can be corrected based on your own experience and cooking preferences;
- In case you may not find any particular type of cake in the tables, use the information available for the next most similar type of cake.

Baking with upper and lower elements

- Use only a single guide level.
- This baking position is especially suitable for baking dry pastry, bread and teacakes. Use dark baking pans. Light pans reflect heat and pastry is not adequately browned.
- Always place baking pans on the grid rack. Remove the grid only if baking in the flat biscuit tray, supplied with the appliance.
- Preheating shortens the baking time. Do not put the cake in the oven until proper temperature is obtained.

Baking tips

Is cake baked?

Pierce the cake with a wooden skewer at the thickest part, if the dough does not stick to it, the cake is baked. You may switch off the oven and use the remaining heat.

Cake has fallen

Check the recipe. Use less liquid next time. Follow the mixing times, especially when using electric kitchen mixers.

Cake is too light on the bottom

Use dark baking pan next time, or place the pan one level lower, or switch on the lower heater a while before the completion.

Cheese cake is undercooked

Next time reduce the baking temperature and extend the baking time.

Warnings regarding the baking tables

- The tables indicate the temperature range. Always select lower temperature first. You may always increase the temperature in case pastry needs more baking.
- Baking times are indicative only.
- The asterisk indicates that the oven requires preheating.

BAKING IN THE OVEN

Pastry Baking Table

Type of pastry	Guide level from down upwards	Temp(°C) — Convection	Guide level from down upwards	Temp(°C) * Fan Assisted	Guide level from down upwards	Temp(°C) * Fan Forced	Baking time (in min.)
Sponge cake/ marble cake	2	170-180	2	160-170	2	150-170	60-80
Victoria sponge	2	160-180			2	150-170	65-80
Base for a layer cake	2-3	170-180			2-3	150-170	20-30
Sponge layer cake	2	170-180					30-40
Fruit cake(crispy base)			3	160-170	2-3	160-180	60-70
Cheesecake(shortcrust)			3	160-170	2	140-150	60-90
Teacake	2	160-180			2	150-170	40-60
Bread(e.g.wholegrain bread)	2	210-220	3	180-210	2	150-170	50-60
Fruit cake(crispy base)	3	170-180	3	160-170	2	160-200	35-60
Fruit cake(with yeast)					2	160-170	30-50
Crumble cake	3	160-170				150-170	30-40
Sponge roll	2	180-200					10-15
Pizza(thin base)	3	220-240	3	200-220			10-15
Pizza(thick base)	2	180-210	3	210-230			30-50
Puff pastry	3	180-190	3	160-170	2	170-190	18-25
Meringues	3	90-110					80-90
Choux buns					2	170-190	35-45

BAKING IN THE OVEN

Roasting

Tip regarding roasting pans

- For best results, use light enamel pans, temperature resistant glass pans, clay dishes or cast iron dishes.
- As stainless steel dishes reflect the heat, they are not recommended.
- If you cover your roast or wrap it in foil, it will preserve its juices and the oven will remain clean.
- The roast will be cooked quicker if it is left uncovered. Large roasts can be placed directly on the grid with the oven tray below for catching the juices and melted fat.

Attention when roasting!

Roasting tables indicate suggested temperatures, guide level and roasting times. Roasting time largely depends upon the type of meat, its size and quality. So you may expect some variations

- Roasting of large chunks of meat may produce excessive steaming and condensation on the oven door. This is quite normal, and does not affect the operation of the oven. However, after the completion of roasting wipe the oven door and the glass thoroughly.
- Add as much liquid as necessary to prevent burning of juice, dripping from meat. Roast must be checked regularly and liquid added if necessary.
- At approximately the middle of the indicated time turn the roast round, especially if you use the deep roast dish.
- When roasting on the grill grid, place the grid in the deep roasting pan and insert both into the sliding guide. The bottom pan will intercept dripping fat.
- Never leave roast to cool in the oven, as it might produce condensation and corrosion of the oven.

BAKING IN THE OVEN

Roasting table

Type of meat	Guide level (from bottom up)	Temp (°C) — Convection	Guide level (from bottom up)	Temp (°C) * Fan Assisted	Guide level (from bottom up)	Temp (°C) * Fan Forced	Roasting time (in min.)
							per 1 cm
Roast beef or fillet rare			2		3	250	12-15
oven warmed up juicy ("medium")					3	250	15-25
oven warmed up "well done"					3	210-230	25-30
oven warmed up Roast joint	2	160-180			2	200-220	120-140
Pork							
Roast joint	2	160-180	2		2	200-210	90-140
Ham	2	160-180			2	200-210	60-90
Fillet					3	210-230	25-30
VEAL	2	160-170	2		2	200-210	90-120
LAMB	2	160-180			2	200-220	100-120
VENISON	2	175-180	2		2	200-220	100-120
POULTRY							
Chicken	2	170-180			2	220-250	50-80
Goose (approx. 2kg)	2	160-180	2		2	190-200	150-180
FISH	2	175-180	2		2	210-220	50-80

BAKING IN THE OVEN

Grilling

- Take extra precautions when grilling. Intensive heat from infrared element makes the oven and the accessories extremely hot. Use protective gloves and barbecue accessories!
- Perforated roast may produce spurting of hot grease (sausages). Use long grill tongs to prevent skin burns and protect your eyes.
- Supervise the grill at all time. Excessive heat may quickly burn your food and provoke fire!
- Do not let the children in the vicinity of the grill.

Grill heater is especially suitable for the preparation of low-fat sausages, meat and fish fillets and steaks, and for browning and crisping the roast skin.

Tips for grilling

- Grilling should be carried out with the oven door closed.
- Grilling tables indicate the recommended temperature, guide levels and grilling times, which may vary according to the weight and quality of meat
- Grill element should be pre-heated for 3 minutes.
- Oil the grill grid before placing food on it, to avoid food sticking to the grid.
- Place the meat upon the grid, then place the grid upon the grease interception pan. Insert both trays into the oven guides.
- Turn the meat round after half of the grilling time has expired. Thinner slices will require only one turn, for larger chunks you might need to repeat the procedure. Always use barbecue tongs to avoid losing excessive juice from meat.
- Dark beef meat is grilled quicker than lighter pork or veal.
- Clean the grill, the oven and the accessories each time after use.

BAKING IN THE OVEN

Grill table

Type of meat for grill	Weight (in grams)	Guide level(from bottom up)	Temp(°C) ▼▼▼ Grill	Grill time (in min.)
Meat and sausages				
2 beefsteaks, rare	400	5	240	14-16
2 beefsteaks, medium	400	5	240	16-20
2 beefsteaks, well done	400	5	240	20-23
2 pork scrag fillets	350	5	240	19-23
2 pork chops	400	5	240	20-23
2 veal staeks	700	5	240	19-22
4 lamb cutlets	700	5	240	15-18
4 grill sausages	400	5	240	9-14
2 slices of meat cheese	400	5	240	9-13
1 chicken, halved	1400	3	240-250	28-33(1.side) 23-28(1.side.)
Fish				
Salmon fillets	400	4	240	19-22
Fish in aluminium foil	500	4	230	10-13
Toast				
4 slices of white bread	200	5	240	1,5-3
2 slices of whole meal	200	5	240	2-3
Toast sandwich	600	5	240	4-7
Meat/poultry				
Chicken	1000	3	180-200	60-70
Pork roast	1500	3	160-180	90-120
Pork scrag	1500	3	160-180	100-180
Pork knuckle	1000	3	160-180	120-160
Roast beef/beef fillet	1500	3	190-200	40-80

TECHNICAL INFORMATION

Model	CAO888X, CAO888B CAO888W, CAO888X/1
Top oven	
Top element	850W
Grill element	1100W
Bottom element	1150W
Top oven power	2000W
Bottom mains oven	
Top element	850W
Grill element	1100W
Bottom element	1150W
Circular element	2000W
Fan	●
Bottom mains oven power	2000W
Voltage rating	220-240V 50-60HZ

Warranty Card

artusi.com.au



Worldwide Appliances Pty Limited

A.B.N. 45868077422

Distributed by Eurolinx Pty Ltd

Office:

48-50 Moore Street, Leichhardt N.S.W 2040

Post:

Locked Bag 3000, Annandale, N.S.W 2038

P: 1300 694 583

WARRANTY REGISTRATION

Your ongoing satisfaction with your artusi product is important to us. We ask that you complete the enclosed Warranty Registration Card and return it to us so that we have a record of the artusi product purchased by you.

PRIVACY

Worldwide Appliances respects your privacy and is committed to handling your personal information in accordance with the National Privacy Principles and the Privacy Act 1988 (Cth). A copy of the Worldwide Appliances Privacy Policy is available at www.artusi.com.au. Worldwide Appliances will not disclose any personal information set out in the Warranty Registration Card ("Personal Information") without your consent unless required by:

1. law;
2. any Worldwide Appliances related company;
3. any service provider which provide services to artusi or assist artusi in providing services (including repair and warranty services) to customers. Our purpose in collecting the Personal Information is

to keep a record of the artusi product purchased by you, in order to provide a better warranty service to you in the unlikely event that there is a problem with your artusi product. Worldwide Appliances may contact you at any one or more of the address, email address or telephone numbers set out in the Warranty Registration Card. Please contact artusi on 1300 694 583 should you not wish to be contacted by Worldwide Appliances.

WARRANTY

1. Warranty

Worldwide Appliances warrants that each artusi product will remain, for a period of either 12 months or 24 months of warranty. All Warranties are valid from the original date of purchase, And warranty claims must be accompanied by the proof of purchase.

24 months warranty products:

All Built-in Appliances – Limited to Ovens, Gas, Induction and Electric Cooktops, and All Rangehoods. Freestanding Cookers - Gas and Electric Models (900mm Width).

Dishwashers - Freestanding, Fully Integrated, Semi Integrated and built-in. All Wine coolers. All Dryers. Freestanding Cookers - Gas and Electric Models in 50cm, 54cm and 60cm Widths

Portable Appliances* – Benchtop Models and Portable Gas Models

2. What is not Covered by the Warranty.

The Warranty does not apply if an artusi product is defective by a factor other than a defect arising in the manufacture of the artusi product, including but not limited to:

- (a) damage through misuse (including failure to maintain, service or use with proper care), neglect, accident or ordinary wear and tear (including deterioration of parts and accessories and glass breakage);
- (b) use for purpose for which the artusi product was not sold or designed;
- (c) use or installation which is not in accordance with any specified instructions for use or installation;
- (d) use or operation after a defect has occurred or been discovered;
- (e) damage through freight, transportation or handling in transit (other than when Worldwide Appliances is responsible);
- (f) damage through exposure to chemicals, dusts, residues, excessive voltage, heat, atmospheric conditions or other forces or environmental factors outside the control of Worldwide Appliances;
- (g) repair, modification or tampering by the purchaser or any person other than Worldwide Appliances, an employee of Worldwide Appliances or an authorised artusi service contractor*;
- (h) use of parts, components or accessories which have not been supplied or specifically approved by artusi.

(i) damage to surface coatings caused by cleaning or maintenance using products not recommended in the artusi product handbook provided to the purchaser upon purchase of the artusi product;

(j) damage to the base of an electric oven due to items having been placed on the base of the oven cavity or covering the base, such as aluminium foil (this impedes the transfer of heat from the element to the oven cavity and can result in irreparable damage); or

(k) damages, dents or other cosmetic imperfections not affecting the performance of the artusi in respect of an artusi product purchased as a "factory second" or from display

The Warranty does not extend to light globes used in artusi products.

3. Domestic Use

Each artusi product is made for domestic use. This Warranty may not extend to artusi products used for commercial purposes.

Continued over...

Warranty Card continued

artusi.com.au

4. Time for Claim under the Warranty

You must make any claim under this Warranty within twenty eight (28) days after the occurrence of an event which gives rise to a claim pursuant to the Warranty, by booking a service call on the telephone number below.

5. Proof of Purchase

Customers must retain proof of purchase in order to be eligible to make a warranty claim in respect of an artusi product.

6. Claiming under the Warranty

Customers will bear the cost of claiming under this Warranty unless Worldwide Appliances determines the expenses are reasonable, in which case the customer must claim those expenses by providing written evidence of each expense to Worldwide Appliances at the address on the Warranty Registration Card.

7. Statutory Rights

(a) These terms and conditions do not affect your statutory rights.

(b) The limitations on the Warranty set out in this document do not exclude or limit the application of the consumer guarantees set out in the Act or any other equivalent or corresponding legislation in the relevant jurisdiction where to do so would:

(i) contravene the law of the relevant jurisdiction; or

(ii) cause any part of the Warranty to be void.

(c) Worldwide Appliances excludes indirect or consequential loss of any kind (including, without limitation, loss of use of the artusi product) and (other than expressly provided for in these terms and conditions) subject to all terms, conditions and warranties implied by custom, the general law, the Act or other statute.

(d) The liability of Worldwide Appliances to you

for a breach of any express or non-excludable implied term, condition or warranty is limited at the option of Worldwide Appliances to:

(i) replacing or repairing the defective part of the artusi product;

(ii) paying the cost of replacing or repairing the defective part of the artusi product;

(iii) replacing the artusi product; or

(iv) paying the cost of replacing the artusi product.

(e) Our goods come with guarantees that cannot be excluded under the Australian Consumer Law. You are entitled to a replacement or refund for a major failure and for compensation for any other reasonably foreseeable loss or damage. You are also entitled to have the goods repaired or replaced if the goods fail to be of acceptable quality and the failure does not amount to a major failure.

8. Defects

Any part of an artusi product deemed to be defective and replaced by Worldwide Appliances is the property of Worldwide Appliances. Worldwide Appliances reserves the right to inspect and test artusi products in order to determine the extent of any defect and the validity of a claim under the Warranty.

All warranty service calls must be booked via the customer care department. The team can be contacted on 1 300 85 64 11 option 1 or customercare@eurolinx.com.au

01082016



Warranty Card tear off

WARRANTY REGISTRATION CARD
01052016

Please complete and send to ARTUSI at: REPLY PAID 83617
LEICHHARDT NSW 2040

Last Name:		First Name:	
Address:			
State:	Postcode:	Email:	
Home Phone:		Mobile:	
Purchase Date: / /		(Please attach proof of purchase to validate warranty)	

MODEL NUMBER	SERIAL NUMBER (if you cannot locate the serial number please call ARTUSI on 1300 856 411)
1	
2	
3	
4	

01082016