

CAGH600CIX

60cm gas cooktop



CAGH600CIX 60cm gas cooktop with Flame Failure

580W x 500D x 90H
CUTOUT: 577W x 477D

1x wok:	3.8 kW/hr	13.3 MJ/hr
1x auxiliary:	1.0 kW/hr	3 MJ/hr
2x semi-rapid:	1.75 kW/hr	5.25 MJ/hr
TOTAL:	8.3 kW/hr	24.9 MJ/hr

- topmount
- 4 gas burners, including wok
- stainless steel
- cast-iron trivets and burner caps
- Flame Failure device fitted to each burner
- automatic electronic ignition

3-pin plug and cord: 10 amp GPO required



EAN 9347777002235

DISCLAIMER

Eurolinx PTY LTD is continually seeking ways to improve the design specifications, aesthetics and production techniques of its products. As a result alterations to our products and designs take place continually. Whilst every effort is made to produce information and literature that is up to date, this brochure should not be regarded as an infallible guide to the current specifications, nor does it constitute an offer for the sale of any particular product. Product dimensions indicated in our literature is indicative only. Actual product only should be used to define dimension cutouts. Distributors, and retailers are not agents of Eurolinx and are not authorized to bind Eurolinx by any express or implied undertaking or representation.

AR060818

CAGH600CIX

60cm gas cooktop

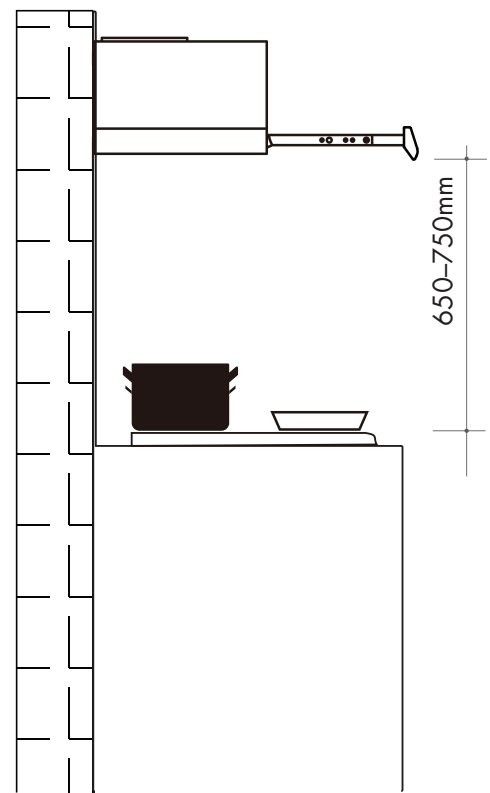
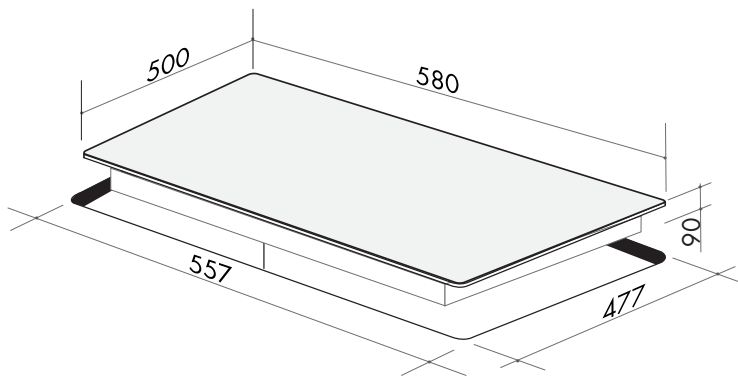

NB: drawings are not to scale — they are to be used. For detailed installation instructions, please refer to user guide.

Australia National Telephone Number 1300 694 583 New Zealand Telephone Number 0508 458 369
 ARTUSI showrooms are open Tuesday to Friday from 9am-5pm and Saturdays 10am-4pm

artusi.com.au

NSW & ACT
(head office)

48 Moore Street
Leichhardt
02 8569 4699

VIC | SA

1211 Toorak Road
CAMBERWELL
03 9809 2155

TASMANIA

Crisp Ikin
3 Pear Avenue
DERWENT PARK 7009
03 6272 7386

QLD

1/42 Cavendish Road
COORPAROO
07 3397 0850

WA | NT

10/55 Howe Street
OSBORNE PARK
08 9201 9188

New Zealand

PO Box 11.160
Sockburn Christchurch
03 344 5913