

AGH90XFFD 90cm gas cooktop



SIZE mm	909W x 522D x 50H CUTOUT: 840W x 480D	
FINISH	stainless steel	
CAPACITY	2 x wok:	3.5 kW/hr
	1x auxiliary:	1.0 kW/hr
	2x semi-rapid:	1.75 kW/hr
	rapid:	3.1 kW/hr
	TOTAL:	14.6 kW/hr



FEATURES	<ul style="list-style-type: none"> • 6 gas burners, including 2 x wok • stainless steel • cast-iron trivets, wok cradle and burner caps • flame failure device fitted to each burner • automatic electronic ignition
POWER	electrical connection 10 AMP GPO, must be hard wired



EAN 9347777000651

DISCLAIMER

Eurolinx Pty Ltd, trading as ILVE Appliances, is continually seeking ways to improve the design specifications, aesthetics and production techniques of its products. As a result alterations to our products and designs take place continually. Whilst every effort is made to produce information and literature that is up to date, this brochure should not be regarded as an infallible guide to the current specifications, nor does it constitute an offer for the sale of any particular product. Product dimensions indicated in our literature is indicative only. Actual product only should be used to define dimension cutouts. Distributors, and retailers are not agents of ILVE Appliances and are not authorized to bind ILVE Appliances by any express or implied undertaking or representation.

AGH90XFFD 90cm gas cooktop

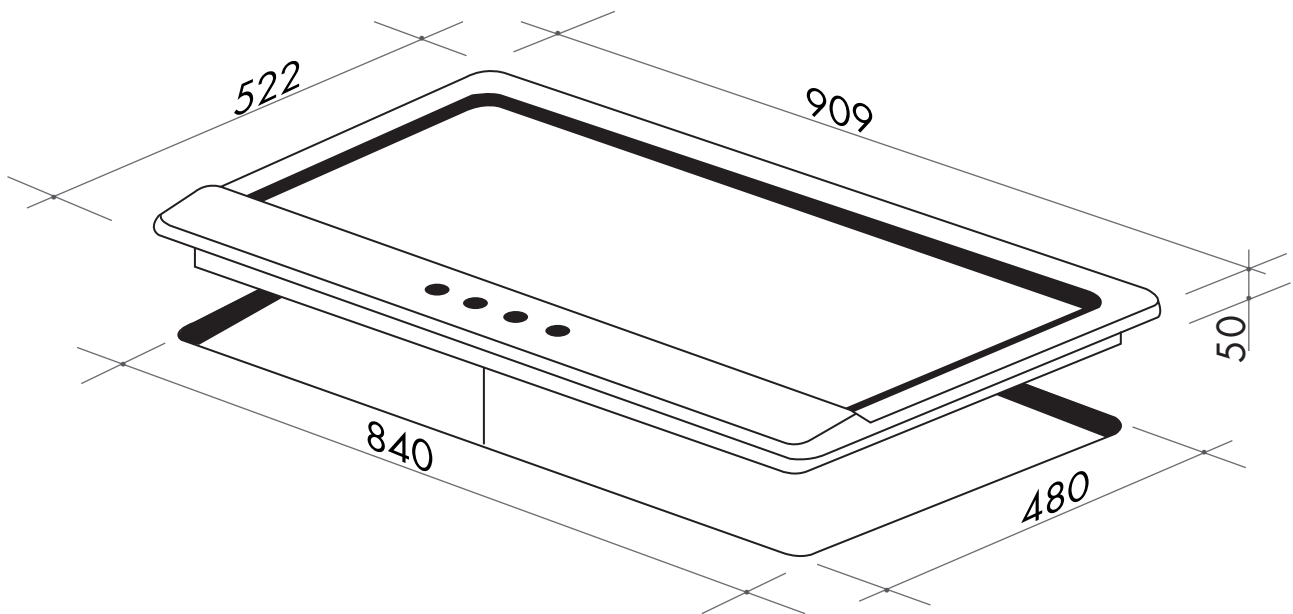

NB: drawings are not to scale — they are to be used as a guide only

Australia National Telephone Number 1300 649 583 New Zealand Telephone Number 0508 458 369
ARTUSI showrooms are open daily from 9am-5pm and Saturdays 10am-4pm

artusi.com.au

NSW & ACT (head office)

48 Moore Street
Leichhardt
02 8569 4699

VIC | TAS | SA

1211 Toorak Road
CAMBERWELL
03 9809 2155

QLD

1/42 Cavendish Road
COORPAROO
07 3397 0850

WA | NT

10/55 Howe Street
OSBORNE PARK
08 9201 9188

New Zealand

PO Box 11.160
Sockburn Christchurch
03 344 5906