

青岛兴邦电子电器有限公司

说明书

客户名称	澳大利亚ARTUSI	设计	于丽
产品型号	KH90A-F1N160	会签 型号经理	
业务经理	薛孝田	会签 电气工程师	
设计时间	2014.10.29	审核	
版次	03	批准	

印刷说明:

1.此印刷品专用号 **Cod:0103080351**

2.此印刷品自下发之日起开始实施。

3.此印刷品最终成品大小为**A4**纸一半大小。

4.此印刷品黑白印刷。

5.此印刷品要求字迹清晰、不能有漏印、错印、模糊现象。

- 工业设计工程师负责根据客户要求对版面进行设计修改;
- 型号经理负责会签确定机器尺寸/外观型号/具体参数等;
- 电气工程师负责会签确定电压/功率/接线图/认证标志等;
- 销售经理负责审核确定客户对文件是否确认;
- 技术部长负责批准确定文件是否下发;

(注:此页为非印刷页,仅为了说明)

ARTUSI

Cooker Hood

Model ACH600X ACH900X

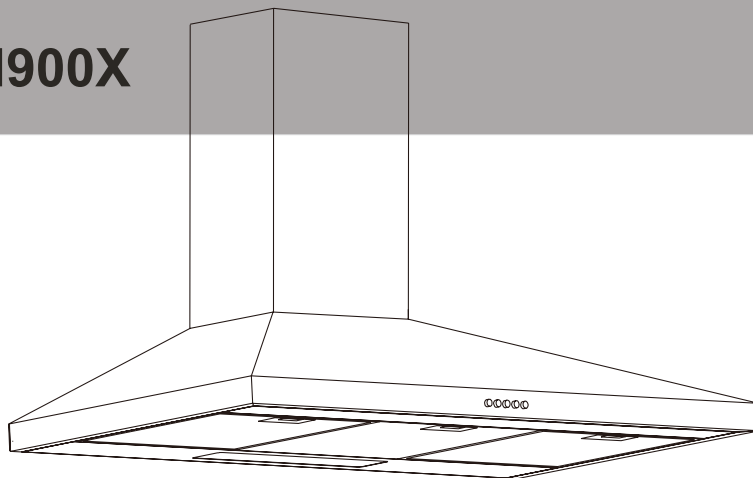

Instruction Book

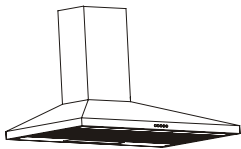

Information and advice

Specifications: 220-240V~50Hz 240W

CAUTION: Accessible parts may become hot when used with cooking appliances.

In certain circumstances electrical appliance may be a danger hazard.

- A) There shall be adequate ventilation of the room when the cooker hood is used at the same time as appliances burning gas or other fuels.
- B) Do not check the status of the filters while the cooker hood is operating.
- C) Do not touch the light bulb within half an hour after appliance use.
- D) Do not flambe under the cooker hood.
- E) Avoid opening gasometer when there is no pan on the stove , as it is damaging for the filters and a fire hazard
- F) Constantly check food frying to avoid that the overheated oil may become a fire hazard.
- G) Disconnect the electrical plug prior to any maintenance.
- H) Regulations concerning the discharge of air have to be fulfilled.
- I) When the range hood and appliances supplied with energy Other than electricity are simultaneously in operation.

The negative pressure in the room must not exceed 4 Pa (4×10^{-5} bar)



Information and advice

Specifications: 220-240V~50Hz 240W

J) This appliance is not intended for use by persons (including children) with reduced physical, sensory or mental capabilities, or lack of experience and knowledge, unless they have been given supervision or instruction concerning use of the appliance by a person responsible for their safety.

K) Attention! Observe the warning in the instruction sheet concerning the operation of the appliance when air is discharged from the room.

L) If the supply cord is damaged, it must be replaced by the manufacturer, its service agent or similarly qualified persons in order to avoid a hazard.

M) The range hood is intended to be installed over a hob having no more than four hob elements.

N) Indoor use and household use only.

O) When the appliance is not in use and before cleaning, unplug the appliance from the outlet.

P) Attention! Observe the warning in the instruction sheet concerning the operation of the appliance when air is discharged from the room.



Know your cooker hood

Please read these instructions Before using your cooker hood

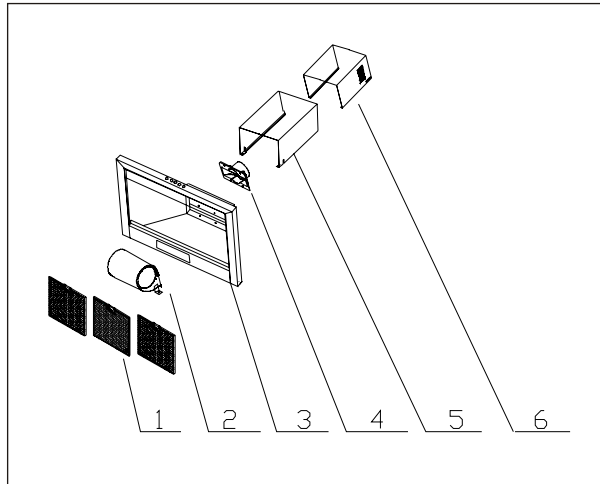

1.Filter assembly

2.Air duct assembly

3.Main body assembly

4.Damper flap

5.Outside chimney

6.Inner chimney

***Alsoincluded**

*** Damper flap**

*** Chimney fixed bolster**

***Drill hole stencil**

***User instructions**



Information

Congratulations on the purchase of our Cooker hood, which is designed to include many superior features that permit you the fullest expression of your living. Before installing and/or using the cooker hood carefully read all the instructions.

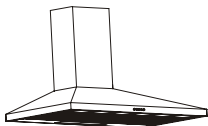

Information and advice

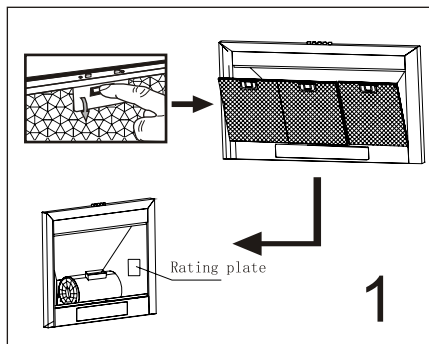

Check voltage and Frequency given on the rating plate located on the inside of the hood.

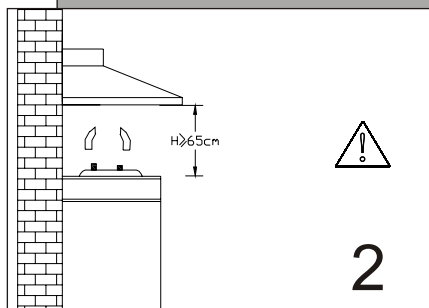

We recommend that after installation the bottom of the hood should be no less than 650mm and no more than 750mm above the stove's heating elements and burners.



Information

The air must not be discharged into a flue that is used for exhausting fumes from appliances burning gas or other fuels (not applicable to appliances that only discharge the air back into the room)

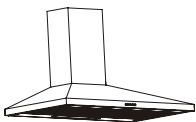

Installation

Ensure the power has been turned off before beginning this installation.

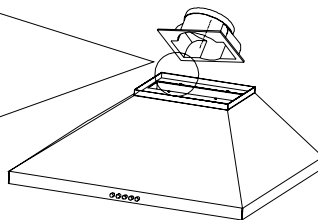
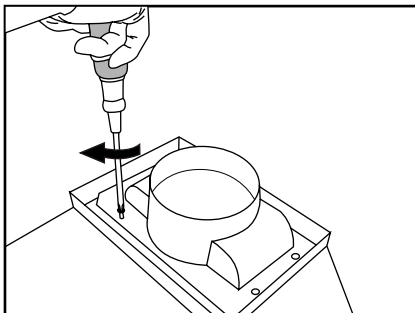

3

Before installing the cooker hood, please first fix the damper flap on the air outlet of the hoods.



Information

Connect universal hose, easy selecting the venting direction

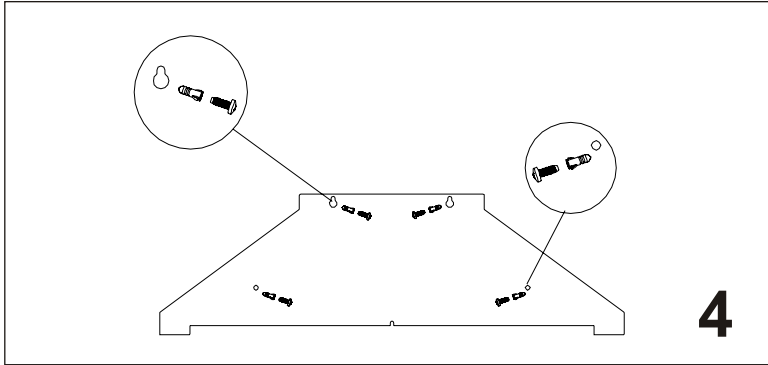

According to the Fig.4, make sure the position of the hoods on the wall. Then use the stencil to drill four $\Phi 8$ holes on the wall. Fix four sets expanding plugs and screws aimed at the four holes.

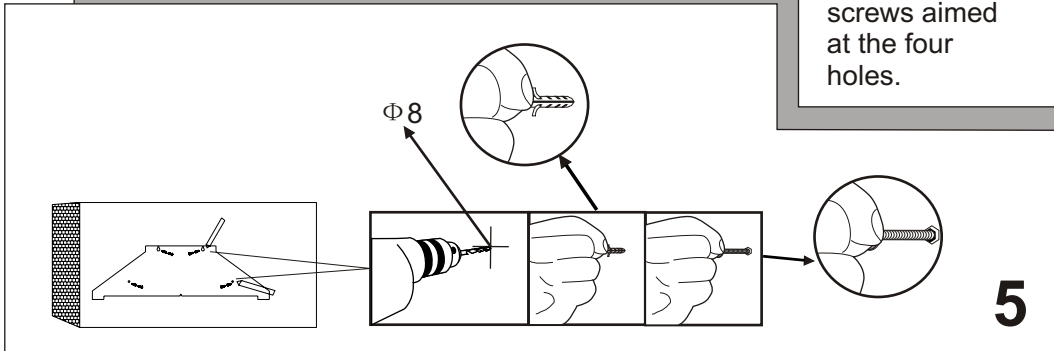

Information

When cutting or drilling or ceiling, do not damage electrical wiring or other hidden utilities.

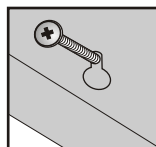
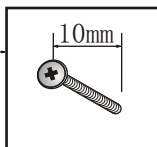
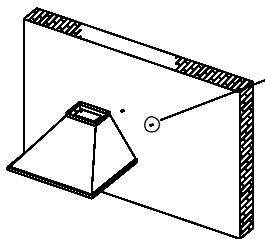

6

Hang the hood and let its 4 installation holes aim at 4 screws, adjust it to setting position.

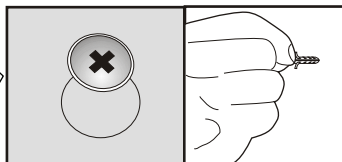
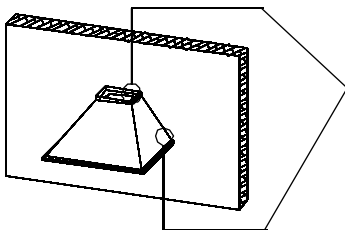

7

Screw down the four screws. first screw down the upper two screws, then screw down the other two screws.



Information

Please make sure the outside dimension of the screws is 10mm.

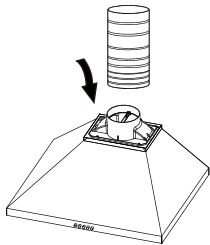

8

Connect the hose with the air duct.

The cooker hood is fully convertible for different venting direction.

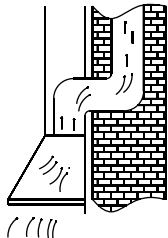

9

Vertical is the most common. If your kitchen has an attic space above, the ducting may be run up through the cupboard and attic to a roof cap.

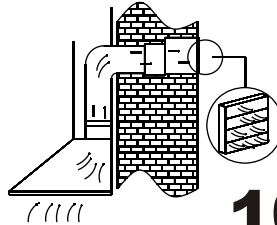

10

If your kitchen has a socket above the cupboards, you may run the duct up into the socket and then discharge horizontally through the outside wall to a wall cap.



Information

The air must not be discharged into a fuel that is used for exhausting fumes from appliances burning gas or other fuels.

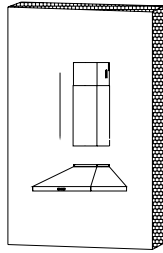

11

Put the outer chimney on the windshield, fix it on the air chamber with Phillips head screwdriver.

i

Information

Installation work and electrical wiring must be done by qualified person(s) in accordance with all applicable codes and standards, including fire-rated construction.

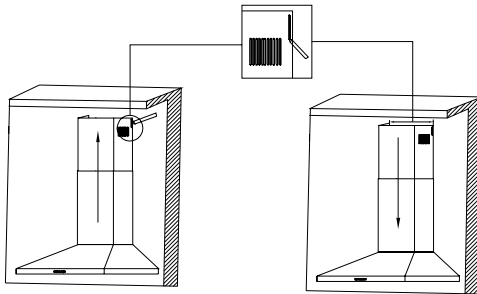

12

According to the dimension of the chimney fixed bolster, make sure the position of the two chimneys.

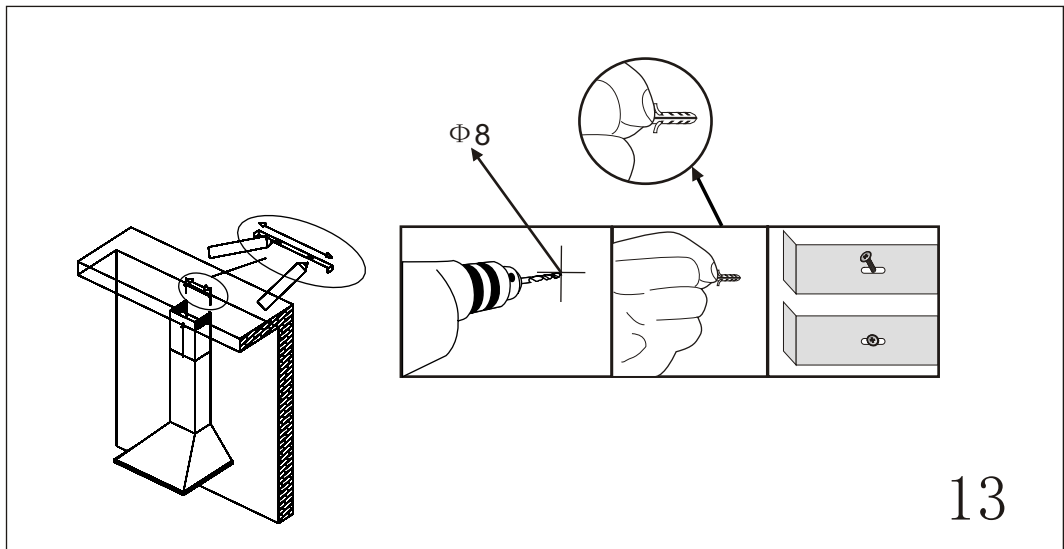

13

Install the chimney fixed bolster on the corresponding position on the wall.



Information

To install this hood you will require two assistants



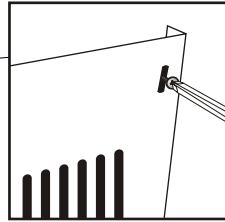
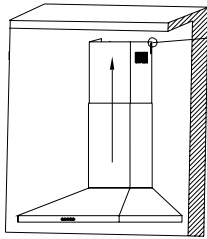

14

Use the Screw
ST4*10 to connect
the chimney fixed
bolster and the
upper chimney

Controls



15

Press the switch of light to be on, the left and right bulbs light on. Otherwise the bulbs don't work. When pressing the push button **1** on, the motor runs at low speed. When pressing the push button **2** on, the motor runs at middle speed. When pressing the push button **3** on, the motor runs at high speed. When pressing the push button **0** on, the motor stops running.



Information

Do not touch the light bulb within half an hour after appliance use.

The lamp shall not be covered with thermal insulation or other material



Replacement and maintenance

If the supply cord is damaged, it must be replaced by the manufacturer or its service agent or a similarly qualified person in order to avoid a hazard.

Replacing lamp

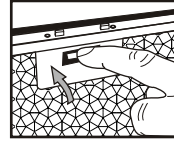
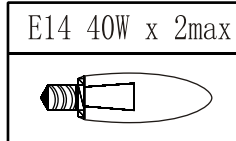
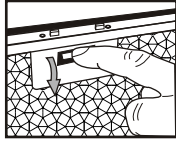

16

1. Take the fixed lamp rim off by unscrewing it in an anti-clockwise direction.
2. Draw the old lamp out of the lamp holder, insert the new lamp in the lamp holder.
3. Screw the fixed lamp rim tightly in a clockwise direction.

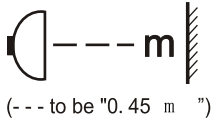

Required min. distance to surfaces (such as lids, oven cloth or the like) in order to prevent hot parts and fire hazards.

17



Only self shielded lamps can be used in order to prevent undue hot parts, fire hazards and exposure to UV radiation.



Information

The power of bulb must not be more than 40W.

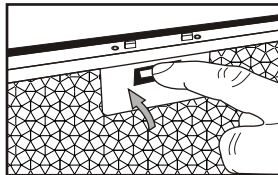
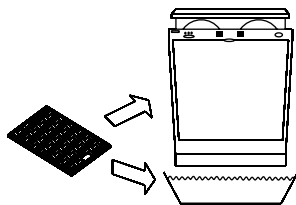
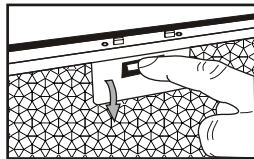

- It is recommendable to clean the metallic filter every three months by carrying out the following instructions:
 - Remove the metallic filter from the cooker hood and wash it in a solution of water and neutral liquid detergent, leaving to soak
 - Rinse thoroughly with warm water and leave to dry.
 - The metallic filter may also be washed in the dishwasher.The metallic filter may alter in colour after several washes. This is not cause for customer complaint nor replacement of metallic filter.



Information

There is a fire risk if cleaning is not carried out in accordance with the instructions.

Correct Disposal of this product



This marking indicates that this product should not be disposed with other household wastes throughout the EU. To prevent possible harm to the environment or human health from uncontrolled waste disposal, recycle it responsibly to promote the sustainable reuse of material resources. To return your used device, please use the return and collection systems or contact the retailer where the product was purchased. They can take this product for environmental safe recycling.

The manufacturer shall decline all responsibility if the foregoing recommendations and instruction regarding installation, maintenance and use are not observed and respected when using the cooker hood.



Worldwide Appliances Pty Limited

A.B.N. 45868077422

Office:

48-50 Moore Street, Leichhardt N.S.W 2040

Post:

Locked Bag 3000, Annandale, N.S.W 2038

P: 1300 694 583

WARRANTY REGISTRATION

Your ongoing satisfaction with your artusi product is important to us. We ask that you complete the enclosed Warranty Registration Card and return it to us so that we have a record of the artusi product purchased by you.

PRIVACY

Worldwide Appliances respects your privacy and is committed to handling your personal information in accordance with the National Privacy Principles and the Privacy Act 1988 (Cth). A copy of the Worldwide Appliances Privacy Policy is available at www.artusi.com.au. Worldwide Appliances will not disclose any personal information set out in the Warranty Registration Card ("Personal Information") without your consent unless required by:

1. law;
2. any Worldwide Appliances related company;
3. any service provider which provide services to artusi or assist artusi in providing services (including repair and warranty services) to customers. Our purpose in collecting the Personal Information is to keep a record of the artusi product purchased by you, in order to provide a better warranty service to you in the unlikely event that there is a problem with your artusi product. Worldwide Appliances may contact you at any one or more of the address, email address or telephone

numbers set out in the Warranty Registration Card. Please contact artusi on 1300 694 583 should you not wish to be contacted by Worldwide Appliances.

WARRANTY

1. Warranty

Worldwide Appliances warrants that each artusi product will remain, for a period of either 12 months or 24 months of warranty. All Warranties are valid from the original date of purchase, And warranty claims must be accompanied by the proof of purchase.

24 months warranty products:

All Built-in Appliances – Limited to Ovens, Gas, Induction and Electric Cooktops, and All Rangehoods

Freestanding Cookers - Gas and Electric Models (900mm Width)

Dishwashers - Freestanding, Fully Integrated, Semi Integrated and built-in

12 months warranty products:

Freestanding Cookers - Gas and Electric Models in 50cm, 54cm and 60cm Widths

Portable Appliances* – Benchtop Models and Portable Gas Models

2. What is not Covered by the Warranty.

The Warranty does not apply if an artusi product is defective by a factor other than a defect arising in the manufacture of the artusi product, including but not limited to:

- (a) damage through misuse (including failure to maintain, service or use with proper care), neglect, accident or ordinary wear and tear (including deterioration of parts and accessories and glass breakage);
- (b) use for purpose for which the artusi product was not sold or designed;
- (c) use or installation which is not in accordance with any specified instructions for use or installation;
- (d) use or operation after a defect has occurred or been discovered;

(e) damage through freight, transportation or handling in transit (other than when Worldwide Appliances is responsible);

(f) damage through exposure to chemicals, dusts, residues, excessive voltage, heat, atmospheric conditions or other forces or environmental factors outside the control of Worldwide Appliances;

(g) repair, modification or tampering by the purchaser or any person other than Worldwide Appliances, an employee of Worldwide Appliances or an authorised artusi service contractor*;

(h) use of parts, components or accessories which have not been supplied or specifically approved by artusi.

(i) damage to surface coatings caused by cleaning or maintenance using products not recommended in the artusi product handbook provided to the purchaser upon purchase of the artusi product;

(j) damage to the base of an electric oven due to items having been placed on the base of the oven cavity or covering the base, such as aluminium foil (this impedes the transfer of heat from the element to the oven cavity and can result in irreparable damage); or

(k) damages, dents or other cosmetic imperfections not affecting the performance of the artusi in respect of an artusi product purchased as a "factory second" or from display

The Warranty does not extend to light globes used in artusi products.

3. Domestic Use

Each artusi product is made for domestic use. This Warranty may not extend to artusi products used for commercial purposes.

Continued over...

4. Time for Claim under the Warranty

You must make any claim under this Warranty within twenty eight (28) days after the occurrence of an event which gives rise to a claim pursuant to the Warranty, by booking a service call on the telephone number below.

5. Proof of Purchase

Customers must retain proof of purchase in order to be eligible to make a warranty claim in respect of an artusi product.

6. Claiming under the Warranty

Customers will bear the cost of claiming under this Warranty unless Worldwide Appliances determines the expenses are reasonable, in which case the customer must claim those expenses by providing written evidence of each expense to Worldwide Appliances at the address on the Warranty Registration Card.

7. Statutory Rights

(a) These terms and conditions do not affect your statutory rights.

(b) The limitations on the Warranty set out in this document do not exclude or limit the application of the consumer guarantees set out in the Act or any other equivalent or corresponding legislation in the relevant jurisdiction where to do so would:

(i) contravene the law of the relevant jurisdiction; or

(ii) cause any part of the Warranty to be void.

(c) Worldwide Appliances excludes indirect or consequential loss of any kind (including, without limitation, loss of use of the artusi product) and (other than expressly provided for in these terms and conditions) subject to all terms, conditions and warranties implied by custom, the general law, the Act or other statute.

(d) The liability of Worldwide Appliances to you

for a breach of any express or non-excludable implied term, condition or warranty is limited at the option of Worldwide Appliances to:

(i) replacing or repairing the defective part of the artusi product;

(ii) paying the cost of replacing or repairing the defective part of the artusi product;

(iii) replacing the artusi product; or

(iv) paying the cost of replacing the artusi product.

(e) Our goods come with guarantees that cannot be excluded under the Australian Consumer Law. You are entitled to a replacement or refund for a major failure and for compensation for any other reasonably foreseeable loss or damage. You are also entitled to have the goods repaired or replaced if the goods fail to be of acceptable quality and the failure does not amount to a major failure.

8. Defects

Any part of an artusi product deemed to be defective and replaced by Worldwide Appliances is the property of Worldwide Appliances. Worldwide Appliances reserves the right to inspect and test artusi products in order to determine the extent of any defect and the validity of a claim under the Warranty.

*To locate your closest artusi authorised service agent please contact us on 1300 652 100 or visit www.artusi.com.au

ALL SERVICE CALLS MUST BE BOOKED THROUGH AN AUTHORISED DEALER OR WARRANTY DEPARTMENT ON 1300 652 100 OR stokesaps.com.au/artusi-service

01032014



WARRANTY REGISTRATION CARD
01052013

Please complete and send to ARTUSI at: REPLY PAID 83617
LEICHHARDT NSW 2040

Last Name:		First Name:	
Address:			
State:	Postcode:	Email:	
Home Phone:		Mobile:	
Purchase Date: / /		(Please attach proof of purchase to validate warranty)	

MODEL NUMBER	SERIAL NUMBER <small>(if you cannot locate the serial number please call ARTUSI on 1300 694 583)</small>
1	
2	
3	
4	

Warranty Card tear off

01032014