

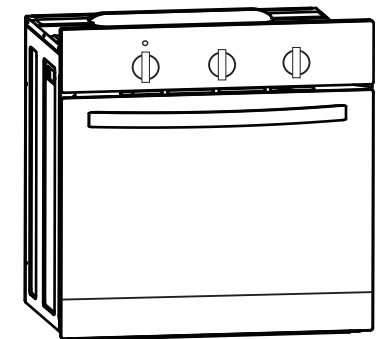

AO601X AO601B
AO601W AO601X/1
CAO6X CAO600X
CAO600B CAO600W



INSTRUCTION MANUAL

BUILT-IN ELECTRIC OVEN

Do not use the oven until you have read this instruction manual

DEAR CUSTOMER

Congratulations on your purchase. Our products are exceptionally easy to use and extremely efficient. After reading the instruction manual, operating the oven will be easy.

Before being packaged and leaving the manufacturer, the cooker was thoroughly checked with regard to safety and functionality.

These instructions have been compiled in order to help you learn how to handle the appliance. So please read them carefully before you use the appliance for the first time in order to avoid possible accidents.

Please keep the instruction manual and store it in a safe place so that it can be consulted at any time.

It is necessary to follow the instructions in the manual carefully in order to avoid possible accidents.

TABLE OF CONTENTS

Safety instructions.....	4
How to save energy.....	5
Disposal of the appliance.....	5
Unpacking.....	5
Description of the appliance.....	6
Installation.....	8
Operation.....	10
Prior first use.....	10
Electronic programmer.....	10
Oven.....	15
Cleaning and maintenance.....	17
Operation in case of emergency.....	19
Baking in the oven.....	20
Technical information.....	24

SAFETY INSTRUCTIONS

- The appliance becomes very hot during operation. Take care not to touch the heating elements inside the oven.
- **WARNING:** Accessible parts may become hot during use. To avoid burns young children should be kept away.
- Mains lead of adjacent appliances may be damaged by hobs or stuck between the oven doors, and produce short circuit, therefore keep them at safe distance from the appliance.
- Never put pans weighing over 15kg on the opened door of the oven.
- Do not use the oven in the event of a technical fault, once a technical fault caused, disconnect the power and report the fault to the service center to be repaired.
- Never clean the oven with the high-pressure steam cleaning device, as it may provoke short circuit.
- Do not use harsh abrasive cleaners or sharp metal scrapers to clean the door glass as they can scratch the surface, which could then result in the glass shattering.
- The rules and provisions contained in this instruction manual should be strictly observed. Do not allow anybody who is not familiar with the contents of this instruction manual to operate the oven.
- During use the appliance becomes hot, care should be taken to avoid touching heating elements inside the oven.
- If the supply cord is damaged, it must be replaced by the manufacturer, its service agent or similarly qualified persons in order to avoid a hazard.
- The appliance is not intended for use by persons (including children) with reduced physical, sensory or mental capabilities, or lack of experience and knowledge, unless they have been given supervision or instruction concerning use of the appliance by a person responsible for their safety.
- Children should be supervised to ensure that they do not play with the appliance.
- **WARNING:** Ensure that the appliance is switched off before replacing the lamp to avoid the possibility of electric shock.
- **WARNING:** Accessible parts may become hot during use. To avoid burns young children should be kept away.
- **WARNING:** The appliance and its accessible parts become hot during use.
- Care should be taken to avoid touching heating elements.
- Children less than 8 years of age shall be kept away unless continuously supervised.
- This appliance can be used by children aged from 8 years and above and persons with reduced physical, sensory or mental capabilities or lack of experience and knowledge if they have been given supervision or instruction concerning use of the appliance in a safe way and understand the hazards involved. Cleaning and user maintenance shall not be made by children without supervision.
- **WARNING:** Accessible parts may become hot during use.
- Young children should be kept away
- During use the appliance becomes hot. Care should be taken to avoid touching heating elements inside the oven

HOW TO SAVE ENERGY



Using energy in a responsible way not only saves money but also helps the environment.

So let's save energy! And this is how you can do it:

- Make use of residual heat from the oven. If the cooking time is greater than 40 minutes, switch off the oven 10 minutes before the end time. Important when using the timer, set appropriately shorter cooking times according to the dish being prepared.
- Make sure the oven door is properly closed. Heat can leak through spillages on the door seals. Clean up any spillages immediately.
- Do not install the oven in the direct vicinity of refrigerators/freezers. Otherwise energy consumption increases unnecessarily.

UNPACKING

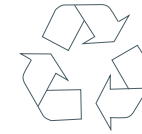

During transportation, protective packaging was used to protect the appliance against any damage.

After unpacking, please dispose of all elements of packaging in a way that will not cause damage to the environment. All materials used for packaging the appliance are environmentally friendly; they are 100% recyclable and are marked with the appropriate symbol.

Caution!

During unpacking, the packaging materials (polythene bags, polystyrene pieces, etc.) should be kept out of reach of children.

DISPOSAL OF THE APPLIANCE



Old appliances should not simply be disposed of with normal household waste, but should be delivered to a collection and recycling centre for electric and electronic equipment.

A symbol shown on the product, the instruction manual or the packaging shows that it is suitable for recycling.

Materials used inside the appliance are recyclable and are labeled with information concerning this. By recycling materials or other parts from used devices you are making a significant contribution to the protection of our environment.

Information on appropriate disposal centers for used devices can be provided by your local authority.

DESCRIPTION OF THE APPLIANCE

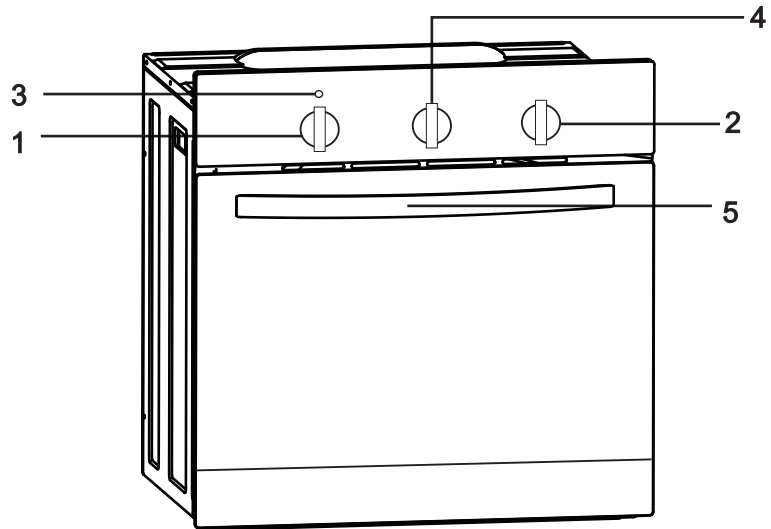

- 1 Temperature control knob
- 2 Oven function selection knob
- 3 Oven temperature indicator
- 4 Mechanical timer
- 5 Oven door handle
- 6 Electronic programmer

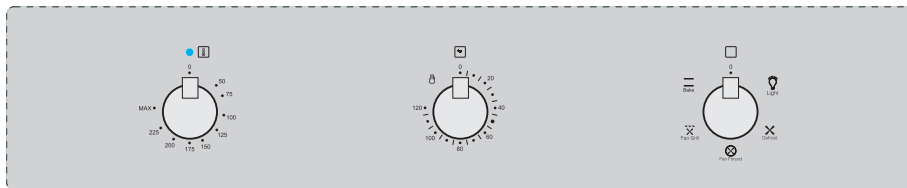

CAO6X

DESCRIPTION OF THE APPLIANCE

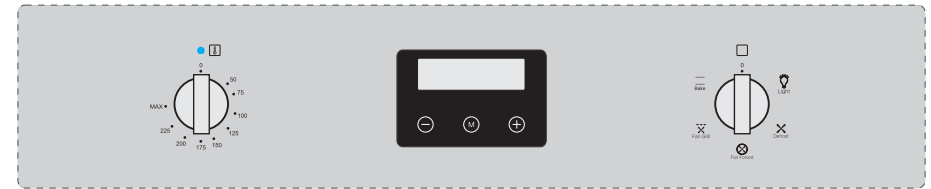

AO601X

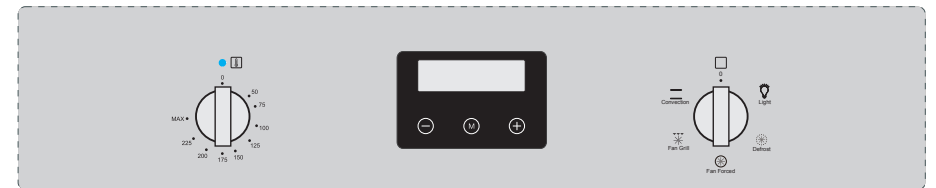

AO601X/1

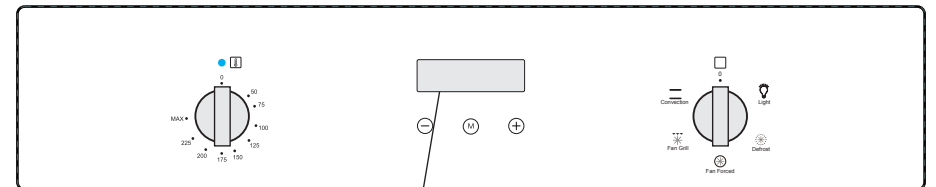

6

AO601W/AO601B

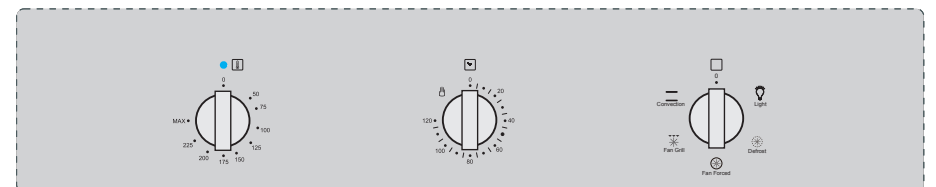

CAO600X/CAO600B/CAO600W

INSTALLATION

▶ Installing the oven

- The kitchen should be dry and have effective ventilation according to the existing technical provisions.
- Main lead behind the oven must be placed in such manner to avoid touching the back panel of the oven because of the heat it develops during operation.
- Remove any packaging materials (foils, artificial foam, nails, etc.) from the reach of children, because they represent potential danger. Children may swallow small parts, or suffocate with foils.
- This is a built-in oven, which means that its back wall and one side wall can be placed next to a high piece of furniture or a wall. Coating or veneer used on fitted furniture must be applied with a heat resistant adhesive (100°C). This prevents surface deformation or detachment of the coating. If you are unsure of your furniture's heat resistance, you should leave approximately 2cm of free space around the oven. The wall behind the oven should be resistant to high temperatures. During operation, its back side can warm up to around 50°C above the ambient temperature.
- Make an opening with the dimensions given in the diagram for the oven to be fitted.
- The appliance must be earthed.
- Insert the oven completely into the opening without allowing the four screws in the places shown in the diagram to fall out.

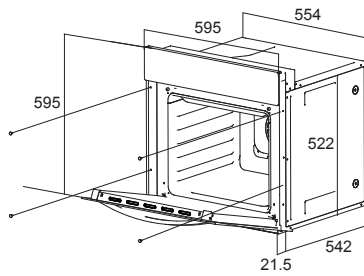

CAO6X, AO601X

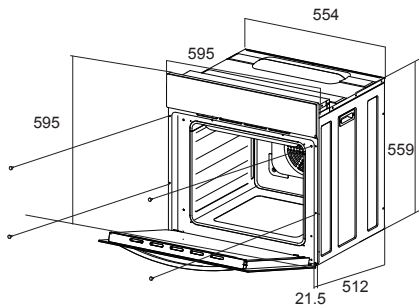

AO601X/1, AO601W, AO601B
CAO600X, CAO600W, CAO600B

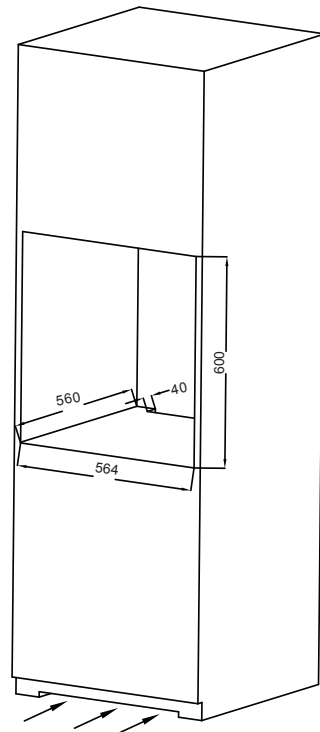

INSTALLATION

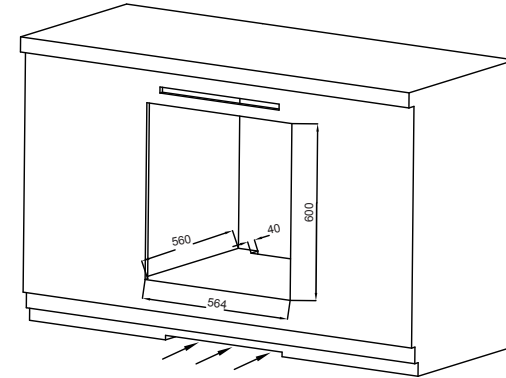

▶ Electrical connection

Warning!

All electrical work must be carried out by a suitably qualified and authorized electrician. No alterations or willful changes in the electricity supply should be carried out.

- Before attempting the connection, check whether the voltage indicated on the rating plate corresponds to the actual mains voltage.
- Mains lead should be minimum 1.5m long.
- Earthing wire should be installed in such manner to be the last one pulled out in case the safety relief device of the mains lead should fail.
- Mains lead behind the oven must be placed in such manner to avoid touching the back panel of the oven because of the heat it develops during operation.
- The cable of correct size rating must be used cable type H05VV-F 3 × 1.5m². the grounding wire shall be longer than the other wires.
- The means for disconnection from the supply mains having a contact separation in all poles that provide full disconnection under over voltage fixed wiring in accordance with the

Connection (by authorised electrician)

- Using the screwdriver open the connector cover at the rear of the appliance. Release two locks located at either side of the connector bottom.
- Mains lead must be led through the relief safety device, protecting the mains lead cable from disconnection.
- Tighten the relief device securely and close the connector cover.

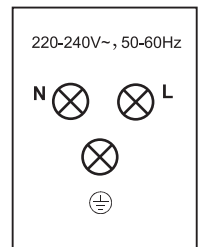
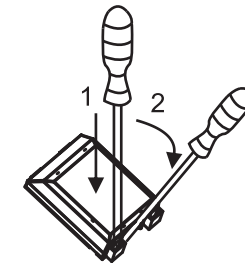

Colour code

L = exterior live wires, usually coloured black, brown.

N=neutral

The colour is usually blue.

Beware of the correct N-connection!



E = earthing wire, the colour is green/yellow.

OPERATION

▷ Prior first use

- Remove packaging, clean the interior of the oven.
- Take out and wash the oven fittings with warm water and a little washing-up liquid.
- Switch on the ventilation in the room or open a window.
- Heat the oven (to a temperature of 250°C, for approx. 30 min.), remove any stains and wash carefully.

Caution!

When heat the oven for the first time, it is normal phenomenon to give off smoke and peculiar smell. This will disappear about 30 min later.

▷ Electronic programmer

(Only for AO601X, AO601X/1, AO601W, AO601B)

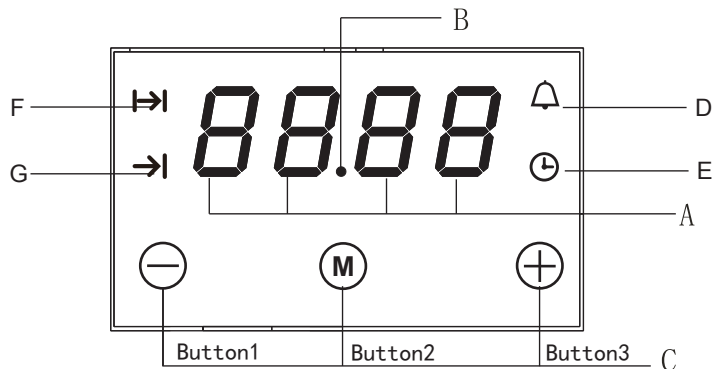

A - Display field

B - Seconds Icon

C - Buttons

D - Timer

E - Current time

F - Cooking time

G - End of cooking time

M - Function

⊖ - To decrease the numbers on the digital display

⊕ - To increase the numbers on the digital display

OPERATION

Setting the time

1. At power on, displayed "12.00", and ⊖ flashes.

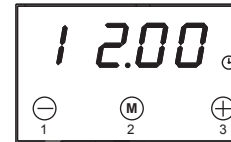

2. The current time can be set with button 1 and 3, 5 seconds after the time has been set, the new data will be saved.

3. 5 seconds after the time is set, or directly press the button 2, the signal function Δ is on, your setting is saved.

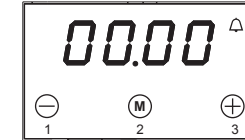

4. When the set time is up the alarm signal will be activated and the signal function Δ starts flashing again.

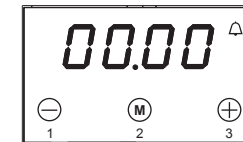

Timer

The timer can be activated at any time and any function. The timer can be set from 1 minute to 23 hours and 59 minutes.

To set the timer you should:

1. Press button 2, flashing Δ. Enter the timer setting.



2. Set the timer using buttons 1 and 3.



5. Press any button, the signal function Δ and alarm signal will go off. Or the alarm signal will be turned off automatically after 2 minutes.

OPERATION

Caution!

Besides timer alarm, any other alarms can be turned off by pressing any button. If the alarm signal is not turned off manually, it will be turned off automatically after 2 minutes.

Semi-automatic operation

If the oven is to be switched off at a given time, or after defined period, you should:

1. Set the oven function knob and the temperature regulator knob to the setting at which you want the oven to operate.
2. Press the function button, the oven will begin to work and the function signal $\rightarrow|$ flashing.
3. Press button 1 or 3 to adjust the cooking time, within a range from 1 minute to 10 hours.
4. Or press button "MODE" twice. then the display will show flashing $\rightarrow|$. Set the end time by buttons 1 and 3.
5. The set time is introduced to the memory after 5 seconds.
6. When the set time passed, the oven is switched off automatically, the alarm is activated.
7. Press any button, the alarm signal and the $\rightarrow|$ icon will go off, Or the alarm signal will be turned off automatically after 2 minutes.

Caution!

- The cooking time and end of cooking time range:
Cooking time range: $0 < t \leq 10$ hours
End of cooking time range: current time $<$ end of cooking time \leq current time + 10 hours
End of cooking time = current time + cooking time
- When using the semi-automatic operation, set either the cooking time or the end of cooking time.
- If you set the cooking time to 0 or set the end of cooking time to the current time, the auto function will be off.
- After the auto function be off, the cooking time to 0, end of cooking time and current time remains the same.

For example:

The current time is 2:00, want to oven work of 3 hours, end of cooking time is set to be 5:00 ($2:00 + 3:00 = 5:00$).

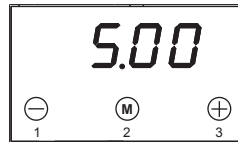

There are two methods to achieve this setting:

First method:

1. Set the cooking time using buttons 1 and 3.

OPERATION

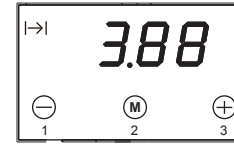

2. End of cooking time automatically change to 5:00.

Second method:

1. Set the end of cooking time using buttons 1 and 3.

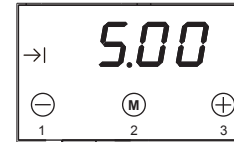

2. Cooking time automatically change to 3:00. 5 seconds after the setting, the auto function is on. 3 hours later, the current time shows "5.00" The alarm signal is activated.

Automatic operation

If the oven is to be switched on for a specified period of time and switched off at a fixed hour then you should set the cooking time and the end of cooking time:

1. Set the oven function knob and the temperature regulator knob to the setting at which you want the oven to operate.
2. Press button 2, the oven will begin to work and the function signal $\rightarrow|$ flashing.
3. Press button 1 or 3 to adjust the cook time, within a range from 1 minute to 10 hours.
4. And press button 2. then the display will show flashing $\rightarrow|$. Set the cooking time using buttons 1 and 3.
5. The set time is introduced to the memory after 5 seconds, the $\rightarrow|$ and $\rightarrow|$ always on.
6. When the set time passed, the oven is switched off automatically, the alarm is activated. and the $\rightarrow|$ will go off.
7. Press any button, the alarm signal and the $\rightarrow|$ icon will go off, Or the alarm signal will be turned off automatically after 2 minutes.

OPERATION

Caution!

- Work time = end of cooking time - cooking time

For example:

If the current time is 2:00; cooking time set to be 3 hours ; end of cooking time set to be 10:00, the work time will be 7:00 (7:00=10:00-3:00).

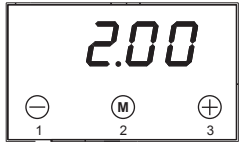

1. Set the cooking time to be "3.00" with buttons 1 and 3.



2. Set the end of cooking time to be "10.00" with buttons 1 and 3.

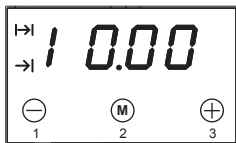

3. 5 seconds after setting, the auto function is on.

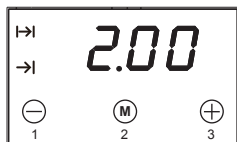

4. When it up to 7:00 , the oven will begin to work.



5. When it up to 10:00 , the alarm signal is activated. The oven is switched off automatically.



- End of cooking time > current time + cooking time <= 10hours
- At least more than one minute cooking time, cooking time and end of cooking time must be set.
- If the cooking time set to be 0 or the end of cooking time set to be the current time, the auto function will be off.
- After the auto function be off, the cooking time to 0, end of cooking time and current time remains the same.

OPERATION

Mechanical timer

(Only for CAO6X, CAO600X, CAO600B, CAO600W)

When using the oven, you must set food cooking time.

1. Turn mechanical timer to the time

position you want.

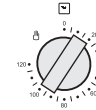

2. Turn function knob to the function

position you want.

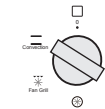

3. Turn temperature knob to the

temperature position you want.

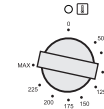

4. After above operation, oven knob runs normally.
5. When oven works till pre-set time, timer will have sound which means the cooking is finished.

If you don't want the oven work controlled by the mechanical timer , you can turn the mechanical timer to

the position

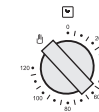

Caution!

Don't turn mechanical timer in a clockwise way front 120 to " " .

Oven

Oven is controlled by the function knob and the temperature control knob.

Caution!

When selecting any heating function (switching a heater on etc.) the oven will be switched on only after the temperature has been set by the temperature control knob.

Possible settings of the oven function knob



Separate oven lighting

Light

By setting the knob to this position the lighting inside the oven is switched on



Convection

Bottom and top element on

Setting the knob to this position allows the oven to be heated conventionally.



Fan(Defrost)

Defrost

At this function, the fan only works. You can cool the dish or the oven chamber or defrost food.



Fan Grill

Fan grill

Air movement inside the oven softens the intense heat of the grill, optimal for the cooking of thick cuts of meat, for example.



Fan Forced

Fan forced

A heating element around the fan enables the most uniform heating possible. This mode minimises preheating time, and is also the best for cooking several different types of food at once.

OPERATION

Caution!

When the functions with fan have been selected but the temperature knob is set to zero only the fan will be on.

With this function you can cool the dish or the oven chamber.

Oven guide levels

Baking pans and accessories (oven grid, baking tray, etc) may be inserted into the oven in 5 guiding levels.

Appropriate levels are indicated in the tables that follow.

Always count levels from the bottom upwards!

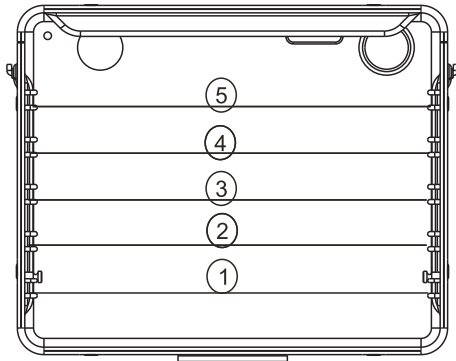

CLEANING AND MAINTENANCE

Caution!

By ensuring proper cleaning and maintenance of your oven you can have a significant influence on the continuing fault-free operation of your appliance.

Do not use cleaning products containing abrasive materials for the cleaning and maintenance of the glass front panel.

Before you start cleaning, the oven must be switched off and you should ensure that all knobs are set to the "0" position. Do not start cleaning until the oven has completely cooled.

▷ Oven cleaning

- The oven should be cleaned after every time use.
- Cool the oven completely before cleaning.
- Never clean the appliance with pressurized hot steam cleaned.
- The oven chamber should only be washed with warm water and a small amount of washing-up liquid.
- **Steam cleaning**
 - pour 250m l of water (1 glass) into a bowl placed in the oven on the first level from the bottom.
 - Close the oven door.
 - Set the temperature knob to 100°C, and the function knob to the bottom heater position.
 - Heat the oven chamber for approximately 30 minutes.
 - Open the oven door, wipe the chamber inside with a cloth or sponge and wash using warm water with washing-up liquid.
- After cleaning the oven chamber wipe it dry.

CLEANING AND MAINTENANCE

▷ Replacement of the oven light Bulb

Before any maintenance is started involving electrical parts, the appliance must be disconnected from the power supply.

If the oven has been in use, let the oven cavity and the heating elements cool down before attempting any **maintenance**.

Changing the bulb

- Unscrew the protective cover. We recommend that you wash and dry the glass cover at this point.
- Carefully remove the old bulb and insert the new bulb suitable for high temperatures (300°C) having the following specifications: 220-240V, 50-60Hz, 25W, G9 fitting.
- Refit the protective cover.

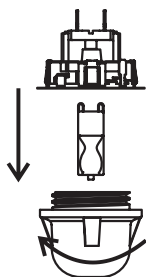

IMPORTANT

Never use screwdrivers or other utensils to remove the light cover. This could damage the enamel of the oven or the lampholder. Remove only by hand.

IMPORTANT

Never replace the bulb with bare hands as contamination from your fingers can cause premature failure. Always use a clean cloth or gloves.

Please note:

The bulb replacement is not covered by your guarantee

▷ Door removal

In order to obtain easier access to the oven chamber for cleaning, it is possible to remove the door.

To do this, tilt the safety catch part of the hinge upwards. Close the door lightly, lift and pull it out towards you. In order to fit the door back on to the cooker, do the inverse. When fitting, ensure that the notch of the hinge is correctly placed on the protrusion of the hinge holder. After the door is fitted to the oven, the safety catch should be carefully lowered down again. If the safety catch is not set it may cause damage to the hinge when closing the door.

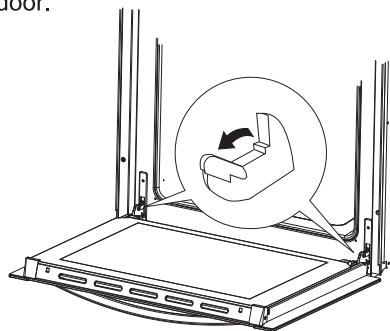

Tilting the hinge safety catches

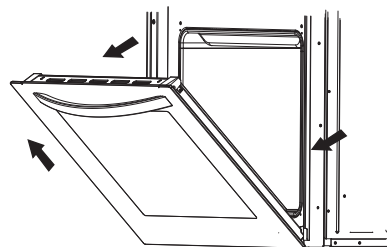

Door removal

CLEANING AND MAINTENANCE

▷ Removal of the internal glass panel

Unscrew and unfasten the plastic latch that is in the corner at the top of the door. Next take out the glass from the second blocking mechanism and remove. After cleaning, insert and block the glass panel, and screw in the blocking mechanism.

(Only for CAO6X, AO601X)

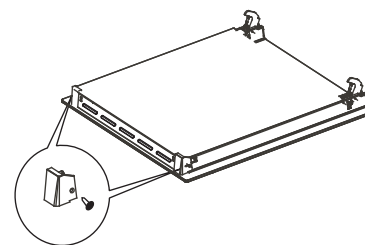

Removal of the internal glass panel

(Only for AO601W, AO601B, AO601X/1, CAO600W, CAO600B, CAO601X)

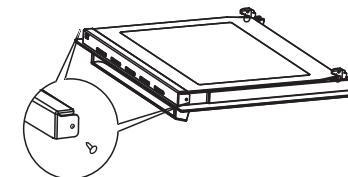

Removal of the internal glass panel

OPERATION IN CASE OF EMERGENCY

In the event of an emergency, you should:

- Switch off all working units of the oven
- Call the service centre
- Some minor faults can be fixed by referring to the instructions given in the table below. Before calling the customer support centre or the service centre check the following points that are presented in the table.

PROBLEM	REASON	ACTION
1. The appliance does not work.	Break in power supply.	Check the household fuse box; if there is a blown fuse replace it with a new one
2. The programmer display is flashing "12.00".	The appliance was disconnected from the mains or there was a temporary power cut.	Set the current time (see Use of the programmer)
3. The oven light does not work.	The bulb is loose or damaged.	Tighten up or replace the blown bulb (see Cleaning and Maintenance)

BAKING IN THE OVEN

▷ Baking pastry

Most appropriate position for baking is the application of both upper and lower heater, or the hot air.

Warning!

- The baking parameters given in Tables are approximate and can be corrected based on your own experience and cooking preferences;
- In case you may not find any particular type of cake in the tables, use the information available for the next most similar type of cake.

Baking with upper and lower heaters

- Use only a single guide level.
- This baking position is especially suitable for baking dry pastry, bread and teacakes. Use dark baking pans. Light pans reflect heat and pastry is not adequately browned.
- Always place baking pans on the grid rack. Remove the grid only of baking in the flat biscuit tray, supplied with the appliance.
- Preheating shortens the baking time. Do not put the cake in the oven until proper temperature is obtained.

Baking tips

Is pastry baked?

Pierce the cake with a wooden peg at the thickest part, if the dough does not stick to it, the cake is baked. You may switch off the oven and use the remaining heat.

Pastry has fallen

Check the recipe. Use less fluid next time. Follow the mixing times, especially when using powered kitchen mixers.

Pastry is too light below

Use dark baking pan next time, or place the pan one level lower, or switch on the lower heater a while before the completion.

Cheese cake is undercooked

Next time reduce the baking temperature and extend the baking time.

Warnings regarding the baking tables

- The tables indicate the temperature range. Always select lower temperature first. You may always increase the temperature in case pastry needs more baking.
- Baking times are indicative only. They may vary in dependence of individual characteristics.
- The asterix indicates that the oven requires preheating.

BAKING IN THE OVEN

Baking Table

Type of pastry	Guide level from down upwards)	Temp(°C) ⊛ Fan Forced	Baking time (in min.)
Sponge cake/marble cake	2	150-170	60-80
Victoria sponge	2	150-170	65-80
Base for a layer cake	2-3	150-170	20-30
Sponge layer cake			30-40
Fruit cake(crispy base)	2-3	160-180	60-70
Cheesecake(shortcrust)	2	140-150	60-90
Teacake	2	150-170	40-60
Bread(e.g.wholegrain bread)	2	150-170	50-60
Fruit cake(crispy base)	2	160-200	35-60
Fruit cake(with yeast)	2	160-170	30-50
Crumble cake		150-170	30-40
Sponge roll			10-15
Pizza(thin base)			10-15
Pizza(thick base)			30-50
Puff pastry	2	170-190	18-25
Meringues			80-90
Choux buns	2	170-190	35-45

BAKING IN THE OVEN

▷ Roasting

Best results are obtained with the engagement of both upper and lower. Best heating mode for each type of roasting pan is indicated by bold print in the Roasting Tables.

Tips regarding roasting pans

- Use light enamel pans, temperature resistant glass pans, clay dishes or wrought iron dishes.
- Stainless steel dishes are not recommendable because they excessively reflect heat.
- Cover your roast or wrap it in foil. It will preserve its juice and the oven will remain cleaner.
- If you leave the pan uncovered the roast will be cooked sooner. Roast large chunks of meat directly on the grid, with intercepting pan underneath.

Attention when roasting!

Roasting tables indicate suggested temperatures, guide level and roasting times. Roasting time largely depends upon the type of meat, its size and quality. So you may expect some variations

- Roasting of large chunks of meat may produce excessive steaming and dew formation at the oven door. This is quite normal, and does not affect the operation of the oven. However, after the completion of roasting wipe the oven door and the glass thoroughly.
- Roasting of red meat, poultry and fish is rational if the roast exceeds one kilogram in size.
- Add as much liquid as necessary to prevent burning of juice, dripping from neat. Roast must be surveyed at all times. And liquid added if necessary.
- At approximately the middle of the indicated time turn the roast round, especially if you use the deep roast dish.
- When roasting on the grill grid, place the grid in the deep roasting pan and insert both into the sliding guide. The bottom pan will intercept dripping fat.
- Never leave roast to cool in the oven, as it might produce dew and corrosion of the oven.

BAKING IN THE OVEN

Roasting table

Type of meat	Guide level (from bottom up)	temp (°C)  Fan Forced	Roasting time (in min.)
Beef			
			per 1 cm
Roast beef or fille rare	3	250	12 -15
oven warmed up juicy("medium")	3	250	15 -25
oven warmed up "well done"	3	210-230	25-30
oven warmed up Roast joint	2	200-220	120-140
Pork			
Roast joint	2	200-210	90-140
Ham	2	200-210	60 -90
Fillet	3	210-230	25 -30
VEAL	2	200-210	90 -120
LAMB	2	200-220	100-120
VENISON	2	200-220	100-120
POULTRY			
Chicken	2	220-250	50 -80
Goose(approx.2kg)	2	190-200	150-180
FISH	2	210-220	50 - 80

TECHNICAL INFORMATION

Model	AO601B, AO601W, AO601X/1, AO601X CAO600X, CAO600B, CAO600W, CAO6X
Voltage ratly	220-240V 50-60Hz
Total power	2000W
Upper heater	850W
Gill heater	1100W
Lower heater	1150W
Circular heater	2000W
fan	●

Warranty Card

artusi.com.au



Worldwide Appliances Pty Limited

A.B.N. 45868077422

Distributed by Eurolinx Pty Ltd

Office:

48-50 Moore Street, Leichhardt N.S.W 2040

Post:

Locked Bag 3000, Annandale, N.S.W 2038

P: 1300 694 583

WARRANTY REGISTRATION

Your ongoing satisfaction with your artusi product is important to us. We ask that you complete the enclosed Warranty Registration Card and return it to us so that we have a record of the artusi product purchased by you.

PRIVACY

Worldwide Appliances respects your privacy and is committed to handling your personal information in accordance with the National Privacy Principles and the Privacy Act 1988 (Cth). A copy of the Worldwide Appliances Privacy Policy is available at www.artusi.com.au. Worldwide Appliances will not disclose any personal information set out in the Warranty Registration Card ("Personal Information") without your consent unless required by:

1. law;
2. any Worldwide Appliances related company;
3. any service provider which provide services to artusi or assist artusi in providing services (including repair and warranty services) to customers. Our purpose in collecting the Personal Information is

to keep a record of the artusi product purchased by you, in order to provide a better warranty service to you in the unlikely event that there is a problem with your artusi product. Worldwide Appliances may contact you at any one or more of the address, email address or telephone numbers set out in the Warranty Registration Card. Please contact artusi on 1300 694 583 should you not wish to be contacted by Worldwide Appliances.

WARRANTY

1. Warranty

Worldwide Appliances warrants that each artusi product will remain, for a period of either 12 months or 24 months of warranty. All Warranties are valid from the original date of purchase, And warranty claims must be accompanied by the proof of purchase.

24 months warranty products:

All Built-in Appliances – Limited to Ovens, Gas, Induction and Electric Cooktops, and All Rangehoods. Freestanding Cookers - Gas and Electric Models (900mm Width).

Dishwashers - Freestanding, Fully Integrated, Semi Integrated and built-in. All Wine coolers. All Dryers. Freestanding Cookers - Gas and Electric Models in 50cm, 54cm and 60cm Widths

Portable Appliances* – Benchtop Models and Portable Gas Models

2. What is not Covered by the Warranty.

The Warranty does not apply if an artusi product is defective by a factor other than a defect arising in the manufacture of the artusi product, including but not limited to:

- (a) damage through misuse (including failure to maintain, service or use with proper care), neglect, accident or ordinary wear and tear (including deterioration of parts and accessories and glass breakage);
- (b) use for purpose for which the artusi product was not sold or designed;
- (c) use or installation which is not in accordance with any specified instructions for use or installation;
- (d) use or operation after a defect has occurred or been discovered;
- (e) damage through freight, transportation or handling in transit (other than when Worldwide Appliances is responsible);
- (f) damage through exposure to chemicals, dusts, residues, excessive voltage, heat, atmospheric conditions or other forces or environmental factors outside the control of Worldwide Appliances;
- (g) repair, modification or tampering by the purchaser or any person other than Worldwide Appliances, an employee of Worldwide Appliances or an authorised artusi service contractor*;
- (h) use of parts, components or accessories which have not been supplied or specifically approved by artusi.

(i) damage to surface coatings caused by cleaning or maintenance using products not recommended in the artusi product handbook provided to the purchaser upon purchase of the artusi product;

(j) damage to the base of an electric oven due to items having been placed on the base of the oven cavity or covering the base, such as aluminium foil (this impedes the transfer of heat from the element to the oven cavity and can result in irreparable damage); or

(k) damages, dents or other cosmetic imperfections not affecting the performance of the artusi in respect of an artusi product purchased as a "factory second" or from display

The Warranty does not extend to light globes used in artusi products.

3. Domestic Use

Each artusi product is made for domestic use. This Warranty may not extend to artusi products used for commercial purposes.

Continued over...

Warranty Card continued

artusi.com.au

4. Time for Claim under the Warranty

You must make any claim under this Warranty within twenty eight (28) days after the occurrence of an event which gives rise to a claim pursuant to the Warranty, by booking a service call on the telephone number below.

5. Proof of Purchase

Customers must retain proof of purchase in order to be eligible to make a warranty claim in respect of an artusi product.

6. Claiming under the Warranty

Customers will bear the cost of claiming under this Warranty unless Worldwide Appliances determines the expenses are reasonable, in which case the customer must claim those expenses by providing written evidence of each expense to Worldwide Appliances at the address on the Warranty Registration Card.

7. Statutory Rights

(a) These terms and conditions do not affect your statutory rights.

(b) The limitations on the Warranty set out in this document do not exclude or limit the application of the consumer guarantees set out in the Act or any other equivalent or corresponding legislation in the relevant jurisdiction where to do so would:

(i) contravene the law of the relevant jurisdiction; or

(ii) cause any part of the Warranty to be void.

(c) Worldwide Appliances excludes indirect or consequential loss of any kind (including, without limitation, loss of use of the artusi product) and (other than expressly provided for in these terms and conditions) subject to all terms, conditions and warranties implied by custom, the general law, the Act or other statute.

(d) The liability of Worldwide Appliances to you

for a breach of any express or non-excludable implied term, condition or warranty is limited at the option of Worldwide Appliances to:

(i) replacing or repairing the defective part of the artusi product;

(ii) paying the cost of replacing or repairing the defective part of the artusi product;

(iii) replacing the artusi product; or

(iv) paying the cost of replacing the artusi product.

(e) Our goods come with guarantees that cannot be excluded under the Australian Consumer Law. You are entitled to a replacement or refund for a major failure and for compensation for any other reasonably foreseeable loss or damage. You are also entitled to have the goods repaired or replaced if the goods fail to be of acceptable quality and the failure does not amount to a major failure.

8. Defects

Any part of an artusi product deemed to be defective and replaced by Worldwide Appliances is the property of Worldwide Appliances. Worldwide Appliances reserves the right to inspect and test artusi products in order to determine the extent of any defect and the validity of a claim under the Warranty.

All warranty service calls must be booked via the customer care department. The team can be contacted on 1 300 85 64 11 option 1 or customercare@eurolinx.com.au

01082016



Warranty Card tear off

WARRANTY REGISTRATION CARD
01052016

Please complete and send to ARTUSI at: REPLY PAID 83617
LEICHHARDT NSW 2040

Last Name:		First Name:	
Address:			
State:	Postcode:	Email:	
Home Phone:		Mobile:	
Purchase Date: / /		(Please attach proof of purchase to validate warranty)	

MODEL NUMBER	SERIAL NUMBER (if you cannot locate the serial number please call ARTUSI on 1300 856 411)
1	
2	
3	
4	

01082016