

MANUAL

MEEPO VOYAGER

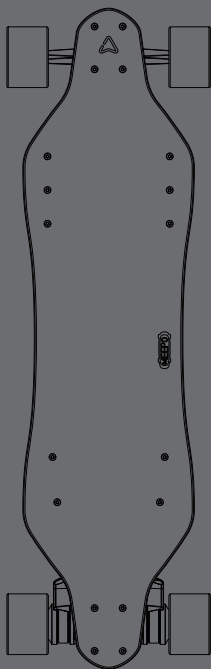

READ THE MANUAL CAREFULLY BEFORE YOU RIDE

⚠ YOUR BOARD MAY LOSE POWER AND BRAKES due to radio interference, a malfunctioning battery, downhill overcharging of the battery, or other factors. Only ride your Meepo board at speeds and on hills where you don't have to depend on breaks and acceleration.

⚠ BRAKING DOWNHILL WITH A FULL BATTERY WILL CAUSE THE BOARD TO SHUT DOWN since regenerative braking will overcharge the battery. To prevent this from happening, the remote will warn you by beeping, and disable your braking power. Safely come to a stop before this happens, and ride on flats or uphill to drain the battery before attempting to ride downhill again.

⚠ WARNING! IN EXPERT AND PRO MODE THE THROTTLE IS EXTREMELY SENSITIVE which means the board can accelerate aggressively causing you to fall off. Try to start by moving slowly in these modes to ensure safety.

⚠ HILLS AND HIGH SPEEDS CAN BE VERY DANGEROUS, crashes in these conditions may cause serious injury. Be extra careful when pushing the limits of the board, even if you're an experienced rider.

⚠ CARS AND OTHER VEHICLES CAN INJURE YOU so always be aware of your surroundings when riding in the presence of vehicles. Ride defensively and assume the vehicles can't see you. Remember that your board may lose power and brakes at any moment. Whenever you are riding, please be aware of the laws that govern the use of your board on public roads, bike paths, sidewalks, or other places that you may ride.

⚠ ALWAYS WEAR A HELMET. Other safety gear, like gloves, pads, and long sleeves, are highly recommended.

! WARNING! !

WARNING: Whenever riding a Meepo board, safety is your top priority. Loss of control, collisions, and falls may cause serious injury to you.

WARNING: Always wear a helmet when riding. Never ride in the rain, or on wet, slippery or uneven surfaces with steep hills, traffic, cracks, train tracks, gravel, rocks or any obstacles that could cause a loss of traction. Avoid night riding in areas with poor visibility or narrow spaces.

WARNING: Never ride the board at speeds where you do not feel comfortable. In the event of wireless interference or battery fault, you may need to rely on skating techniques like footbraking or sliding to stop. Here is a video for you to learn the skill.

<https://www.youtube.com/watch?v=l3EyJPm2E6s>.



WARNING: AVOID WATER!

Riding in wet conditions or through puddles can damage the board's electronics and cause the board to lose power or stop suddenly. Damage to the board due to water exposure is not covered under the warranty.



WARNING: PINCH POINTS

Keep fingers, hair, and clothing away from motors, wheels, and all moving parts.



WARNING: RISK OF ELECTRIC SHOCK!

Do not open or tamper the case or battery with cleaning products, this will void the board's warranty.

Please ride responsibly and respect those around you. How you ride will determine how people view this new mode of transportation. 😊

M5s REMOTE

1

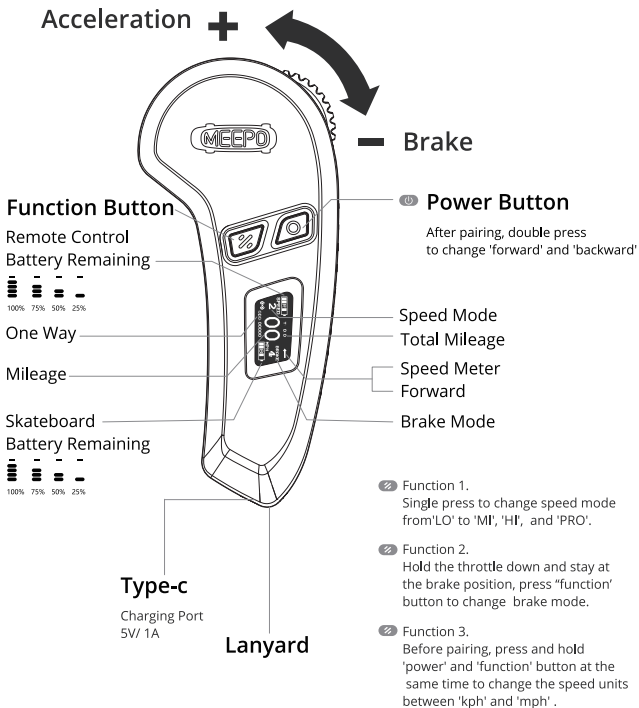

Pairing the Remote and Board

1. Turn on Meepo board, then long press the switch for 7 seconds.
2. Press the power button on the remote for 3 seconds to turn it on.
3. Press the power and function-button on the remote at the same time.



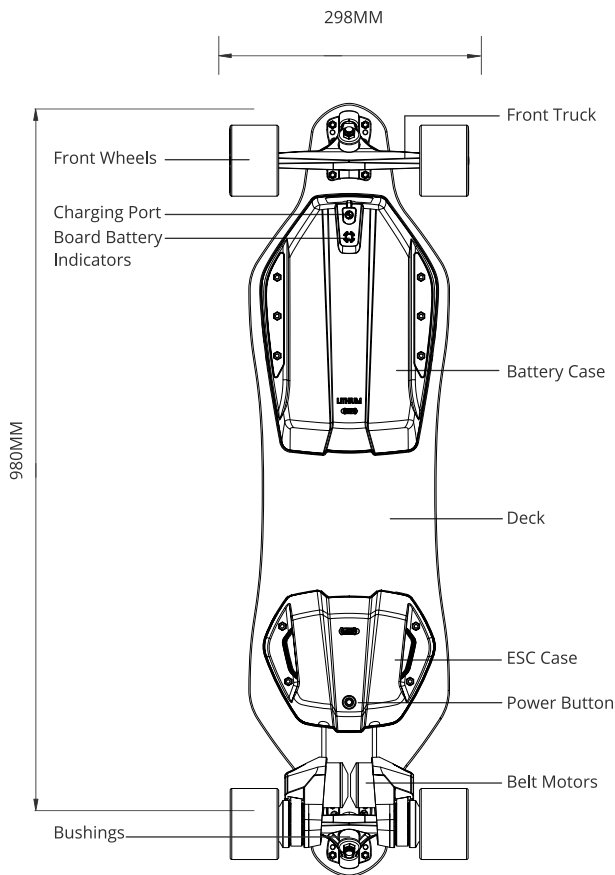

Get Ready to Ride

3

- Always wear a helmet.
- Find a flat, paved area with no obstacles for your first ride.
- Read and understand the entire manual.
- For more details, check out our website: www.meepoboard.com.
- Other protective equipment is highly recommended.



AVOID THESE OBJECTS AS THEY CAN MAKE YOU LOOSE CONTROL OR CRASH:

Gravel 	Water 	Uphill 	Downhill
Cracks 	Larger Rocks 	Tracks 	Grates/Drains
Traffic 	Night Time 	Obstacles 	Poor Visibility

ARE YOU A "REGULAR" OR "GOOFY" FOOTED RIDER?

Typically, if you kick a ball with your right foot, you are a regular footed rider. However, this is not always the case! Try both stances to see what feels best. If you don't know which to choose, one advantage of riding goofy footed is that you have a better view of the traffic.

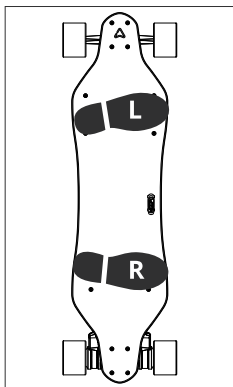

Regular

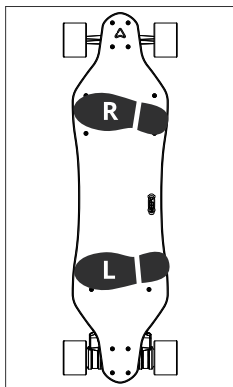

Goofy

STANCE

Your Meepo board has a lot of power. Follow these tips to ensure a safe riding experience:

- Move the throttle wheel in small increments.
- Keep a wide stance on the board.
- Keep a low center of gravity.
- Lean forward when accelerating.
- Lean backward when braking.



Power On/Off the Remote

5

Press the power-button
for 2 seconds

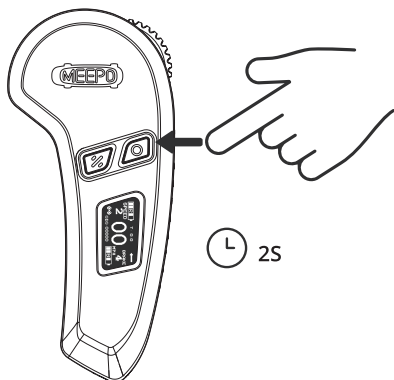

Power On/Off the Board

6

Press the power button once
or push-start the board.

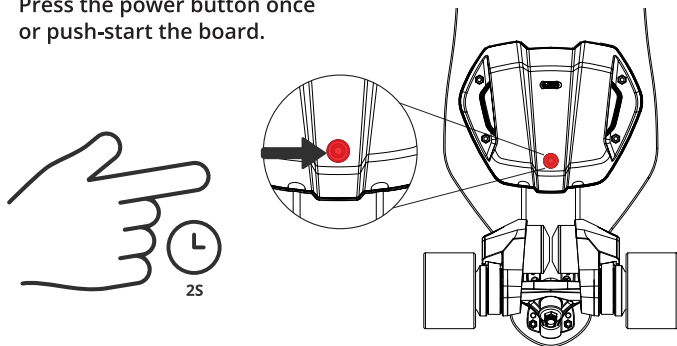

Check the Remote-Board Pairing*

7

* Your board and remote have already been paired in the factory. You need to do the following procedure when pairing a new remote to a board.

- Turn on the board by pressing the power button on the board once.
- Turn on the remote by long pressing the “power” button on the remote.

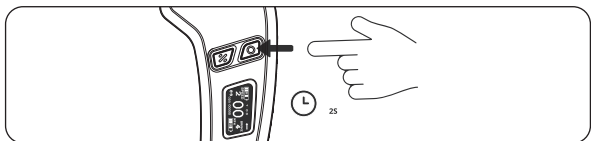

- Make sure the old remote is turned off, if you have one.
- Hold the power button on the board for 7 seconds.

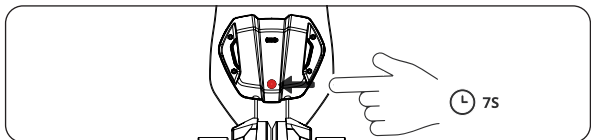

- Press the “power” and “function” buttons on the remote at the same time.

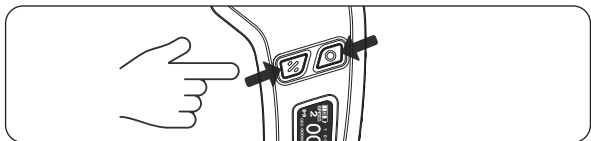

- The connection light on the remote will flash green light.
- When the power button blinks rapidly and the remote displays all the specs, the board and remote have been paired.

Operating the Board with the Remote

8

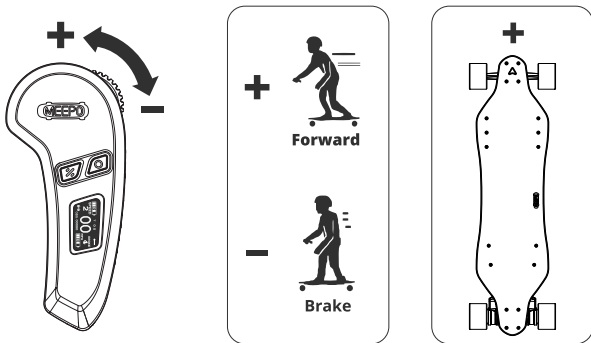

Check the Board Battery Life on the Remote

9

The remote is equipped with battery indicator lights below the power button.

When your remote's power on, the remote lights will indicate the power level.

**Skateboard
Battery Remaining**

(When the remote's power on)

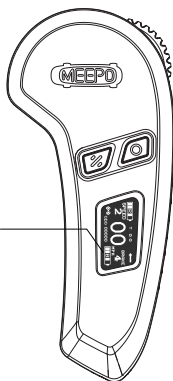

Change Ride Mode

10

The board is set in beginner mode by default. Before switching modes, make sure you have mastered the beginner mode.

LO: Limited acceleration.

MI: Moderate acceleration.

HI: High acceleration.

PRO: Max acceleration.

WARNING: The throttle wheel is much more sensitive in HI and PRO modes. To avoid getting thrown off from the board, follow these tips:

- Start by moving forward slowly.
- Move the throttle wheel in small increments.
- Keep a wide stance on the board.
- Keep a low center of gravity.
- Lean forward when accelerating.
- Lean backward when braking.



It usually takes the remote several hours to get fully charged. If the board and remote are charged at the same time, the remote will be charged first.

CYCLE THROUGH SPEED /BRAKE MODES:

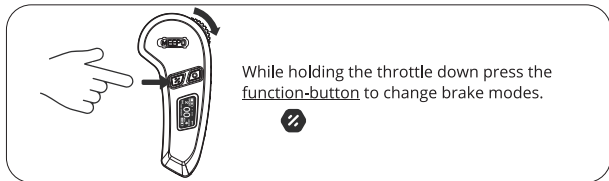
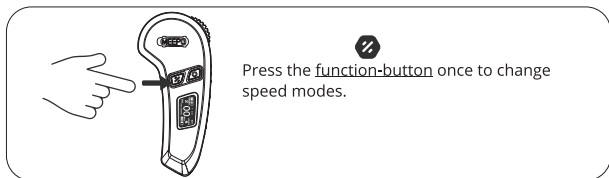

Charge the Remote

11

The remote takes several hours to charge. If the board and remote are charged at the same time, the remote should finish charging before the board.



Charge the Board

12

Warning: Never leave your board unattended while charging.

Press here to show your skateboard's battery remaining.

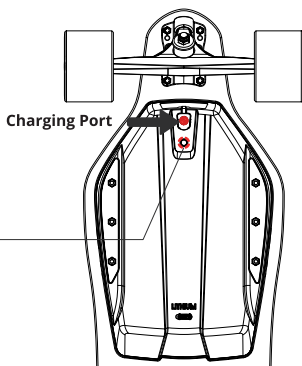

Remove the Battery Pack

13

- Ensure that the board is turned off.
- Take the grip tape off.
- Use a 3mm hex wrench to remove the six bolts that fasten the battery pack to the deck.
- Lift the battery pack to reveal the connector between the deck and battery pack.
- Carefully twist and pull the connector apart.

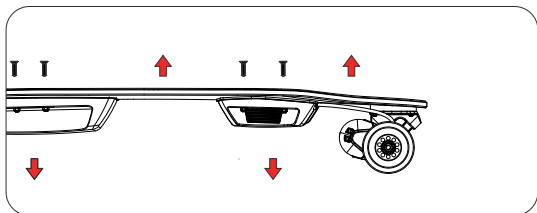

Replace the Battery Pack

14

- To insert a new battery pack, align the grooves on both ends of the connector (board & battery pack).
- Insert, connect, and adjust the two ends of the connector together. Make sure to tighten the connector to make a good seal.
- Ensure the connector lays flat within the accessory wire and the groove of the board.
- Replace and tighten the bolts with the hex wrench, and put the grip tape back on.

This manual is a quick start guide intended for someone with little experience in riding electric skateboards. If you want to learn more on how to start riding, superior riding skills, and solutions for riding problems, please visit our website: www.meepoboard.com or send us a mail to info@meepoboard.com.

GETTING STARTED

- How to stand on the board
- How to turn
- How to find a good spot to practice

ADVANCED TECHNIQUES

- How to footbrake
- How to ride uphill and downhill safely
- What to look for when riding through traffic

MAINTENANCE

- Pre-ride inspection
- Routine maintenance

Warnings and Safety Information

16

This equipment has been tested and complies with the limits for a Class B digital device, pursuant to part 15 of the FCC Rules.

These limits are designed to provide reasonable protection against harmful interference in a residential installation. This equipment generates, uses, and radiates radio frequency energy. If not installed and used in accordance with the instructions, it may cause harmful interference to radio communications. However, there is no guarantee that interference will not occur in a particular installation.

If this equipment does radiate harmful interference to radio or television reception, fix the problem by trying one or more of the following measures:

- Reorient or relocate the receiving antenna.
- Increase the separation between the equipment and receiver.
- Connect the equipment into an outlet on a different circuit from which the receiver is connected.
- Consult the dealer or an experienced radio/TV technician for help.

Prolonged exposure to sunlight may discolor or weaken the plastic cases, as they are not UV Rated.

Product Specifications

•Meepo Voyager Skateboard: Rated Input: 50.4V, 3A
M5s Remote:Rated Input: 5Vdc, 500-1000mA Operating
Temperature: 0-40°C,10-90% RH

•The board specifications were obtained under perfect conditions. Each customer will have different conditions that will make the eboard performance fluctuate from the data we present.

Battery Safety and Handling Information

CAUTION

Risk of explosion if battery is replaced by an incorrect type.
Dispose of used batteries according to instructions.

CAUTION

Failure to follow these safety instructions could result in fire, electric shock, or other injury or damage to the Meepo Voyager skateboard and Meepo M5s remote or other



IMPORTANT Safety and Handling Information

Do not attempt to disassemble the product without consulting Meepo. Should your unit need service, contact our Customer Service by sending an email to info@meepoboard.com.

Changes or modifications to the skateboard unapproved by Meepo may void the user's warranty.

This product is intended to be equipped only with Meepo Voyager batteries.

Do not drop or throw the battery.

Keep the battery away from kids.

Never expose this product or the battery to any liquids.

Never throw the battery into a fire, it could cause the battery to explode.

Never bring the connector terminals in contact with another metal object, it will short-circuit the battery. Short-circuit could cause personal injury, fires or damage to the battery.

Your device contains an internal rechargeable lithium-ion battery which may present a risk of fire or chemical burn if mistreated. Do not charge or use the unit in a car or places where the temperature surpasses 40°C.



Battery Charging Information

The charger supplied with the electric skateboard should be regularly examined for damage to the cord, plug, enclosure, and other parts. In the event of such damage, the skateboard must not be charged until the charger has been repaired or replaced.

Unplug the charger and disconnect it from the skateboard when not in use.

CAUTION

Only use the dedicated charger provided for this unit.

The charger is designed for indoor use only. Do not expose the charger to liquid, moisture or extreme humidity. Do not charge Meepo Voyager skateboard or Meepo M5s remote outdoors or in the rain.

WARNING

Power cord is used as a disconnection device. To fully de-energize equipment for service, disconnect the charger power cord.

Stop charging the skateboard and/or remote if charging isn't completed within the specified time.

Stop charging the skateboard and/or remote if the batteries become abnormally hot, show signs of odor, discoloration, deformation, or if abnormal conditions are detected during use, charging, or storage.

Do not charge the skateboard and/or remote if the battery enclosure becomes cracked, swollen, or shows any other signs of damage. Discontinue use immediately and promptly dispose of unit.

Product and Battery Disposal Information:

Your device should not be placed in municipal waste. Please check local regulations for proper disposal of electronic products.

If this unit shows any type of damage, such as bulging, swelling, or malformation, discontinue use and immediately contact Customer Service by sending a mail to info@meepoboard.com.

Dispose of used batteries in accordance with the prevailing community regulations that apply to the disposal of batteries.

Never dispose of used batteries with other ordinary solid wastes.

Batteries contain toxic substances.

WARRANTY AND MAINTENANCE

LIMITED WARRANTY

This board is covered by a 180 day manufacturer's warranty that covers defects in workmanship and material. This does not cover damage caused by abuse, misuse, negligence, accidents, or riding in water.

If the product has a manufacturing defect within 180 days of ship date, contact info@meepoboard.com

Each board was tested for at least 20 miles before shipping it out. So it is normal to spot some dirt or dust on the board, and certain mileage on the remote.

FOR ALL RETURN AND WARRANTY SHIPPING:

Please keep your shipping box. The warranty does not include damage from return shipping with lack of package material.

For any concerns regarding your board, please contact Meepo's customer service by going to www.meepoboard.com or by emailing info@meepoboard.com.

MAINTENANCE AFTER WET SURFACES

If you accidentally ride in the rain or on wet surfaces, wipe off all the water on the surface of your board, especially the charging port. Do not charge your board until it is completely dry. Then, run the motors so that the wheels are spinning for 10 minutes in order to dry the inside of the motors and avoid rust.

MAINTENANCE FOR UNUSED BOARD

Store your board in a dry area and fully charge your board at least once a month to avoid unrecoverable battery damage if you are not going to ride your board for a long time.

MEEPO Electric Skateboard Company

Company address: Room 2015, Trend Centre, 29-31 Cheung Lee Street, Chai Wan, Hong Kong

Online Store: www.meepoboard.com

Customer Service Email Address: info@meepoboard.com



Online Store



Customer Service



© MEEPO Inc. 2016-2022 www.meepoboard.com