

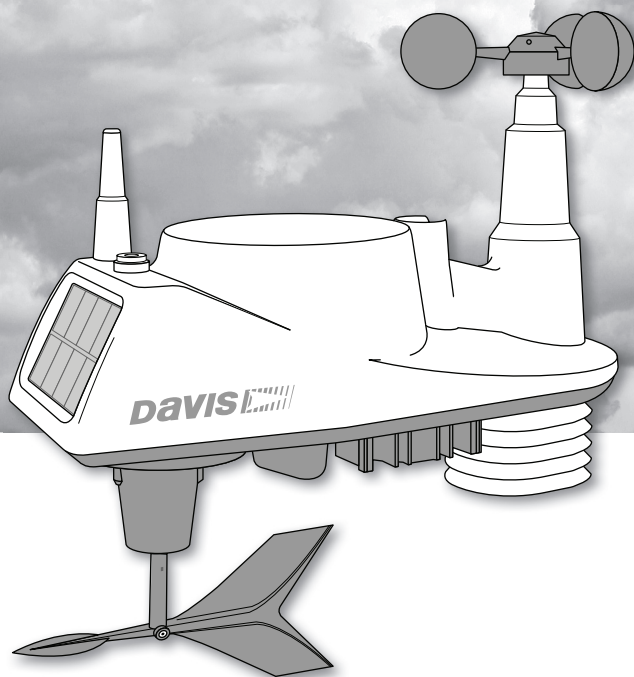

SOLUTIONS



Vantage VUE™

Sensor Suite
Installation Manual

Table of Contents

Introduction	1
Included Components and Hardware	1
Vantage Vue Sensor Suite Components	1
Hardware	2
Tools Needed	2
Preparing the Sensor Suite for Installation	2
Attach the Wind Cups to the Anemometer	3
Attach the Wind Vane	3
Install the Rain Collector Tipping Spoon Assembly	4
Install the Debris Screen	4
Install the Battery	4
Advanced Installations: Confirm the Transmitter ID	5
Advanced Installations: Set a New Transmitter ID	5
Verify Data from the Sensor Suite	6
Installing the Sensor Suite	7
Choosing a Location for the Sensor Suite	7
Sensor Suite Installation Guidelines	7
Mounting the Sensor Suite	8
Finishing the Installation	10
Maintenance and Troubleshooting	11
Appendix A: Specifications	14

FCC Part 15 Class B Registration Warning

This equipment has been tested and found to comply with the limits for a Class B digital device, pursuant to Part 15 of the FCC Rules. These limits are designed to provide reasonable protection against harmful interference in a residential installation. This equipment generates, uses, and can radiate radio frequency energy and, if not installed and used in accordance with the instructions, may cause harmful interference to radio communications. However, there is no guarantee that interference will not occur in a particular installation. If this equipment does cause harmful interference to radio or television reception, which can be determined by turning the equipment on and off, the user is encouraged to try to correct the interference by one or more of the following measures:

- Reorient or relocate the receiving antenna.
- Increase the separation between the equipment and receiver.
- Connect the equipment into an outlet on a circuit different from that to which the receiver is connected.
- Consult the dealer or an experienced radio/TV technician for help.

Changes or modification not expressly approved in writing by Davis Instruments may void the warranty and void the user's authority to operate this equipment.

FCC ID: IR2DWW6357

IC: 3788A-6357

This product (models 6250EU, 6250UK, 6357OV) complies with the essential protection requirements of the Radio Equipment Directive 2014/53/EU. The complete Declaration of Conformity is on our website at <https://www.davisinstruments.com/legal>. RoHS Compliant.



3465 Diablo Avenue, Hayward, CA 94545-2778 U.S.A.
510-732-9229 • Fax: 510-732-9188

Integrated Sensor Suite Installation Manual.

Rev. H, 5/13/19

Document Part Number: 07395.262

For Vantage Vue Weather Stations and Systems

Vantage Vue®, Vantage Pro2™, and Weather Envoy™ are trademarks of Davis Instruments Corp., Hayward, CA.

© Davis Instruments Corp. 2019. All rights reserved. Information in this document subject to change without notice. Davis Instruments Quality Management System is ISO 9001 certified.

Introduction

The Vantage Vue® wireless sensor suite collects outside weather data and sends the data wirelessly to a Vantage Vue console via a low-power radio. The sensor suite is solar-powered and includes a battery back-up.

The Vantage Vue sensor suite contains a rain collector, temperature/humidity sensor, anemometer, and wind vane. The temperature/humidity sensor is mounted in a passive radiation shield to minimize the impact of solar radiation on sensor readings. The anemometer measures wind speed, and the wind vane measures wind direction.

The Sensor Interface Module (SIM) is housed within the sensor suite and comprises the “brains” of the Vantage Vue system and the radio transmitter. The SIM collects outside weather data from the sensor suite sensors and transmits that data to your Vantage Vue console or WeatherLink Live.

Note: Your Vantage Vue sensor suite can transmit to an unlimited number of consoles, so you can purchase additional consoles to use in different rooms. It can also transmit to Davis Vantage Pro2 consoles and Davis Weather Envoys as well as Vantage Vue consoles.

Included Components and Hardware

Vantage Vue Sensor Suite Components

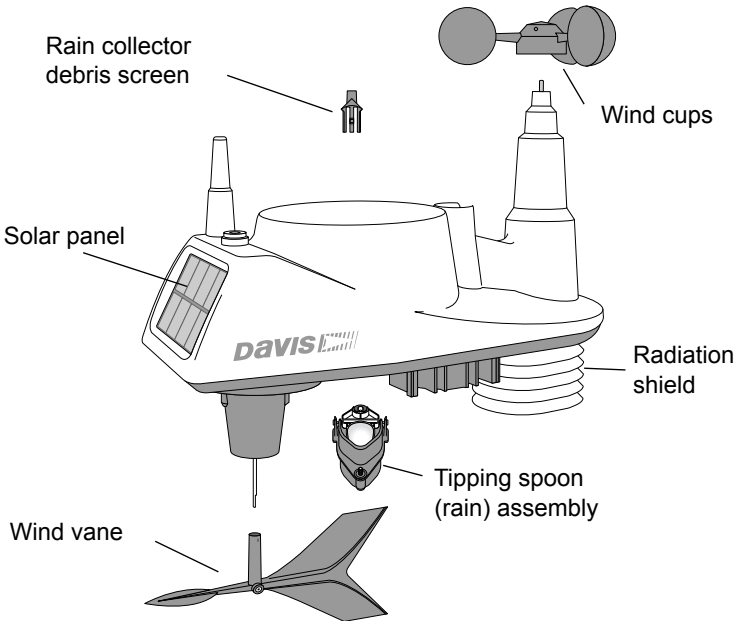

Hardware

Hardware included with the Vantage Vue sensor suite:

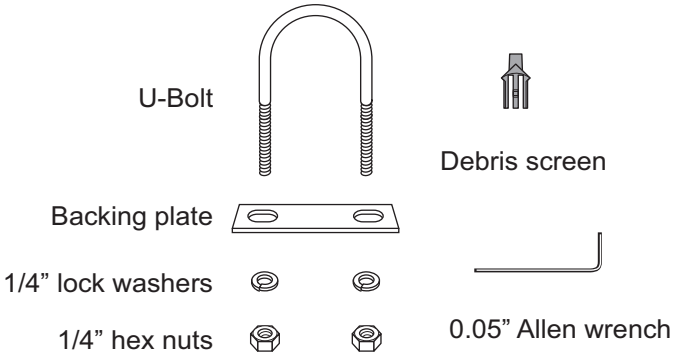

Note: If any of the hardware components are missing or not included, contact Customer Service toll free at 1-800-678-3669 about receiving replacement hardware or other components.

Tools Needed

- Adjustable wrench or 7/16" (11 mm) wrench
- Compass or local area map

Preparing the Sensor Suite for Installation

Follow the steps in the order; each builds on tasks completed in previous steps.

Note: Use a clean, well-lit work table or work area to prepare the sensor suite for installation.

1. Attach the wind cups to the anemometer.
2. Attach the wind vane.
3. Install the rain collector tipping spoon assembly.
4. Install the debris screen in the rain collector.
5. Apply power from the sensor suite battery.

Note: After this step, we recommend that you set up your console, and then come back to finish the installation of the sensor suite. See your *Vantage Vue Console Manual*.

Additional steps for advanced set up:

- Verify transmitter ID
 - Change the transmitter ID for wireless communication, if necessary
6. Verify data from the sensor suite.

Attach the Wind Cups to the Anemometer

The Vantage Vue anemometer measures wind speed. The wind cups are mounted on the anemometer shaft on the top of the sensor suite assembly.

1. Gently slide the wind cup assembly down onto the anemometer's stainless steel shaft as far as it will go, as shown.
2. Use the Allen wrench provided to tighten the set screw near the top of the "hub" section of the wind cups, as shown. Ensure that the set screw is screwed in fully and is tight.
3. Pull gently on the hub to ensure that the anemometer is securely fastened to the shaft.
4. Spin the wind cups to make sure they spin freely.

Install cups onto stainless steel shaft.

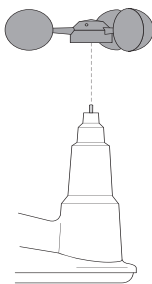

Tighten set screw with Allen wrench.

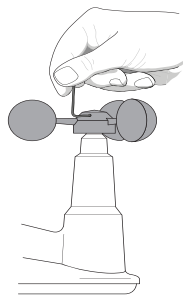

Note: If the wind cups don't spin freely, loosen the set screw, remove the wind cups from the shaft, and repeat the installation steps.

Attach the Wind Vane

The Vantage Vue wind vane measures wind direction. The wind vane is mounted on a stainless steel shaft on the opposite side of the sensor suite assembly from the wind cups.

1. Hold the sensor suite assembly on its side with the anemometer and radiation shields on your left, the wind vane shaft on your right and the wind cups away from you.
2. When the sensor suite is held in this manner, the wind vane shaft is horizontal, and will orient itself so that its flat side will be facing *to the right*, as shown.
3. Holding the sensor suite assembly with your left hand, grasp the wind vane with your right hand so that the "arrowhead" end is *pointed down*.
4. Gently slide the wind vane onto the wind vane shaft, rotating the wind vane slightly left and right if necessary, until the end of the shaft is visible and protrudes slightly from the bottom surface of the wind vane.
5. Secure the wind vane to the shaft by firmly tightening the wind vane set screw with the Allen wrench provided.

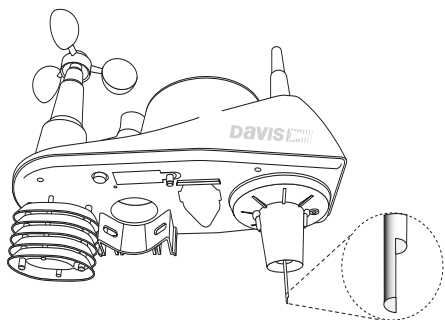

Install the Rain Collector Tipping Spoon Assembly

1. Locate the tipping spoon assembly slot on the underside of the sensor suite base.
2. Insert the wider end of the tipping spoon assembly into the slot first, sliding it under the raised lip of the slot.
3. Fit the narrow end into the slot and tighten the thumbscrew securely.

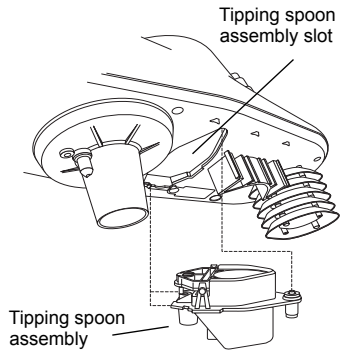

Install the Debris Screen

The Vantage Vue sensor suite rain collector debris screen captures debris that may otherwise clog your rain collector.

1. Locate the small black plastic sensor suite debris screen in your hardware package.

The debris screen has four small tabs that hold it in place in the base of the rain collector.

2. Holding the sensor suite assembly with one hand, and holding the debris screen by the top, press it into the opening in the rain collector until the tabs snap into the opening.

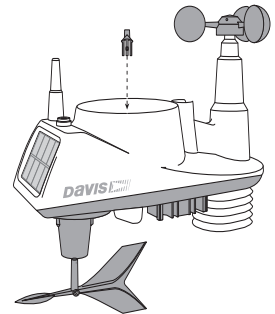

Apply Battery Power

The Vantage Vue sensor suite stores energy from the solar panel for power at night. A 3-volt lithium battery provides a backup power source. The battery compartment is located on the underside of the sensor suite base. The battery is shipped installed in the battery compartment with a battery pull tab to prevent battery power connection until set up.

1. Unscrew the thumbscrew to remove the battery compartment door.
2. Hold the battery so it does not fall out and remove the battery pull tab.

To verify power, wait 30 seconds then push and release the white transmitter ID button next to the battery compartment. The green transmitter ID LED next to the battery compartment will illuminate when you press the button.

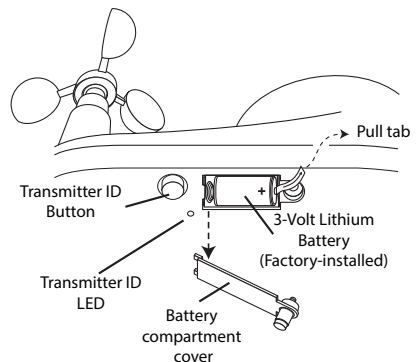

Note: Press the button once and release it. Do not press it multiple times or hold it down.

When you release the button, the LED will blink once (indicating transmitter ID 1), then begin to flash every 2.5 seconds to show transmission of a data packet. This flashing will stop within a few minutes to conserve battery life.

3. Replace the battery compartment door.

Note: If you have not already set up and powered your Vantage Vue console, do so before continuing with the sensor suite installation. For best reception, the console and sensor suite should be at least 10 feet (3 meters) apart.

4. The console acquires the radio signal and populates data fields. This usually occurs quickly, but in some environmental conditions it can take up to 10 minutes.

Advanced Installations: Confirm the Transmitter ID of the sensor suite

Your Vantage Vue console can be used to listen to a Vantage Pro2 sensor suite instead of a Vantage Vue sensor suite, and an optional anemometer transmitter kit.

Note: If you are using only the Vantage Vue console and sensor suite, and there are no other Davis weather stations nearby, you can skip to “Verify Data from the Sensor Suite” on page 6.

In order to communicate, the console and sensor suite must have the same transmitter ID. At the factory, both IDs are set to a default of ID 1. To confirm the transmitter ID of your Vantage Vue sensor suite:

1. Push and release the transmitter ID button once. It will illuminate and go off when you release it.
2. After a short pause, it will blink one or more (up to 8) times. Note the number of times the transmitter ID LED blinks, which indicates its transmitter ID number.

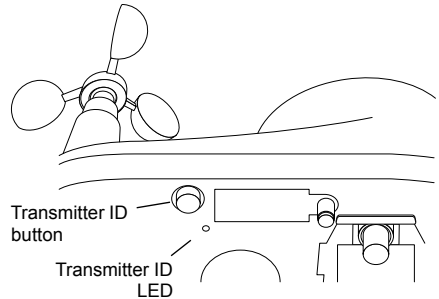

Unless you have intentionally changed your transmitter ID, the LED should blink *one time* because the default transmitter ID for the sensor suite is 1. If you have changed the ID, the LED should blink the number of times equal to the ID you have set (i.e., twice for an ID of 2, three times for an ID of 3, etc.).

After blinking the transmitter ID, the light will begin to flash every 2.5 seconds, indicating packet transmission.

Note: The transmitter on the sensor suite and receiver on the console will communicate with each other only when both are set to the same transmitter ID.

Note: If you hold the button too long and accidentally enter the “set new transmitter ID” mode when you did not want to, simply release the button and wait four seconds. As long as you do not press the button again, the original transmitter ID will remain in effect.

Advanced Installations: Set a New Transmitter ID on the Sensor Suite

Note: In most cases, it will not be necessary to change the transmitter ID. If it is necessary to change the transmitter ID, **you must use the same ID for the sensor suite and console.**

The Vantage Vue sensor suite transmits weather information to the Vantage Vue console using one of eight selectable transmitter IDs. The default transmitter ID for both the sensor suite and the Vantage Vue console is 1. Change the transmitter ID if another Davis Instruments wireless weather station is operating nearby and already uses transmitter ID 1, or if you have an optional Anemometer Transmitter Kit with ID 1.

To set a new transmitter ID:

-
1. Push and hold the transmitter ID button until the LED begins flashing quickly. This indicates it is in the setup mode.
 2. Release the button, and the LED will go dark.
 3. Push the button the number of times equal to your desired new transmitter ID. That is, if you want to change the ID to 3, push the button three times; for a desired ID of 4, push the button four times.

After four seconds have elapsed with no further presses, the LED will blink the same number of times as the new transmitter ID. (After blinking the transmitter ID number, the light will begin to flash each time a packet is transmitted, about every 2.5 seconds.)

Verify Data from the Sensor Suite

To verify reception of sensor suite data by the Vantage Vue console, you will need your powered-up console and the sensor suite. For best reception, the console and sensor suite should be at least 10 feet (3 meters) apart.

1. If the console is in Setup Mode, press and hold **DONE** until the Current Weather screen displays. The antenna icon appears under the wind compass rose. Watch this icon to see that “transmission waves” appear, indicating reception of a packet.
Sensor readings from the sensor suite should display on the screen within a few minutes.
2. At the top right corner of the screen, look for the outside temperature.
3. Gently spin the wind cups to check wind speed, pressing the **WIND** button on the console to alternate between speed and direction in the wind rose.
4. Gently turn the wind vane, and allow 5 seconds for the wind direction display to stabilize before moving it again.

Note: A good way to ensure that your console is listening to your sensor suite and not another Davis station nearby, is to make sure the wind values displayed match your wind vane's direction in reference to the solar panels, which are assumed to be facing south. For example, if you move the vane to point directly away from the radiation shield, the console should show a wind direction of south; if you then turn the vane 180° so it is pointed back at the radiation shield, the wind direction on the console should change to north.

5. Approximately one minute after acquisition of the signal, the outside relative humidity reading should be displayed on the console, below the outside temperature display.
6. Confirm rain display. On your console screen, select the RAIN DAY display. (See *Vantage Vue Console Manual*.) Carefully hold your sensor suite over a sink and, while watching the RAIN DAY display on your console, slowly pour one-half cup of water into the Rain Collector. Wait two seconds to see if the display registers a rain reading.

Note: This method confirms that the rain display is functioning. It **cannot** be used to verify accuracy.

7. Current data displayed on the console confirms successful communication.

Note: In some cases it may take as long as ten minutes for a reading to register on your console.

If communication problems exist between the wireless sensor suite and the console, see “Troubleshooting Sensor Suite Reception” on page 12.

Installing the Sensor Suite

Choosing a Location for the Sensor Suite

The sensor suite assembly includes the rain collector, wind vane, anemometer, temperature and humidity sensors, radiation shield, and SIM housing. You will use the U-bolt and associated nuts and washers that are included with your sensor suite mounting hardware package to install the sensor suite on a pole. (See “Hardware” on page 2.)

To ensure that the Vantage Vue weather station performs at its best, use these guidelines to select the optimum mounting location for the sensor suite. Be sure to take into consideration ease of access for maintenance and wireless transmission range when siting the station.

Note: When selecting a location for installing your sensor suite, especially on a rooftop, make sure it is a location far from power lines. Seek professional help if you are uncertain about the safety of your installation.

Sensor Suite Installation Guidelines

Note: These siting guidelines reflect an ideal condition. Rarely is it possible to create the perfect installation. The better the siting, the more accurate your data will be.

- Place the sensor suite away from sources of heat such as chimneys, heaters, air conditioners, and exhaust vents.
- Place the sensor suite at least 100' (30 m) away from any asphalt or concrete roadway that readily absorbs and radiates heat from the sun. Avoid installations near fences or sides of buildings that receive a lot of sun during the day.
- Install the sensor suite as level as possible to ensure accurate rain and wind measurements. Use the built-in bubble level on the top of the sensor suite, just above the solar panel, to make sure the sensor suite is level.
- In the Northern Hemisphere, the solar panel should face south for maximum sun exposure.
- In the Southern Hemisphere, the solar panel should face north for maximum sun exposure.

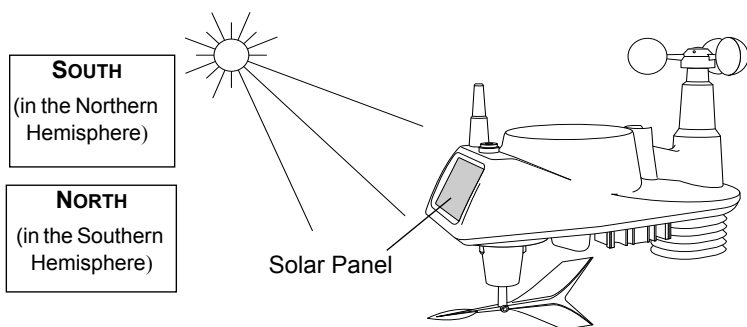

Note: The wind direction is calibrated assuming the solar panel is facing south. If you install the sensor suite with the solar panel pointing in a direction other than south, you will need to use the wind direction calibration function in the Vantage Vue console in order to obtain accurate wind direction readings. See *Vantage Vue Console Manual* for more information.

- Ideally, mount the sensor suite so that it is between 5' (1.5 m) and 7' (2.1 m) above the ground in the middle of a gently sloping or flat, regularly mowed grassy or naturally landscaped area that drains well when it rains. You can also mount the sensor suite on the roof, between 5' (1.5 m) and 7' (2.1 m) above the roof surface. For areas with average maximum yearly snow depths over 3' (0.9 m), mount the sensor suite at least 2' (0.6 m) above this depth.
- Never install the sensor suite where it will be directly sprayed by a sprinkler system.
- Avoid installations near bodies of water such as swimming pools or ponds.
- Do not locate the sensor suite under tree canopies or near the sides of buildings that create "rain shadows." For heavily forested areas, site the sensor suite in a clearing or meadow.
- Site the sensor suite in a location with good sun exposure throughout the day.
- *For agricultural applications:*
 - Install the sensor suite so that it is between 5' (1.5 m) and 7' (2.1 m) above the ground and in the middle of the farm between similar crop types (such as two orchards, two vineyards, or two row crops), if possible.
 - Avoid areas exposed to extensive or frequent applications of agricultural chemicals (which can degrade the sensors).
 - Avoid installation over bare soils. The sensor suite performs best when installed over well-irrigated, regularly mowed grass
 - If the last three guidelines cannot be met, install the sensor suite at the edge of the primary crop of interest.

Siting guidelines that may affect the anemometer

- For optimal wind data, mount the sensor suite so that the wind cups are at least 7' (2.1 m) above obstructions such as trees or buildings that may obstruct wind flow.
- For optimal wind data, you may mount the sensor suite on a roof, keeping in mind ease of access to the sensor suite for maintenance and safety considerations. Ideally, mount it so that the wind cups are at least 7' (2.1 m) above the roof apex.
- The standard for meteorological and aviation applications is to place the anemometer 33' (10 m) above the ground. Seek professional help for this such installation.
- The standard for *agricultural applications* is to place the wind cups 6' (2 m) above the ground. This is important for evapotranspiration (ET) calculations.

Note: For roof mounting, and ease of installation, we recommend using the optional tripod (#7716). For other installations, use the Mounting Pole Kit (#7717).

Note: For more detailed siting suggestions, see Application Note #30 on the Davis Support website (<http://www.davisinstruments.com/support/weather>).

Mounting the Sensor Suite

The Vantage Vue sensor suite can only be mounted on the top of a pole or rod.

Note: A mounting pole is not included with your Vantage Vue sensor suite and must be purchased separately, either from Davis Instruments or from your local hardware retailer.

Recommended Accessories for Pole Mounting

- Use the Mounting Tripod (#7716) for easiest mounting.
- Use the Mounting Pole Kit (#7717) to raise the installation height of the sensor suite by up to 37.5" (0.95 m).

General Guidelines for Installing on a Pole

- With the supplied U-bolt, the sensor suite can be mounted on a pole or rod having an outside diameter ranging from 1" to 1.75" (25 – 44 mm).
- To mount on a smaller pole, obtain a U-bolt that fits the base openings but that has a longer threaded section. If mounting the sensor suite on a smaller pole with the included U-bolt, the threaded sections of the U-bolt will be too short to securely mount the sensor suite.

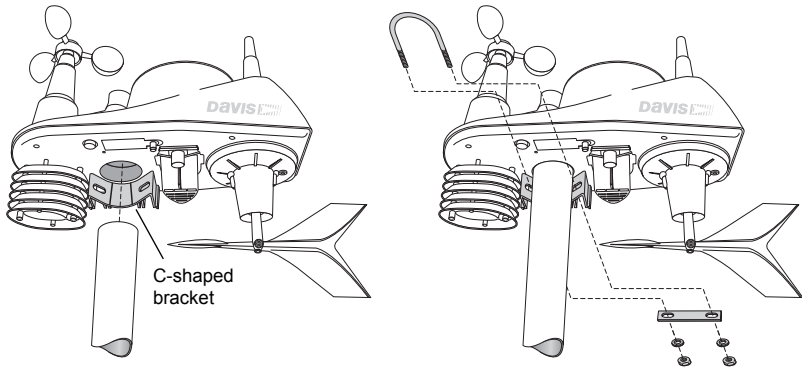

Installing the Sensor Suite on a Pole

1. If you are mounting your sensor suite on a Davis Mounting Tripod or the pole included with a Davis Mounting Pole Kit, follow the instructions included with those Davis products for proper installation.

If you are not using one of these Davis products, mount on a galvanized steel pole having an outside diameter ranging from 1" to 1.75" (25 – 44 mm).

Note: It is important that the mounting pole be plumb. You may wish to use a level such as a magnetic "torpedo level" to assure that the sensor suite, when mounted on top of the pole, will be level.

2. Using the illustration above as a guide, hold the sensor suite so that the wind cups and radiation shield are on the left and gently place the sensor suite on top of the pole.
3. While holding the mounting base of the sensor suite against the pole, place the two ends of the U-bolt around the pole and through the two holes in the C-shaped bracket on the base.
4. Slide the metal backing plate over the bolt ends where they extend out from the far side of the bracket.
5. Secure the backing plate with a lock washer and hex nut on each of the bolt ends, as shown in the illustration.
6. Tighten the hex nuts **with your fingers only** so that the sensor suite is just secure enough on the pole for you to release your grip.

7. If you are in the Northern Hemisphere, rotate the sensor suite on the pole so that the solar panel is facing south; if you are in the Southern Hemisphere, rotate the sensor suite so that the solar panel is facing north. The more precisely the solar panels face due south or north, the more accurate your wind direction readings will be.

Note: Do not rely on a compass unless it is properly calibrated. In North America there can be up to 15° variation between true north and a raw compass reading.

8. When the sensor suite is properly oriented, tighten the hex nuts with a wrench. Do not exceed 96 inch-pounds (10.8 newton-meters) of torque.

Note: You can refer to the bubble level on the top of the sensor suite to make sure it is as level as possible.

Finishing the Installation

The wind vane is calibrated at the factory to be accurate when the solar panel is pointing south. If your solar panel does not point south, you must calibrate your console so that it displays accurate wind direction readings. In any case, you can also calibrate your console to fine-tune your station for greatest accuracy. Refer to your *Vantage Vue Console Manual* to calibrate your console.

Note: Calibration **must** be done if you are in the Southern Hemisphere, or if you are in the Northern Hemisphere and cannot install your sensor suite with the solar panel facing south.

Clearing Data Collected During Testing and Installation

Now that the sensor suite is mounted outside, any data that was collected and stored in the console during testing and mounting should be cleared.

To clear all the collected data on the console:

1. On the console, press **WIND** so that selection arrow appears adjacent to the wind data on the display. Confirm that wind speed is displayed on the compass rose.
2. Press **2ND**, then press and hold **CLEAR** for at least six seconds and until you see “CLEARING NOW” in the weather center.

Maintenance and Troubleshooting

Maintenance

Cleaning the Radiation Shield

The outer surface of the radiation shield should be cleaned when there is excessive dirt and build-up on the plates. Use a damp cloth to clean the outer edge of each ring.

Note: Spraying down or using water excessively to clean the radiation shield can damage the sensitive sensors or alter the data the sensor suite is transmitting.

Check the radiation shield for debris or insect nests at least once a year and clean when necessary. A buildup of material inside the shield reduces its effectiveness and may cause inaccurate temperature and humidity readings.

1. Using a Phillips head screwdriver, loosen the two #6 x 2 1/2" screws holding the five radiation shield plates together, as shown.
2. Taking care to maintain the order in which the five plates are assembled, separate the plates as shown and remove all debris from inside the shield.
3. Reassemble the plates in the same order in which they were disassembled, and fasten them together using a Phillips head screwdriver to tighten the #6 x 2 1/2" screws, as shown.

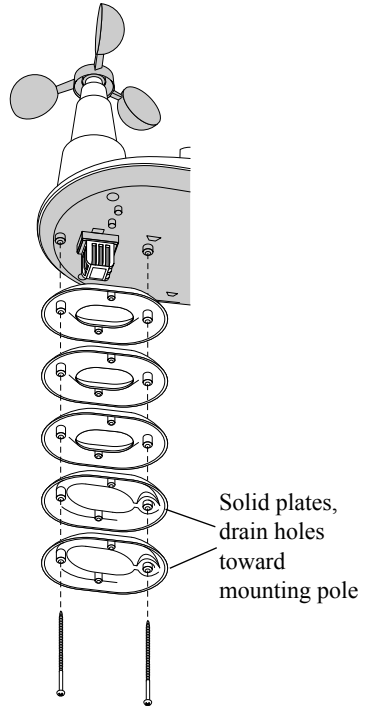

Cleaning the Rain Collector, Debris Screen, and Tipping Spoon Module

To maintain accuracy, thoroughly clean the rain collector cone and debris screen as needed or at least once a year.

Note: Cleaning the rain collector and tipping spoon may cause false rain readings. See "Clearing Data Collected During Testing and Installation" on page 10.

1. Use a damp, soft cloth to remove any debris from the rain collector and debris screen.
2. Use pipe cleaners to clear any debris remaining in the screen.
3. When all parts are clean, rinse with clear water.

To clean the tipping spoon assembly, it must first be removed from the sensor suite base.

1. Unscrew the thumbscrew securing the tipping spoon assembly to the sensor suite base. Slide the assembly down and away from the base.
2. Use a damp, soft cloth to gently remove any debris from the tipping spoon assembly, being careful not to damage any moving parts or scratch the spoon.
3. When all parts are clean, rinse with clear water, and replace the assembly. (See “Install the Rain Collector Tipping Spoon Assembly” on page 4.)

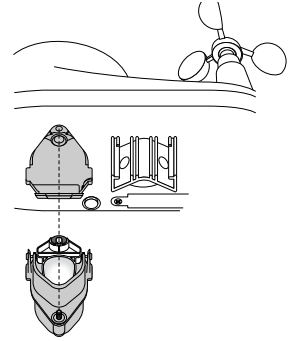

Troubleshooting

Troubleshooting Sensor Suite Reception

If the console isn't displaying data from the sensor suite:

1. Verify that the sensor suite and console are powered and that the console is not in Setup Mode. (See *Vantage Vue Console Manual*.)
2. Make sure that the sensor suite battery is properly installed.
3. Walk around the room with the console, standing for a few moments in various locations, to see if you are picking up signals from the sensor suite. Look on the screen below the wind compass rose for the small graphic of a radio antenna.

Note: If you do not see the antenna icon, press 2ND and SETUP to enter Setup Mode, then press DONE to return to the Current Weather Screen. The icon should appear.

4. Small “transmission waves” display above the antenna icon and toggle on and off when the console receives a transmission.

If you do not see the antenna's transmission wave graphic slowly blinking, regardless of where you stand with the console, you should call Technical Support.

5. If the Transmitter ID LED does not light after pressing the transmitter button, there is a problem with the sensor suite transmitter. Call Technical Support.
6. If, after pressing the Transmitter Pushbutton, the Transmitter ID LED flashes every 2.5 seconds (indicating transmission) but your console isn't picking up a signal anywhere in the room, it could be related to one of the following causes:
 - You changed the sensor suite Transmitter ID of the sensor suite or console, but not for both.
 - Reception is being disrupted by frequency interference from outside sources, or the distance and barriers are too great.

Note: Interference has to be strong to prevent the console from receiving a signal while in the same room as the sensor suite.

- There is a problem with the Vantage Vue console.
7. If a problem with receiving the wireless transmission still exists, please contact Technical Support.

Note: See “Contacting Davis Instruments” on page 13.

Problems Using Two Transmitting Stations

A single Vantage Vue console can receive signals from one sensor suite, either a Vantage Vue or a Vantage Pro2 sensor suite, and an optional anemometer transmitter kit. Make sure the transmitter IDs are configured correctly. See your *Vantage Vue Console Manual* for information on configuring transmitter IDs.

Most Common Rain Collector Problem

“My rain data seems too low.”

If the rain collector seems to be under-reporting rainfall, clean the debris screen and tipping spoon module to clear out any debris.

Most Common Anemometer Problems

“The wind cups are spinning but my console displays 0 mph.”

The wind cups may not be turning the shaft. Remove the cups from the anemometer by loosening the set screw. Put the cups back onto the shaft and make sure to slide them down the shaft as far as possible. Re-tighten the set screw.

“The wind cups don’t spin or don’t spin as fast as they should.”

The anemometer may be located where wind is blocked by something, or there may be friction interfering with the cups’ rotation. Remove the wind cups by loosening the set screw, and clear out any insects or debris which may be interfering with the cup rotation. Turn the shaft the cups rotate on. If it feels gritty or stiff, contact Davis Technical Support.

Note: Do not lubricate the shaft or bearings in any way.

“Readings aren’t what I expected them to be.”

Comparing data from your sensor suite to measurements from TV, radio, newspapers, or a neighbor is NOT a valid method of verifying your readings. Readings can vary considerably over short distances. How you site the sensor suite and anemometer can also make a big difference. If you have questions, contact Davis Technical Support.

Contacting Davis Instruments

If you have questions about the sensor suite or Vantage Vue system, or encounter problems installing or operating the weather station, please contact Davis Technical Support.

Note: Please do not return items to the factory for repair without prior authorization.



☎ 00 353 (0) 61 603 742

✉ info@hhsolutions.ie

🌐 www.hhsolutions.ie



Appendix A: Specifications

See complete specifications for your Vantage Vue station on our website:
www.davisnet.com

Integrated Sensor Suite (ISS) Specifications

Operating Temperature.....	-40° to +150°F (-40° to +65°C)
Non-operating (Storage) Temperature	-40° to +158°F (-40° to +70°C)
Current Draw (ISS SIM only).....	0.20 mA (average), 30 mA (peak) at 3.3 VDC
Solar Power Panel (ISS SIM).....	0.5 Watts
Battery (ISS SIM).....	CR-123 3-Volt Lithium cell
Battery Life (3-Volt Lithium cell)	8 months without sunlight - greater than 2 years depending on solar charging
Wind Speed Sensor	Wind cups with magnetic detection
Wind Direction Sensor	Wind vane with magnetic encoder
Rain Collector Type	Tipping spoon, 0.01" per tip (0.2 mm with metric rain cartridge, Part No. 7345.319), 18.0 in ² (116 cm ²) collection area
Temperature Sensor Type	PN Junction Silicon Diode
Relative Humidity Sensor Type	Film capacitor element
Housing Material.....	UV-resistant ABS & ASA plastic

Update Interval by Sensor		
BAR	Barometric Pressure	1 min.
HUMIDITY	Inside Humidity	1 min.
	Outside Humidity	50 sec.
	Dew Point	10 sec.
RAIN	Rainfall Amount	20 sec.
	Rain Storm Amount	20 sec.
	Rain Rate	20 sec.
TEMPERATURE	Inside Temperature	1 min.
	Outside Temperature	10 sec.
	Heat Index	10 sec.
	Wind Chill	10 sec.
WIND	Wind Speed	2.5 sec.
	Wind Direction	2.5 sec.
	Direction of High Speed	2.5 sec.