



ACCUR8

User Manual

**ACCUR8 DWS7100
Weather Station**

ACCUR8
Ford Lane Business Park
Ford
West Sussex
BN18 0UZ
UK

www.accur8tech.com

ACCUR8 is a registered trademark of Tempcon Instrumentation Ltd

Disclaimer

ACCUR8 products are designed to monitor current and previous weather conditions for domestic use and should not be considered as predictive weather forecasting equipment. Contact your regional Met Office centre if you need weather forecasting data

ACCUR8 products are tested for operation and functionality but have not been independently tested by a UKAS accredited laboratory. As part of our ongoing policy to improve the design and specification of our products, we reserve the right to change any detail given without prior notice. Tempcon Instrumentation Ltd shall not be responsible for any liability of any nature which may result from the use of any information provided in technical literature.

Errors and technical changes excepted.

© 2021 Tempcon Instrumentation Ltd.

All rights reserved.

Reproduction of this document, including extracts, in any form (photocopied, printed etc.) or the use and distribution of this document by electronic means (image file, website etc.) is not permitted without the prior written consent of Tempcon Instrumentation Ltd.

The designations and brand names of the respective companies used in this documentation are generally protected by trade, trademark and/or patent law.



For Sales & Service Contact

 00 353 (0) 61 603 742

 info@hhsolutions.ie

 www.hhsolutions.ie



Contents

1.	Introduction	3
2.	General Safety Instructions	3
3.	Getting Started.....	5
4.	Weather Station Installation.....	16
5.	Display Console Operation	21
6.	Registration with Weather Server Websites	28
7.	Wi-Fi Setup (Connect your Device to the Console's Wi-Fi).....	39
8.	Upgrade firmware	45
9.	Other Console Features	47
10.	Specifications.....	50
11.	Maintenance	52
12.	Troubleshooting Guide	53
13.	Adjustment or Calibration	55
14.	Service	59
15.	EC Declaration of Conformity	59
16.	UKCA Declaration of Conformity	59
17.	Disposal	59

1. Introduction

Thank you for purchasing the ACCUR8® DWS7100 Wi-Fi Weather Station with 7-in-1 Outdoor Sensor. The following user manual provides step-by-step instructions for installation, operation and troubleshooting.

This user manual is to be considered a component of the device. Read carefully before using the device. Keep in a safe place for future reference. When the device is sold or given to someone else, the user manual must be provided to the new owner/user of the product.

2. General Safety Instructions

Risk of electric shock

Any metal object may attract a lightning strike, including your weather station mounting pole. Never install the weather station in a storm.

This device has electronic parts operated via a power source (power supply and/or batteries). Improper use of this product can cause an electric shock. An electric shock can cause serious or potentially fatal injuries. The following safety information must be observed at all times:

- Children must only use the device under adult supervision. Only use the device as described in the manual; otherwise, you run the risk of an electric shock.
- Disconnect the device from the power supply before starting any maintenance or cleaning of the device.
- Position your device so that it can be disconnected from the power supply at any time. The power socket should be installed near the device and should be easily accessible as the mains cable plug is used to disconnect the device from the power supply.
- Before starting up the device, check the device, the cables and the connections for signs of damage.
- To disconnect the device from the power supply, always pull on the plug. Never pull on the cable.
- Never use a damaged device or a device with damaged live parts. Damaged parts must be replaced by an authorised service company.
- Only use the display console in a completely dry environment and do not touch it with wet or moist parts of your body.

Risk of suffocation/choking

Improper use of this product can result in suffocation, especially for children. The following safety information must be observed at all times.

- Keep packaging materials (plastic bags, rubber bands etc.) away from children. They can cause suffocation.
- This product contains small parts that could be swallowed by children. There is a risk of choking.

Risk of explosion

Improper use of this product can cause an explosion. The following safety information must be observed at all times to prevent an explosion.

- Do not expose the device to high temperatures. Use only the supplied power supply or the recommended batteries. Do not short-circuit the device or batteries or throw them into a fire. Excessive heat or improper handling could trigger a short circuit, a fire, or an explosion.

Risk of damage to property

Improper handling can result in damage to the device and/or to the accessories. Always observe the following safety information when using the device:

- Never disassemble the device. In the event of a fault, please contact your retailer.
- Do not expose this device to high temperatures and protect it from water and high humidity.
- Do not immerse the unit in water.
- Protect the device from severe shocks or excessive vibrations.
- For this device, only use accessories and spare parts that comply with the technical information.
- Use only the recommended batteries. Always replace weak or empty batteries with a new, complete set of batteries at full capacity. Do not use batteries from different brands or with different capacities. Remove the batteries from the unit if it has not been used for a long time.
- Rechargeable batteries are not recommended.

Risk of voltage damage

The manufacturer is not liable for voltage damage due to improperly inserted batteries or through the use of an improper power adaptor.





3. Getting Started

The DWS7100 weather station consists of a display console (receiver), a sensor array with integrated outdoor transmitter, a thermo-hygrometer transmitter, and mounting hardware.

3.1 Parts List

The DWS7100 weather station consists of the following parts (as referenced in Figure 1 below).

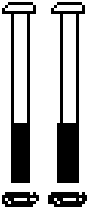
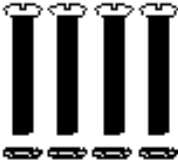
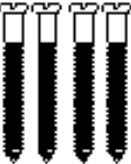
QTY	Item	Image
1	Display console Frame dimensions (L x H x W): 215 x 22 x 158mm LCD dimensions (L x W): 170 x 125mm	
1	Integrated outdoor transmitter Dimensions (L x H x W): 330 x 150 x 280mm	
1	Thermo-hygrometer transmitter (FT007TH) Dimensions (L x H x W): 114.5 x 50.0 x 19mm	
1	Foot mounting (with pole insert) Dimensions: 84x 152 x 216mm	

QTY	Item	Image
1	Mounting bracket back plate (pole mount) Dimensions: 76 x 102 x 38mm	
1	Mounting pole Dimensions: 76 x 76 x 25mm	
2	Pole mounting nuts (M3) / bolts Ø3)	
4	Pole mounting nuts (M5) / bolts (Ø5)	
4	Tapping screws	
1	User manual	

QTY	Item	Image
1	UK power adaptor	

Figure 1

3.2 Recommended Tools

- Phillips screwdriver
- Compass or GPS (for wind direction calibration)
- Adjustable spanner
- Hammer and nail for hanging remote thermo-hygrometer transmitter.

3.3 Sensor Assembly Set Up

Figure 2 shows the sensors included in the Integrated Outdoor Transmitter.

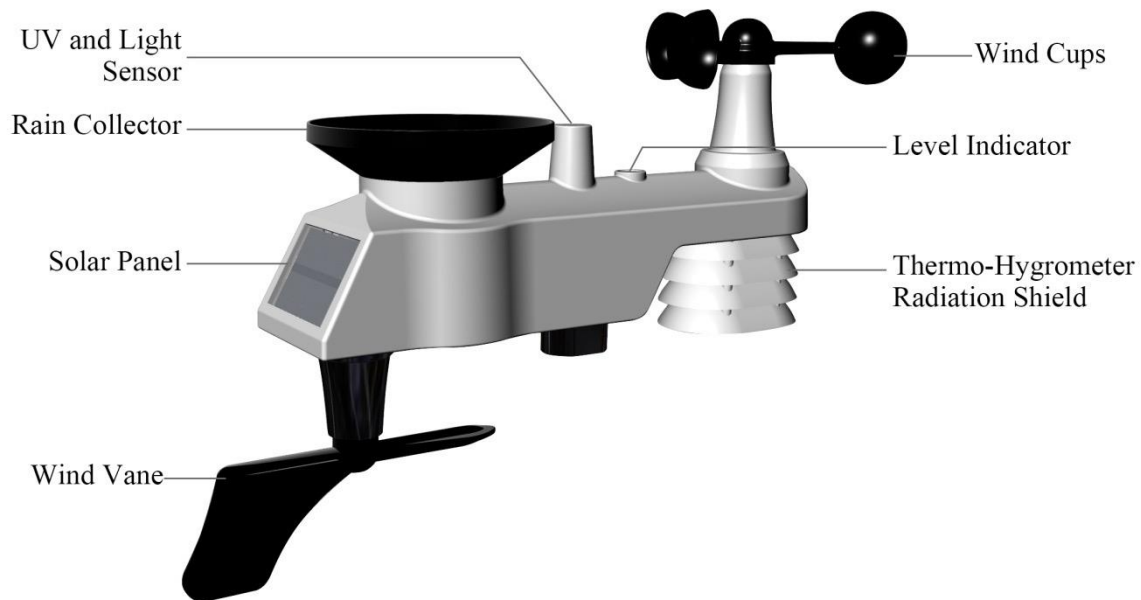

Figure 2

Insert batteries into the transmitter. Locate the battery door on the transmitter, push and open the battery compartment, as show in Figure 3.

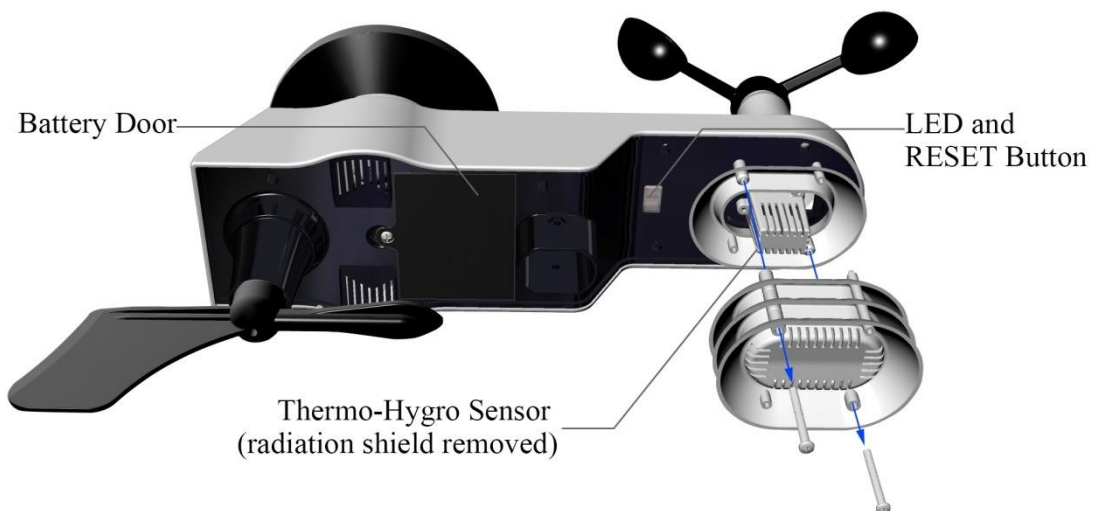

Figure 3

Remove the battery door by removing the set screw, as shown in Figure 4.



Figure 4

Insert 3 x AA batteries in the battery compartment, as show in Figure 5.



Figure 5

Close the battery door. Make sure the gasket (around the battery compartment) is properly seated prior to closing the door. Tighten the set screw.

 **Note:** Do not install the batteries backwards. You can permanently damage the sensors. The solar panel does not charge the batteries, so rechargeable batteries are not needed or recommended.

 **Note:** We recommend installing Lithium AA batteries for sensors.

The sensor LED indicator will light for 3 seconds, and then flash once per 16 seconds thereafter. Each time it flashes, the sensor is transmitting data.

 **Note:** If the sensor does not power up after inserting the batteries, press the Reset button shown in Figure 6 below.

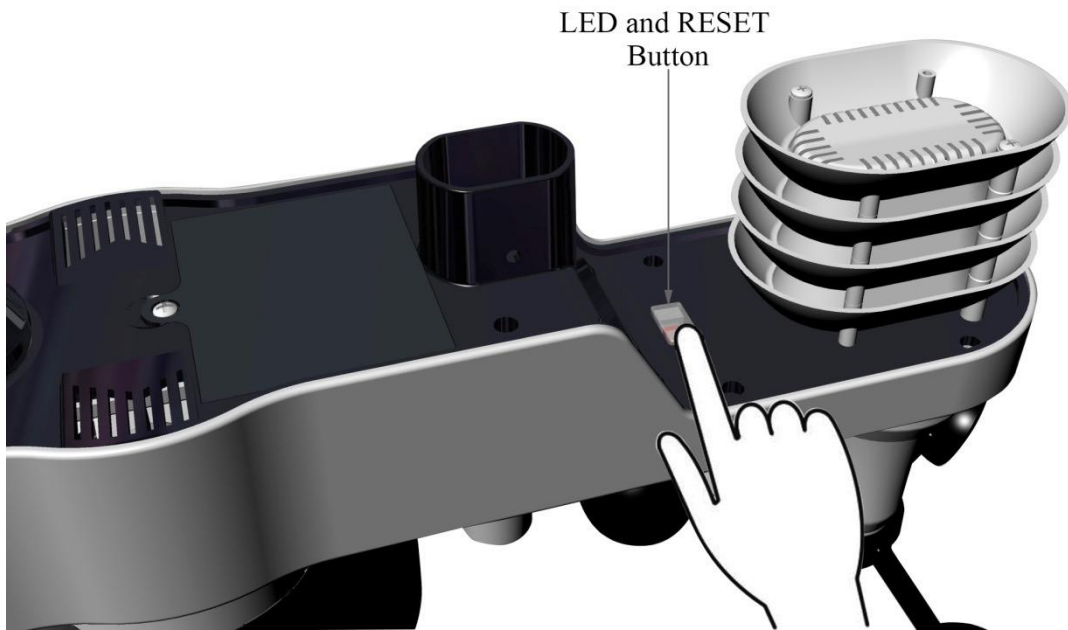

Figure 6

Setting up the thermo-hygrometer transmitter. Remove the battery door on the back of the sensor by removing the set screw, as shown in Figure 7.

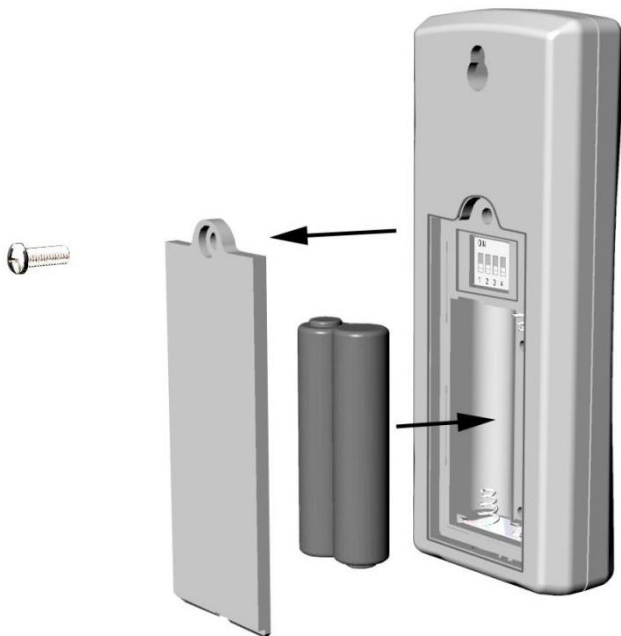

Figure 7

1. **BEFORE** inserting the batteries, locate the dip switches inside the battery compartment of the transmitter.
Figure 8 displays all four switches in the OFF position (factory default setting).

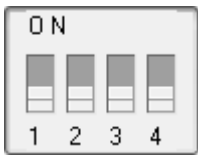

Figure 8

2. **Channel Number:** The DWS7100 supports up to eight transmitters. To set each channel number (the default is Channel 1), change Dip Switches 1, 2 and 3, as referenced in Table 1.
3. **Temperature Units of Measure:** To change the transmitter display units of measure (°F vs. °C), change Dip Switch 4, as referenced in Table 1.

DIP SWITCH				FUNCTION
1	2	3	4	
DOWN	DOWN	DOWN	---	Channel 1
DOWN	DOWN	UP	---	Channel 2
DOWN	UP	DOWN	---	Channel 3
DOWN	UP	UP	---	Channel 4
UP	DOWN	DOWN	---	Channel 5
UP	DOWN	UP	---	Channel 6
UP	UP	DOWN	---	Channel 7
UP	UP	UP	---	Channel 8
---	---	---	DOWN	°F
---	---	---	UP	°C

Table 1

4. Insert two AAA batteries.
5. After inserting the batteries, the remote sensor LED indicator will light for 4 seconds, and then flash once per 60 seconds thereafter. Each time it flashes, the sensor is transmitting data.
6. Verify the correct channel number (CH) and temperature units of measure (°F or °C) are on the display, as shown in Figure 9.

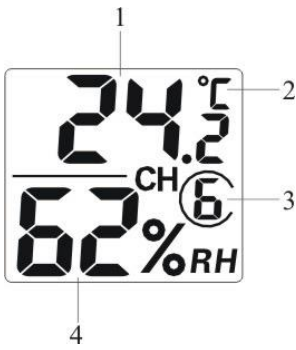

Figure 9

- (1) temperature
- (2) temperature units (°F vs. °C)
- (3) channel number
- (4) relative humidity

7. Close the battery door. Make sure the gasket (around the battery compartment) is properly seated prior to closing the door. Tighten the set screw.

3.4 Display Console

Display Console Layout

The display console layout is shown in Figure 10.

 **Note:** The following illustration shows the full LCD display for description purposes only; it will not appear like this during normal operation.



Figure 10

- | | |
|---|--|
| 1. Outdoor temperature display | 19. Outdoor temperature and humidity display |
| 2. Wi-Fi network | 20. Scroll mode indicator |
| 3. Outdoor humidity display | 21. Channel 1-8 indicator |
| 4. Outdoor humidity HI/LO alarm icon | 22. Pressure (relative and absolute) display |
| 5. Min/Max reset for 24h icon | 23. Pressure units of measure |
| 6. Rainfall display (rate, 24h, week, month, total) | 24. Wind speed average display |
| 7. Rainfall units of measure | 25. Wind gust display |
| 8. Indoor temperature and humidity HI/LO alarm icon | 26. Wind speed units of measure |
| 9. Indoor temperature and humidity display | 27. Wind chill and feels like HI/Lo alarm icon |
| 10. Time alarm icon | 28. Wind direction |
| 11. Time and date | 29. OUT dew point and AT (Apparent Temperature) display icon |
| 12. Humidity units of measure (%) | 30. Integrated outdoor transmitter Low power indicator |
| 13. UV Index display | 31. Temperature units (°F or °C) |
| 14. Sunshine intensity | 32. Outdoor temperature HI/LO alarm icon |
| 15. Moon phase | 33. Weather forecast |
| 16. Sunlight units of measure | |
| 17. Sensor Heat index display | |
| 18. Sensor Heat index (heat index; dew point) | |

Display Console Set Up

It is recommended to plug in the power supply to reduce the battery consumption and extend the service life.

 **Note:** The sensor array must be powered and updating before powering up the console, or the console will time-out searching for the sensors. Power up the console last.

Make certain the weather station sensor array is at least 3m away from the console and within 30m of the console. If the weather station is too close or too far away, it may not receive a proper signal. If you have more than one thermo-hygrometer transmitter, make sure they are all powered up and transmitting on different channels.

Remove the battery door on the back of the display, as shown in Figure 11. Insert three AAA (alkaline or lithium) batteries in the back of the display console. The display will beep once, and all of the LCD segments will light up for a few seconds to verify all segments are operating properly.

 **Note:** The character contrast is best from a slightly elevated viewing angle.

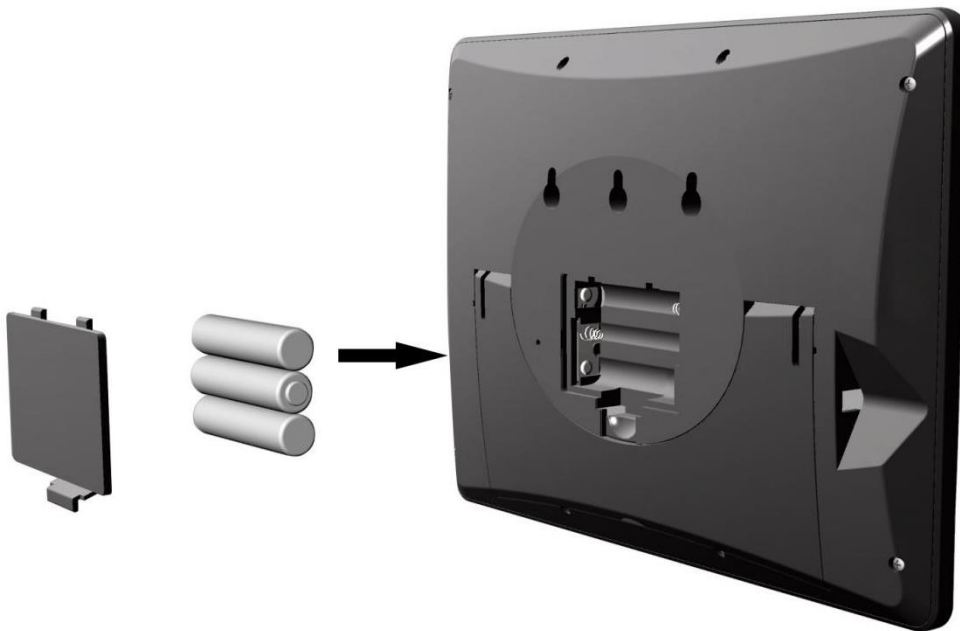

Figure 11

Replace the battery door, fold out the desk stand and place the console in the upright position.

The unit will instantly display indoor temperature, humidity, pressure, tendency, moon phase, and time. The wind speed, wind gust, wind direction, rain, UV/sunlight, thermo-hygrometer sensors, integrated outdoor temperature and humidity will update on the display within a few minutes.

Do not press any menu buttons until the data from the outside transmitter is displayed, otherwise the outdoor sensor search mode will be terminated. When the outdoor transmitter data has been received, the console will automatically switch to normal mode, from which all further settings can be performed.

While in the search mode, the remote search icon  will be constantly displayed.

If you have more than one thermo-hygrometer sensor (up to eight thermo-hygrometer sensors are supported), the display will automatically toggle between sensors until all sensors have reported in.

If it does not update, please reference the troubleshooting guide in Section 12.



 **Note:** The power adaptor is intended to be correctly oriented in a vertical or floor mounted position. The prongs are not designed to hold the plug in place if it is plugged into a ceiling, under-table or cabinet outlet.



Figure 12

 **Note:** If the power adaptor is plugged in, **BL ON** will display in the time area for three seconds when powered up. Conversely, if the power adaptor is not plugged in, **AC OFF** will be displayed, the icon  will display.

Sensor Operation Verification

The following steps verify proper operation of the sensors prior to installing the sensor array.

- 1. Verify proper operation of the rain gauge.** Tip the sensor array back and forth several times. You should hear a “clicking” sound within the rain gauge. Verify the rain reading on the display console is not reading 0.00. Each “click” represents 0.3mm of rainfall.
- 2. Verify proper operation of the wind speed sensor.** Rotate the wind cups manually or with a constant speed fan. Verify the wind speed is not reading 0.0.
- 3. Verify proper operation of the indoor and outdoor temperature sensors.** Verify the indoor and outdoor temperature readings match closely with the console and sensor array in the same location (about 3m apart). The sensors should be within 2°C (the accuracy is $\pm 1^\circ\text{C}$). Allow about 30 minutes for both sensors to stabilise.
- 4. Verify proper operation of the indoor and outdoor humidity sensors.** Verify the indoor and outdoor humidity readings match closely with the console and sensor array in the same location (about 3m apart). The sensors should be within 10% (the accuracy is $\pm 5\%$). Allow about 30 minutes for both sensors to stabilise.

4. Weather Station Installation

4.1 Pre-Installation

Before installing your weather station in its permanent location, we recommend operating the weather station for one week in a temporary location with easy access. This will allow you to check out all of the functions, ensure proper operation, and familiarise you with the weather station and calibration procedures. This will also allow you to test the wireless range of the weather station.

4.2 Site Survey

Perform a site survey before installing the weather station. Consider the following:

1. You will need to clean the rain gauge once per year and change the batteries every two years. Provide easy access to the weather station.
2. Avoid radiant heat transfer from buildings and structures. In general, install the sensor array at least 15cm from any building, structure, ground, or roof top.
3. Avoid wind and rain obstructions. The rule of thumb is to install the sensor array at least four times the distance of the height of the tallest obstruction. For example, if the building is 6m tall, install it $4 \times 6m = 24m$ away. Use common sense: if the weather station is installed next to a tall building, the wind and rain will not be accurate.
4. **Wireless Range.** The radio communication between receiver and transmitter in an open field can reach a distance of up to 100m, providing there are no interfering obstacles such as buildings, trees, vehicles, or high voltage lines. Wireless signals will not penetrate metal buildings. Most applications will only reach 30m due to building obstructions, walls and interference.
5. Radio interference from devices such as PCs, radios or TV sets can, in the worst case, entirely cut off radio communication. Please take this into consideration when choosing console or mounting locations.

4.3 Best Practices for Wireless Communication

Wireless communication is susceptible to interference, distance, walls and metal barriers. We recommend the following best practices for trouble free wireless communication.

1. **Electro-Magnetic Interference (EMI).** Keep the console several feet away from computer monitors and TVs.
2. **Radio Frequency Interference (RFI).** If you have other 433 MHz devices and communication is intermittent, try turning off these other devices for troubleshooting purposes. You may need to relocate the transmitters or receivers to avoid intermittent communication.
3. **Line of Sight Rating.** This device is rated at 100m line of sight (no interference, barriers or walls) but typically you will get 30m maximum under most real-world installations, which include passing through barriers or walls.
4. **Metal Barriers.** Radio frequency will not pass through metal barriers such as aluminium siding. If you have metal siding, align the remote and console through a window to get a clear line of sight.

The following is a table of reception loss vs. the transmission medium. Each "wall" or obstruction decreases the transmission range by the factor shown below.

Medium	RF Signal Strength Reduction
Glass (untreated)	5-15%
Plastics	10-15%

Wood	10-40%
Brick	10-40%
Concrete	40-80%
Metal	90-100%

4.4 Installation of Integrated Outdoor Transmitter

The DWS7100 can be used in both the Northern and Southern Hemispheres.

Prior to installation, you will need to calibrate the wind direction as shown below.

Northern Hemispheres (NOR)

The cardinal directions (N, S, E, W) moulded on the body of the outdoor sensor are indicators for the Northern Hemisphere only.

Step 1: There is an "S" indicator on the wind vane that indicates South, as shown in Figure 13. Align this "S" marker in the direction of South.

Step 2: Console operation is set to Northern Hemispheres (**NOR** in the time area) in Location division.

 **Note:** There are four letters of "N", "E", "S" and "W" around the wind direction, representing for the direction of North, East, South and West. The wind direction sensor has to be adjusted so that the directions on the sensor are matching with your real location. Permanent wind direction error will be introduced if the wind direction sensor is not positioned correctly during installation.



Northern Hemispheres

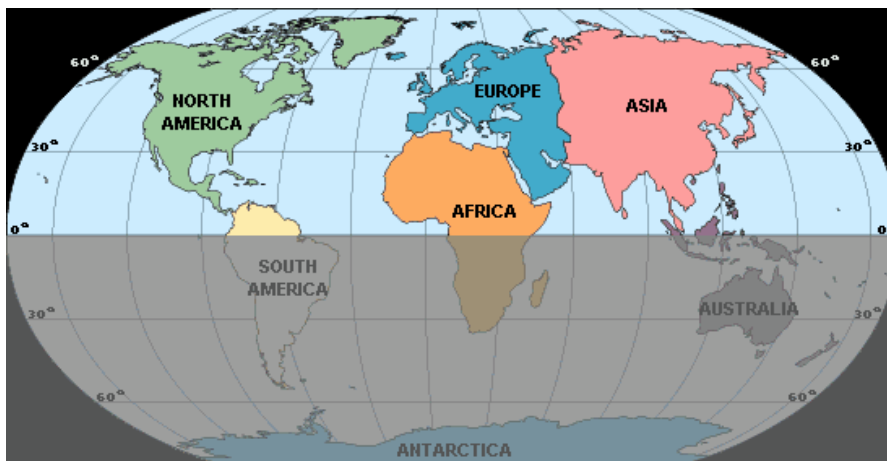

Southern Hemispheres

Figure 13

Southern Hemispheres (SOU)

For Southern Hemisphere installations, ignore these (N, S, E, W) and face **the solar panel to the North** (and in a sunny position) when it comes to installing the Integrated outdoor transmitter.

Step 1: Install the Integrated outdoor transmitter and face the solar panel North.

Step 2: Set the Console operation to Southern Hemispheres (**SOU** in the time area) in Location division.

 **Note:** Permanent wind direction error of approximately 180° will occur if the wind direction sensor is not positioned correctly during installation.

Fasten the integrated transmitter to mounting pole brackets, with two $\phi 3$ bolts and M3 nuts, as shown in Figure 14.



Figure 14

Attach the included mounting pole to your existing mounting pole with the four $\text{Ø} 5$ bolts and M5 nuts assembly, or fix on the wall with four tapping screws, as shown in Figure 15.

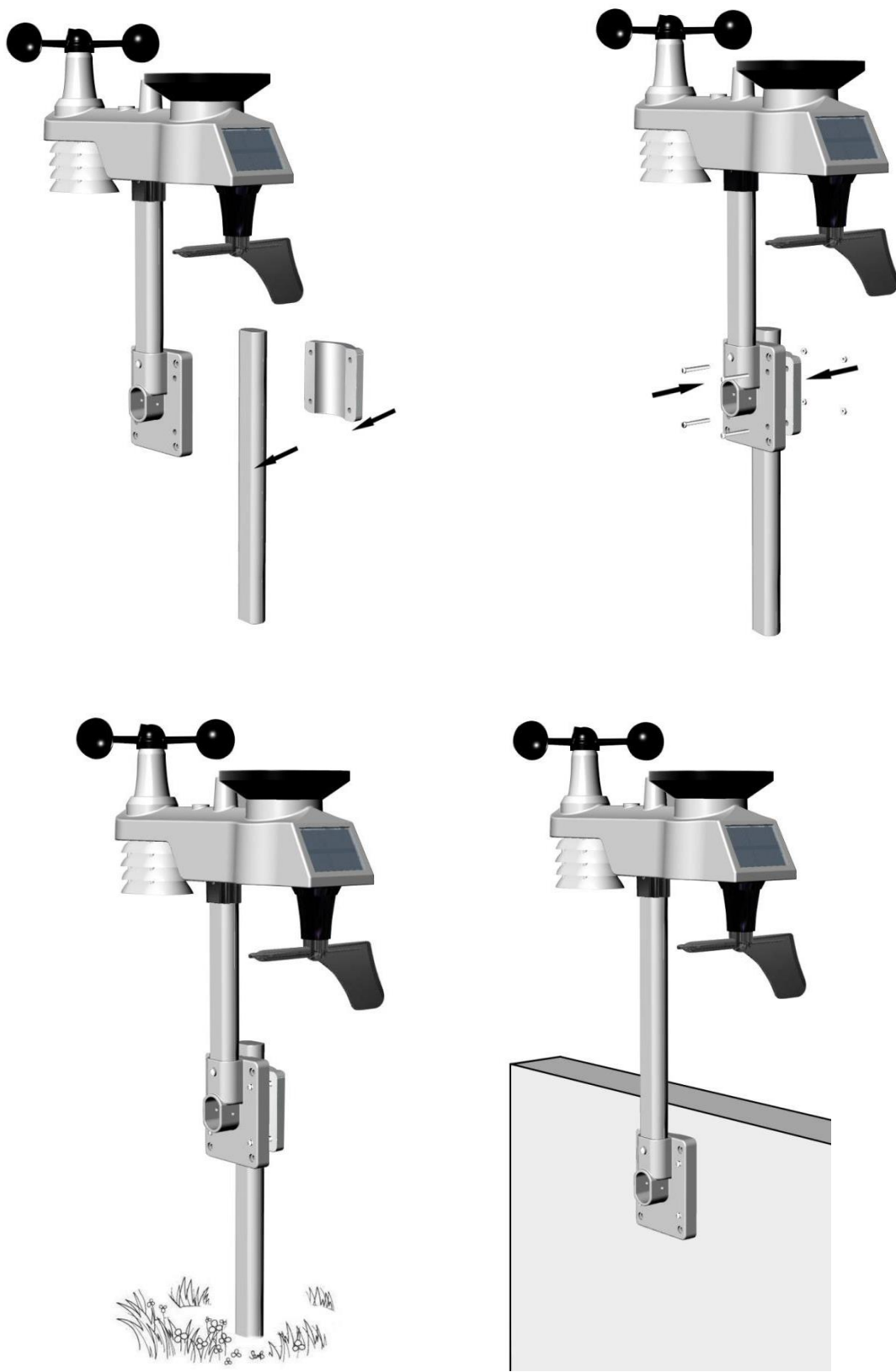

Figure 15

4.5 Remote Thermo-hygrometer Transmitter Installation

It is recommended you mount the Thermo-hygrometer sensor outside in a shaded area. A north-facing wall is preferred because it is in the shade most of the day. Direct sunlight and radiant heat sources will result in inaccurate temperature readings. Although the sensor is water-resistant, it is best to mount in a well-protected area, such as under an eave. Use a screw or nail (not included) to affix the remote sensor to the wall, as shown in Figure 16.

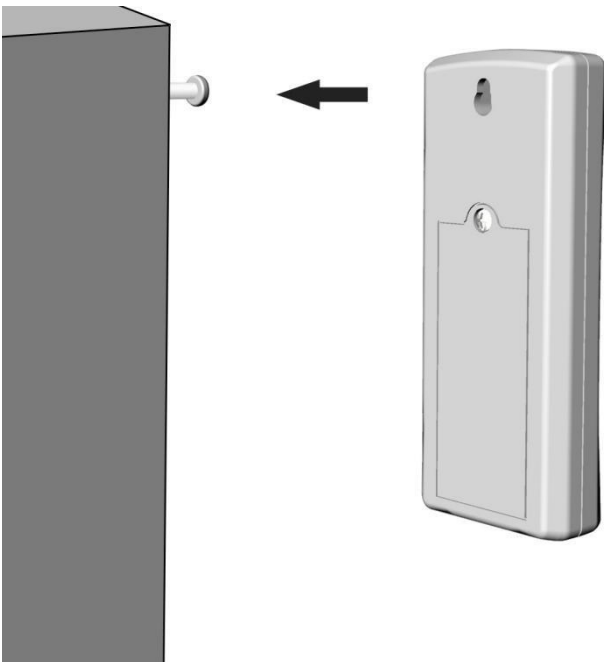



Figure 16

4.6 Low Battery Icons

A low battery indicator icon is shown in the display window for thermo-hygrometer sensor. When the low battery icon appears (the battery voltage is lower than 2.4V), replace the batteries in the sensor with fresh batteries. Never mix old and new batteries, and never mix battery types such as alkaline and lithium together.

A low battery indicator icon is shown in the display window of the Integrated outdoor transmitter. When the low battery icon appears (the battery voltage is lower than 3.6V), replace the batteries in the sensor with fresh batteries. Never mix old and new batteries, and never mix battery types such as alkaline and lithium together.

5. Display Console Operation

 **Note:** The console has five buttons for easy operation: **MIN/MAX/-**-button, **ALARM** button, **SET/MODE** button, **CHANNEL/+** and **SNOOZE** button.

5.1 Quick Display Mode

 **Note:** To exit the Quick Display Mode at any time, press the **SNOOZE** button of the display console.

While in Normal Mode, press (do not hold) the **SET/MODE** button to enter the Quick Display Mode as follows:

- Once for time, time/week and date
- Twice for indoor temperature, dew point
- Three for rainfall
- Four for outdoor dew point temperature
- Five for wind average
- Six for pressure
- Seven for sensor dew point

1. **Time, Time/Week and Date.** Press the **CHANNEL/+ or MIN/MAX/-** button to toggle between time, time/week and date.
2. **Indoor Temperature.** Press the **CHANNEL/+ or MIN/MAX/-** button to toggle between temperature and dew point.
3. **Rainfall.** Press the **CHANNEL/+ or MIN/MAX/-** button to toggle between rate, 24h, week, month and total. To clear the total rain, press the **CHANNEL/+ or MIN/MAX/-** button until total rain is displayed. The total rain will flash. Press and hold the **SET** button for five seconds until total rain reads 0.0.
4. **Outdoor Dew Point.** Press the **CHANNEL/+ or MIN/MAX/-** button to toggle between AT (Apparent Temperature) and dew point.
5. **Wind Average.** Press the **CHANNEL/+ or MIN/MAX/-** button to toggle between current, 2mins and 10 minutes.
6. **Absolute Pressure and Relative Pressure.** Press the **CHANNEL/+ or MIN/MAX/-** button to toggle between absolute pressure and relative pressure.
7. **Sensor Heat Index.** Press the **CHANNEL/+ or MIN/MAX/-** button to toggle between sensor heat index and dew point.

5.2 Set (Program) Mode

While in Normal Mode, press **and hold** the **SET(MODE)** button for at least three seconds to enter the Set Mode. The first setting will begin flashing. You can press the **SET(MODE)** button again to skip any step, as outlined below.



Note: In the Set mode, press the [+] button or [-] button to change or scroll the value. Hold the [+] button or [-] button for three seconds to increase/decrease rapidly.



Note: To exit the Set mode at any time, press the **SNOOZE** button of the display console.

1. **Time SYNC (default: ON).** Press the SET button again to set the network time sync. Press the [+] button or [-] button to switch between SYNC time ON and SYNC time OFF of measure.
2. **12/24 Hour Format (default: 24h).** Press the **SET(MODE)** button again to adjust the 12/24-hour format setting (FMT). Press the [+] button or [-] button to change between 12 hour and 24-hour format.
3. **Change Hour.** press the **SET(MODE)** button again to set the hour. Press the [+] button or [-] button to adjust the hour up or down. Note the PM icon is present during afternoon hours.
4. **Change Minute.** Press the **SET(MODE)** button again to set the minute. Press the [+] button or [-] button to adjust the minute up or down.
5. **Date Format (default: MM-DD):** Press the **SET(MODE)** button again to enter the day/month format mode. Press the [+] button to switch between MM-DD-YY, DD-MM-YY.
6. **Change Month.** Press the **SET(MODE)** button again to set the calendar month. Press the [+] button or [-] button to adjust the calendar month.
7. **Change Day.** Press the **SET(MODE)** button again to set the calendar day. Press the [+] button or [-] button to adjust the calendar day.

8. **Change Year.** Press the **SET(MODE)** button again to set the calendar year. Press the [+] button or [-] button to adjust the calendar year.
9. **Max/Min Clearing (default: ON).** Press the **SET(MODE)** button again to set the max/min clearing mode (CLR). The Max/Min can be programmed to clear daily (at midnight) or manually. Press the [+] button or [-] button to switch between "Clears 24h" and Clears Manually.
10. **Temperature Units of Measure (default: °C):** Press the **SET(MODE)** button again to change the temperature units of measure (the **UNITSET** icon will be displayed). Press the [+] button or [-] button to switch between °F and °C units of measure.
11. **Wind Speed Units of Measure (default: m/s).** Press the **SET(MODE)** button again to change the wind speed units of measure. Press the [+] button or [-] button to toggle the wind speed units between m/s, km/h, mph, knots or bft.
12. **Rainfall Units of Measure (default: mm).** Press the **SET(MODE)** button again to change the Rainfall units of measure. Press [+] button or [-] button to toggle the rainfall units between mm and inch.
13. **Barometric Pressure Display Units (default: hPa).** Press the **SET(MODE)** button again to change the pressure units of measure. Press the [+] button or [-] button to toggle the pressure units between mmHg, inHg or hPa.
14. **Pressure Threshold Setting (default level 2).** Press the **SET(MODE)** button again to change the pressure threshold. Press the [+] button or [-] button to change pressure threshold 2 mbar/hour to 4 mbar/hour. (For detailed information, refer to 'Pressure Threshold Setting' in section 9)
15. **Weather Icons Setting (default: partly cloudy).** Press the **SET(MODE)** button again to change the initial weather icon. Press the [+] button or [-] button to select the initial weather icon of Sunny, Cloudy, Partly Cloudy or Rainy. (For detailed information of this part please refer to 'Weather Icons' in section 9).
16. **Sunlight Display Units (default: W/m²).** Press the **SET(MODE)** button again to change the sunlight units of measure. Press the [+] button or [-] button to toggle the sunlight units between, W/m², fc or lux.
17. **Location division. (default: Northern Hemisphere).** Press the **SET(MODE)** button again to change the location division. Press the [+] button or [-] button to toggle the sunlight units Northern Hemisphere (NOR) or Southern Hemisphere (SOU). (refer to 'Installation of Integrated Outdoor Transmitter' in section 4).

5.3 Chanel Selection

Press the **CHANNEL/+** button to switch the display between remote thermo-hygrometer sensors 1 through 8 and scroll mode . In scroll mode, all of the detected thermo-hygrometer sensors will be displayed in five second intervals.

5.4 Sensor Search Mode

If a sensor loses communication, dashes (-.-) will be displayed. If a specific channel is lost, press the **CH/+** button to display that channel prior to entering the search mode.

To reacquire the lost signal, press and hold the **CH/+** button for 3 seconds to enter the sensor search mode.

The icon **AIO** will appear in the time area. You can synchronise one or all of individual sensors. Press the [+] or [-] button to toggle between the following sensors:

- **AIO.** Synchronises the Integrated outdoor transmitter.
- **CH*.** Synchronises Channel 1-8 Sensors (dependent on which channel is displayed before entering the Sensor Search Mode).
- **ALL.** Synchronises All Sensors.
- **NOT.** Do nothing and exit the Sensor Search Mode.

After selecting one of the above options, press the **SET(MODE)** button to resync, and the display will return to normal mode. **Do not press any buttons** until the synchronisation is complete. The remote search icon will display constantly for 3 minutes until the signal is reacquired.

5.5 Reset Min/Max record

 **Note:** If you have more than one thermo-hygrometer sensor, the minimum and maximum value of all channels will be cleared in the reset mode.

In normal mode, press (do not hold) the **MIN/MAX/-** button, the **MAX** icon will be displayed in date area. Press the **SET/MODE** button to view max values of rainfall (rate, 24h, week or month), pressure (ABS or REL), outdoor temperature and humidity (AT or dew point), indoor temperature and humidity (temp or dew point) and sensor temperature and humidity, sensor dew point or heat index.

Press the **MIN/MAX/-** button for three seconds to clear all max values (the rainfall, wind speed, wind gust, pressure, temperature and humidity maximum values). The maximum values will now display the current values.

Press the **CHANNEL/+** button to switch the display between remote thermo-hygrometer sensors 1 through 8 to view Max values.

Press the **MIN/MAX/-** button again (do not hold), the **MIN** icon will be displayed. Press the **SET/MODE** button to view min values of pressure (absolute or relative), outdoor temperature/humidity (AT or dew point), indoor temperature/humidity (temp or dew point), sensor temperature humidity, sensor dew point (dew point or heat index).

Press the **MIN/MAX/-** button for three seconds to clear all min values. (the pressure, temperature and humidity minimum values. The minimum values will now display the current values).

Press the **CHANNEL/+** button to switch the display between remote thermo-hygrometer sensors 1 through 8 to view Min values.

Press the **SNOOZE** button to exit the min/max checking and clearing mode, return to normal display mode.

5.6 Snooze Mode

If the alarm sounds, and you wish to silence the alarm, press the **SNOOZE** button, the backlight will turn on. The alarm icon will continue to flash and the alarm will silence for five minutes. press any button (**MIN/MAX/+, SET/MODE, ALARM, CHANNEL/+**) to permanently exit the **Snooze** mode.

5.7 Backlight Mode

If the LED is off, Press the **SNOOZE** button once. The backlight will turn on for five seconds, and if no operation is performed for three seconds, the backlight will turn off.

To save power, the backlight operation is different when operating on batteries.

ADJUSTABLE BACKLIGHT BRIGHTNESS

There are 3 levels of brightness of backlight. When the backlight is on, press SNOOZE button to switch between the 3 levels.

When the backlight is off, press and hold the **SNOOZE** button for two seconds, the backlight will turn on permanently, and **BL ON** icon will be displayed for three seconds in the date area.

To turn off the backlight at any time press and hold the **SNOOZE** button for two seconds. **BL OFF** icon will be displayed for three seconds in the date field.

 **Note:** If plugged into AC power, the time area will display "AC ON" and the backlight will remain on. It is not recommended leaving the backlight on for a long period of time when operating on batteries only, or the batteries will run down quickly.

5.8 Alarm Mode

The DWS7100 includes the following alarms:

- Time (There are two alarms for time: Alarm 1 and Alarm 2)
- Outdoor Temperature
- Outdoor Humidity
- Outdoor AT (Apparent Temperature)
- Outdoor Dew Point
- Outdoor Feels Like Temperature
- Outdoor Dew Point
- Wind Gust
- Wind Average
- Rate Rainfall
- 24 Hour Rainfall
- Absolute Pressure
- Relative Pressure
- Indoor Temperature
- Indoor Humidity
- Indoor Dew Point
- UV Index
- Sunlight
- Sensor (CH1) Temperature
- Sensor (CH1) Humidity
- Sensor (CH1) Heat Index
- Sensor (CH1) Dew Point

Alarm Operation

When an alarm condition is exceeded, the alarm icon will flash  (visual) and the alarm beeper will sound (audible). To silence the beeper, press any button.

Viewing the High and Low Alarms

To view the current alarm settings, press the **ALARM** button to enter the alarm mode. HI AL 1 will be displayed in the date area. At the same time Alarm 1 time and HI alarm parameters of indoor temperature/humidity, outdoor temperature/humidity, rain rate, AT, feels like, wind gust, wind average, absolute pressure, UV index, Sunlight, Sensor (CH1) temperature/humidity and dew point are displayed. Press **SET/MODE** button to view Alarm 2 time and HI alarm parameters of indoor dew point, 24h rainfall, outdoor dew point, relative pressure and Sensor (CH1) heat index.

Press **ALARM** button again to view the LOW alarms along with the alarm clock time in the same way as with the HI alarms.

Press the **SNOOZE** button at any time to return to the normal mode.

Setting the Alarms

Press **ALARM** button to enter the alarm mode.

Press and hold the **SET/MODE** button for three seconds. The first alarm parameter will begin flashing (alarm hour).

To save the alarm setting and proceed to the next alarm parameter, Press (do not hold) the **SET/MODE** button.

To adjust the alarm parameter, press the [+] or [-] button to increase or decrease the alarm settings, or press and hold the [+] or [-] button for three seconds to increase or decrease the alarm settings rapidly.

Press the **ALARM** button (the alarm icon will appear) to turn the alarm on and off.

Press the **SNOOZE** button once at any time to return to the normal mode. After 30 seconds of inactivity, the alarm mode will time out and return to normal mode.

The following is a list of the individual alarm parameters that are set (in order):

1. Alarm hour (alarm 1)
2. Alarm minute (alarm 1)
3. Alarm hour (alarm 2)
4. Alarm minute (alarm 2)
5. Outdoor temperature high alarm
6. Outdoor temperature low alarm
7. Outdoor humidity high alarm
8. Outdoor humidity low alarm
9. Outdoor AT high alarm
10. Outdoor AT low alarm
11. Outdoor dew point high alarm
12. Outdoor dew point low alarm
13. Outdoor feels like high alarm
14. Outdoor feels like low alarm
15. Wind Gust high alarm
16. Wind Average high alarm
17. Rainfall (RATE) high alarm
18. Rainfall (24h) high alarm
19. Absolute pressure high alarm
20. Absolute pressure low alarm
21. Relative pressure high alarm
22. Relative pressure low alarm
23. Indoor temperature high alarm
24. Indoor temperature low alarm
25. Indoor humidity high alarm
26. Indoor humidity low alarm
27. Indoor dew point high alarm
28. Indoor dew point low alarm
29. UV Index high alarm

30. Sunlight high alarm
31. Sensor (CH1) Temperature high alarm
32. Sensor (CH1) Temperature low alarm
33. Sensor (CH1) Humidity high alarm
34. Sensor (CH1) Humidity low alarm
35. Sensor (CH1) Heat Index high alarm
36. Sensor (CH1) Heat Index low alarm
37. Sensor (CH1) Dew Point high alarm
38. Sensor (CH1) Dew Point low alarm

 **Note:** To prevent repetitive temperature alarming, there is a 0.5 °C tolerance band. For example, if you set the high alarm to 26.7 °C and silence the alarm, the alarm icon will continue to flash until the temperature falls below 26.2°C, at which point, the alarm will reset and must increase above 26.7 °C to activate again.

 **Note:** To prevent repetitive alarming of humidity, there is a 4% tolerance band in humidity alarm. For example, if you set the high alarm to 60% and silence the alarm, the alarm icon will continue to flash until the humidity falls below 56%, at which point, the alarm will reset and must increase above 60% to activate again.

Alarm and Command Button Beeper ON/OFF Mode

The beeper can be silenced for both alarms and button presses.

In normal mode, press and hold the **ALARM** button for three seconds to toggle the beeper on or off (depending on the current setting).

The **BZON** (beeper on) or **BZOFF** (beeper off) icon will appear in the time area for three seconds. press and hold the **ALARM** button again for three seconds to toggle the **BZON** or **BZOFF** command.

Wi-Fi Connection Status

When the console successfully connects to your Wi-Fi router, the Wi-Fi signal icon  will appear on the LCD display (to the left of Indoor Temperature). If the Wi-Fi signal is not stable or the console is trying to connect to the router, the icon will flash. If the icon disappears, it means the console is not connected to the Wi-Fi router.

 **Note:** If you own a dual band router (2.4 GHz and 5.0 GHz), make sure you connect to the 2.4 GHz band, otherwise it will fail to connect the weather station to Wi-Fi.

5.9. Time Server Sync Status

After the console has connected to the internet, it will attempt to connect to the internet time server to obtain the time. Once the connection succeeds and the console's time has updated, the SYNC icon **SYNC** will appear on the LCD. The time will automatically synchronise to the internet each hour.

 **Note:** Time synchronisation method: Synchronised through internet UTC time server.

6. Registration with Weather Server Websites

6.1 Register with WeatherCloud.net

Note: This is best done on a desktop computer or laptop.

Visit <https://weathercloud.net/> and enter a username, email address and password (**This is your Login password for the website, not your email account password. So, no private information will be exposed.**).

Sign Up

1) Click Sign up as below

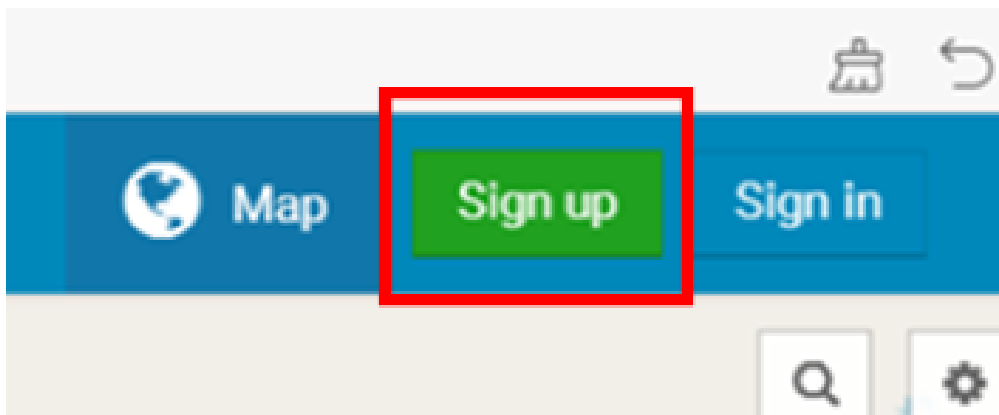

Figure 17

2) As shown below, enter a username, email address and create a password, then Click Sign up.

A screenshot of the WeatherCloud.net registration form. At the top left is the WeatherCloud logo. The main heading is 'Join Weathercloud'. Below the heading are three input fields: a username field containing 'uct5', an email field containing '*****@qq.com', and a password field containing '*****'. A blue 'Sign up' button is positioned below the input fields. At the bottom of the form, there is a small text link: 'By clicking Sign up, you agree to our Terms of Service and Privacy Policy.'

Figure 18

3) As shown below, an email will be received in your registered mailbox.

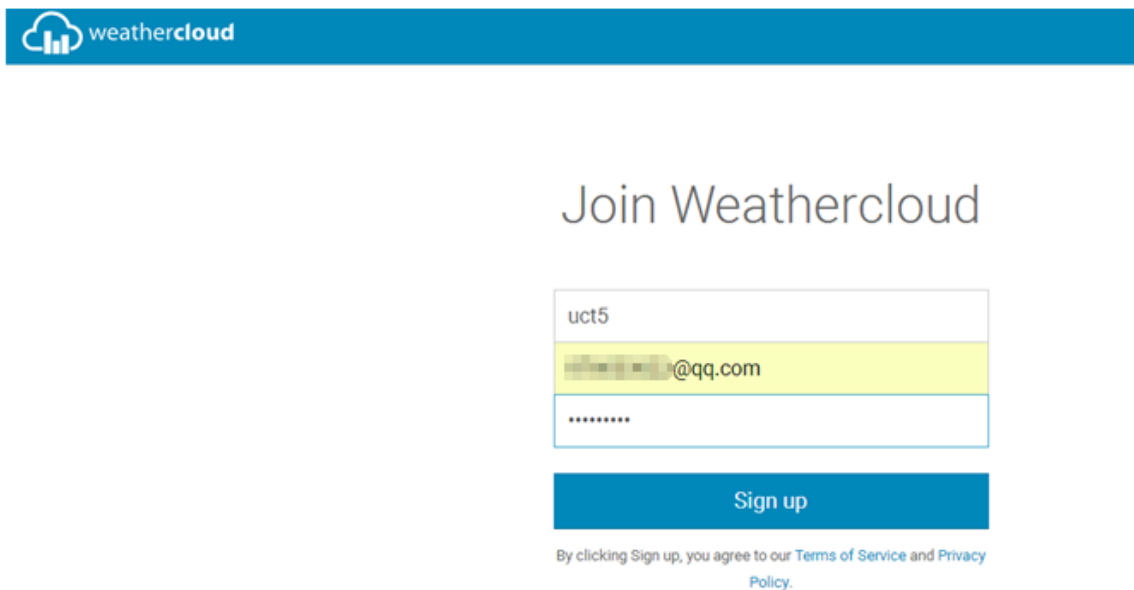
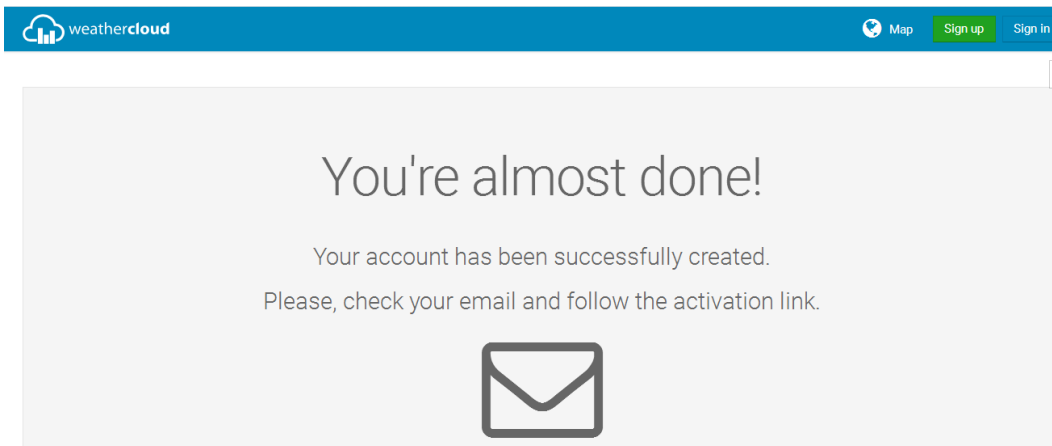

Figure 19

4) As shown below, go to your email inbox and log in to the web address in the email you will have received.

Hello [redacted]

Thanks for registering and welcome to Weathercloud!

To activate your new account please click on the link below or copy and paste the URL into your browser:

<https://app.weathercloud.net/page/activate/key/Lyfkalj48ZJwAvPMzys7X0F3a5RuXwF7LG4xhhu6Hh6LvhzNgKI2i1aYUjmNm1lv>

Figure 20

5) As shown below, click “here” to enter the homepage of the Weathercloud website.

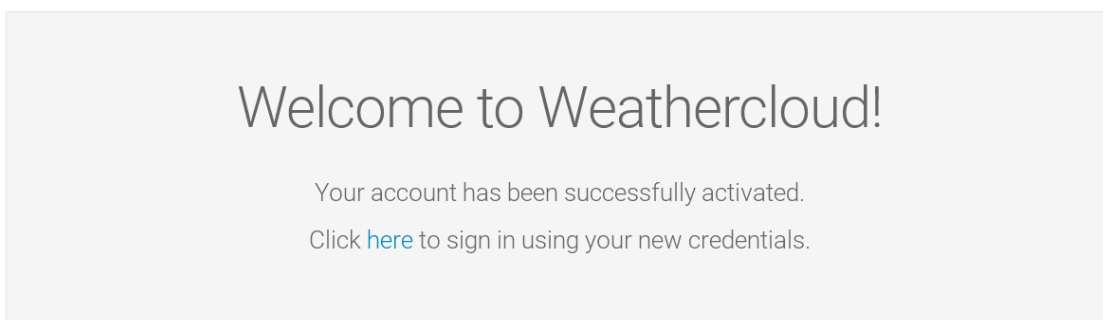

Weathercloud uses cookies and similar technologies to customize the content we provide and to analyze the navigation in order to offer you a better, faster and safer experience. To use Weathercloud, you must agree to the use we make of these technologies. [Read more.](#)

I agree

Figure 21

6) As shown below, enter the email address and password you just registered to enter the Weathercloud website.

Sign in

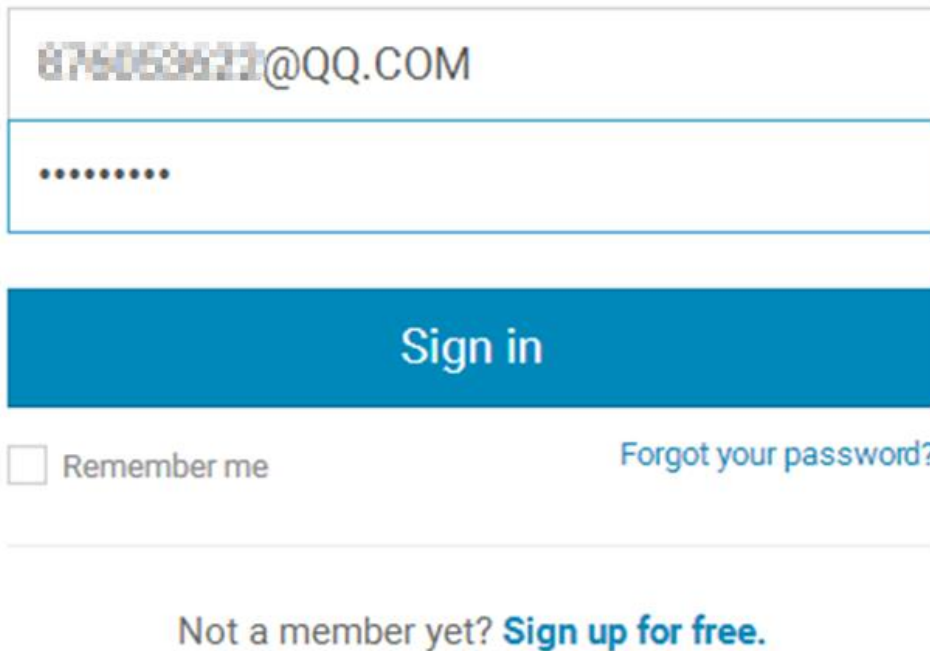

The sign-in form consists of two input fields stacked vertically. The top field contains the email address "81760653927@QQ.COM". The bottom field contains a series of ten dots representing a password. Below the fields is a large blue button with the text "Sign in". Underneath the button, there is a checkbox labeled "Remember me" and a link that says "Forgot your password?". A horizontal line separates this section from the text "Not a member yet? Sign up for free." below it.

Figure 22

Add a weather station device (it may take a few minutes).

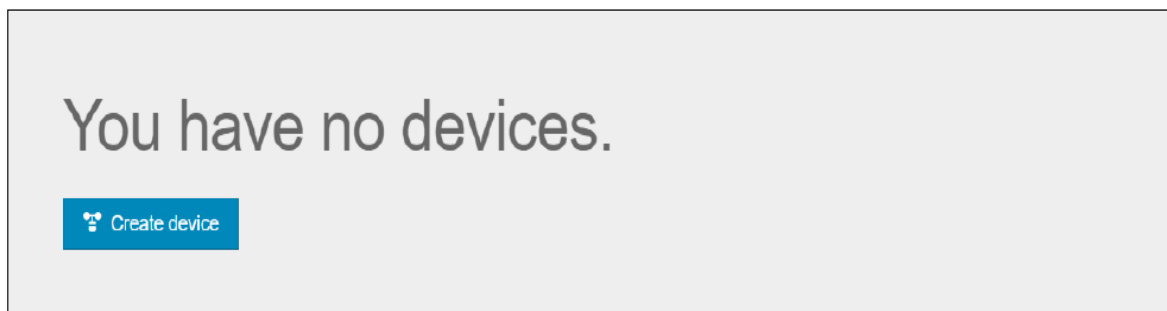

The screen displays the text "You have no devices." in a large, grey font. Below this text is a blue button with a white plus sign icon and the text "Create device".

Figure 23

1) After signing up you will be prompted to add a device/ Select "Create device" and enter your station's information:

Boxes with red * must be filled in.

Name *	<input type="text" value="FT0300"/>	Country *	<input type="text" value="Hong Kong"/>
Model *	<input type="text" value="Ultimeter 100 Series"/>	State / Province *	<input type="text" value="Hong Kong"/>
Link type *	<input type="text" value="Weather Display"/>	City *	<input type="text" value="Hong Kong"/>
Website	<input type="text" value="www.example.com"/>	Time zone *	<input type="text" value="(UTC+08:00) Hong Kong"/>
Description	<input type="text"/>		

Latitude *

Longitude *

Elevation m

Figure 24

Note: You can select any Model number and Link type in the above boxes.

2) As shown below, click Get coordinates to identify your location of on the map, then click Done to confirm.

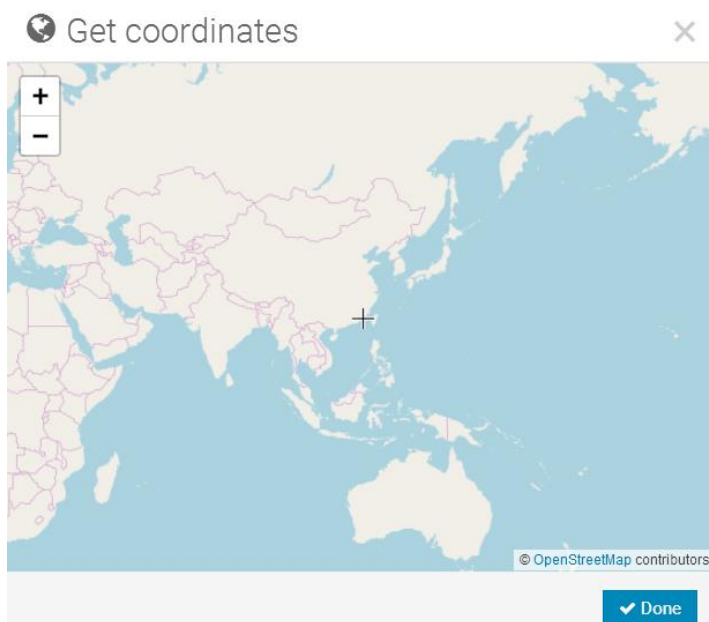

Figure 25

3) As shown below, click Create.

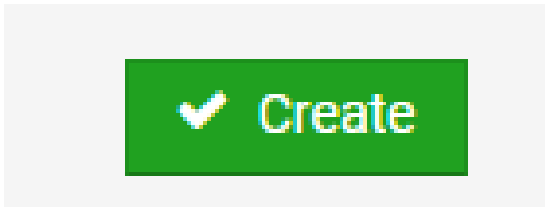

Figure 26

4) As shown below, after registering successfully, please record the Weathercloud ID and Key information for later use.

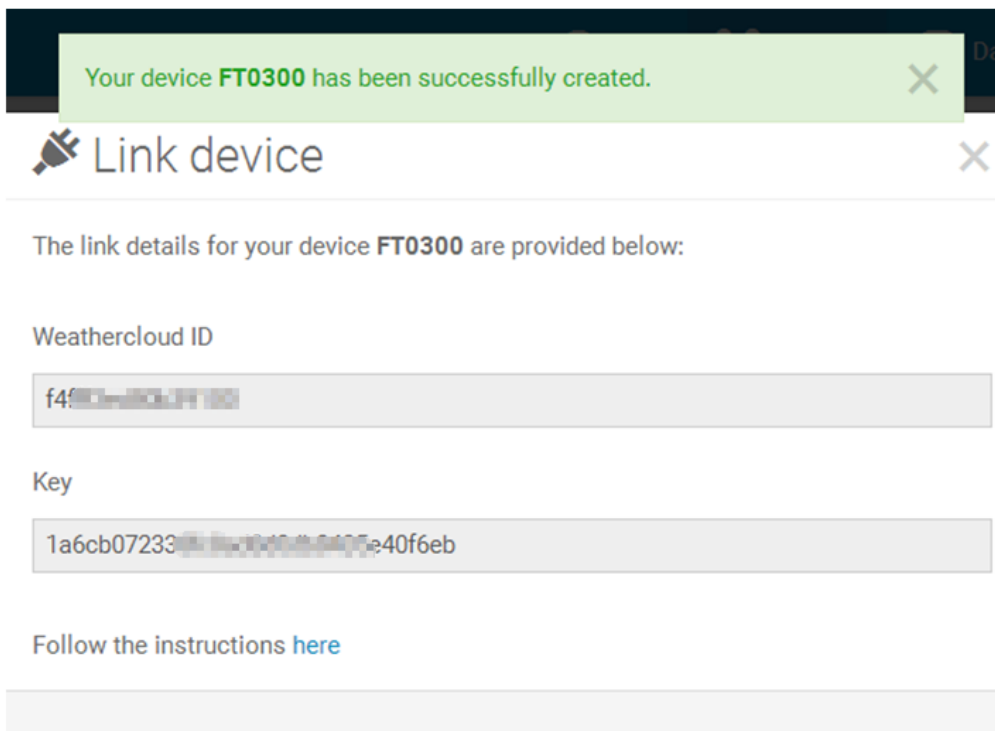

Figure 27

6.2 Register with Wunderground.com (Weather Underground)

 **Note:** The Weather Underground website is subject to change.

Visit: <https://Wunderground.com>, and select the 'Join' link in the upper right and corner and create a Free Account.

1) As shown below, click 'Join'.

WEATHER UNDERGROUND | Sensor Network | Maps & Radar | Severe Weather | News & Blogs | Mobile Apps | More

Search Locations | Log in | I...

Popular Cities: San Francisco, CA 66 ° F Clear | Manhattan, NY 49 ° F Clear | Schiller Park, IL 49 ° F Cloudy | Boston, MA 50 ° F Clear | Houston, TX 58 ° F Clear | London, England, United Kingdom 47 ° F Fair

Member Account

Join Weather Underground

- Choose real-time alerts for your city.
- Choose adding your webcam or personal weather station.
- You can delete your account at any time from your member settings.

The Weather Company needs your email to create your Weather Underground account.

Email

Password (5-30 characters) [Show](#)

Confirm New Password:

I agree to the [Terms of Use](#)

Figure 28

2) As shown below, enter a username, email address and a password **(this is your Login password for the website, not your email password. So, no private information will be exposed)**. Click 'Sign up for free'.

Join Weather Underground

- Choose real-time alerts for your city.
- Choose adding your webcam or personal weather station.
- You can delete your account at any time from your member settings.

The Weather Company needs your email to create your Weather Underground account.

Email
 ✓

Password (5-30 characters) [Show](#)
 ✓

Confirm New Password:

I agree to the [Terms of Use](#)

[Sign up for free](#)

[Already have an account? Sign in](#)

Figure 29

3) As shown below, registration has been successfully completed.

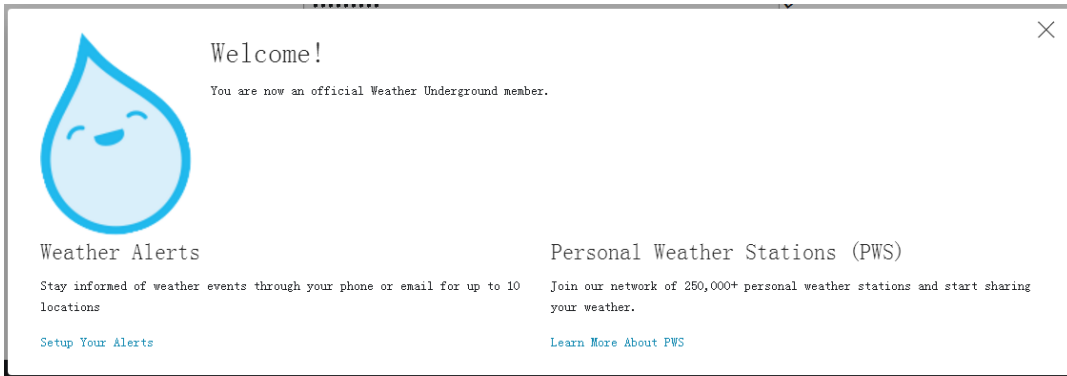

Figure 30

4) As shown below, click Log in and enter the email address and password you just registered.

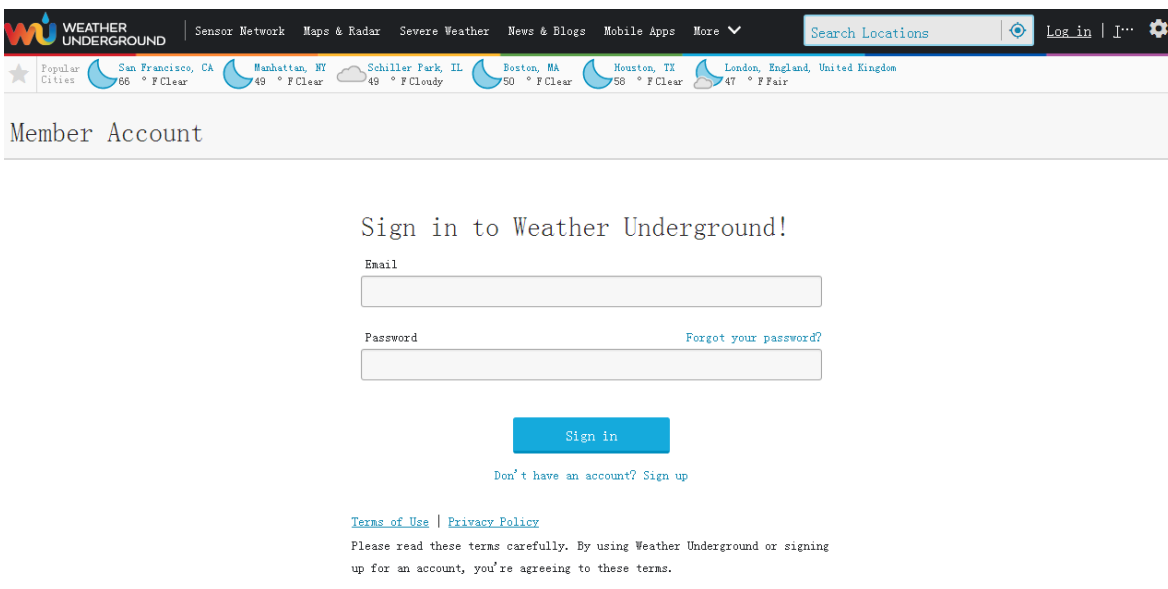

Figure 31

5) As shown below, click 'My Profile'. Then enter Member Settings.

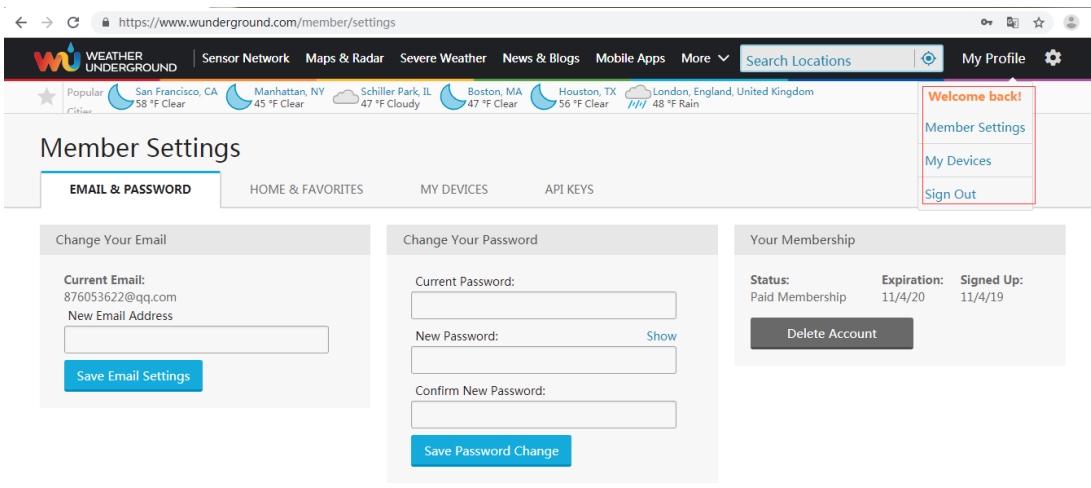

Figure 32

6) As shown below, click 'Update home location'.

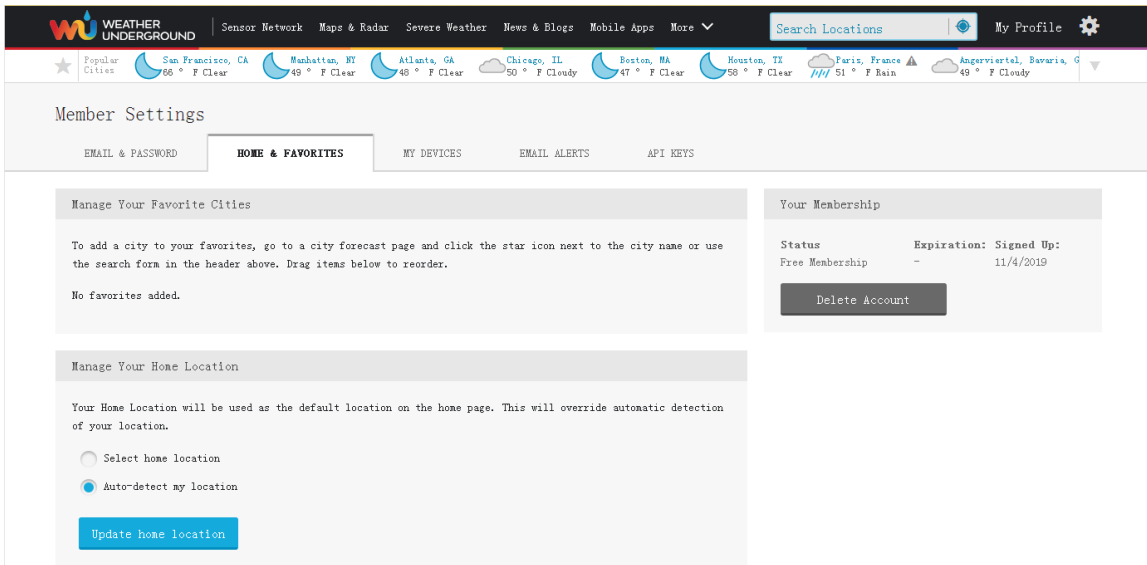

Figure 33

7) As shown below, you will then be prompted to add a device/ Select 'Add New Device'

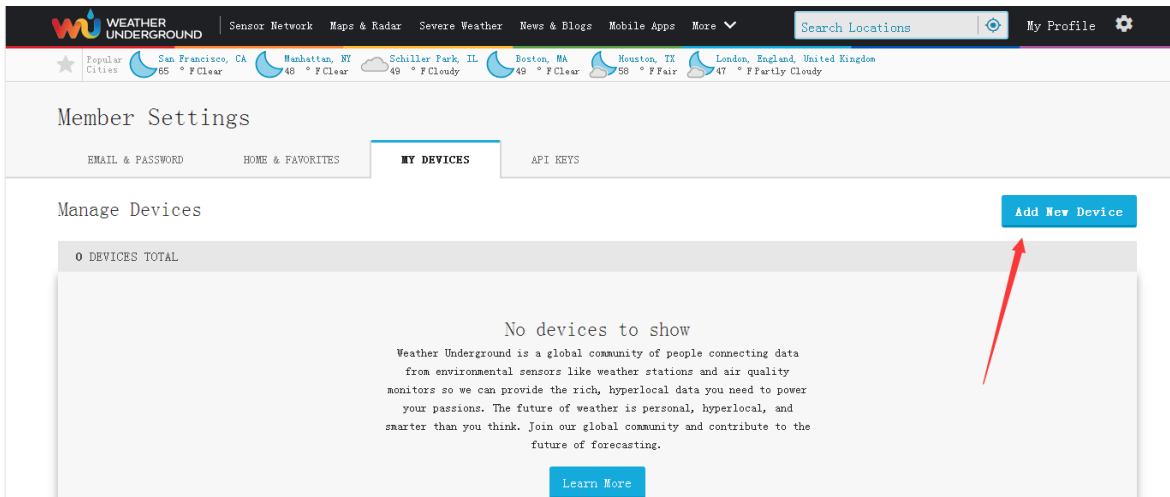

Figure 34

8) As shown below, click 'Personal Weather Station'.

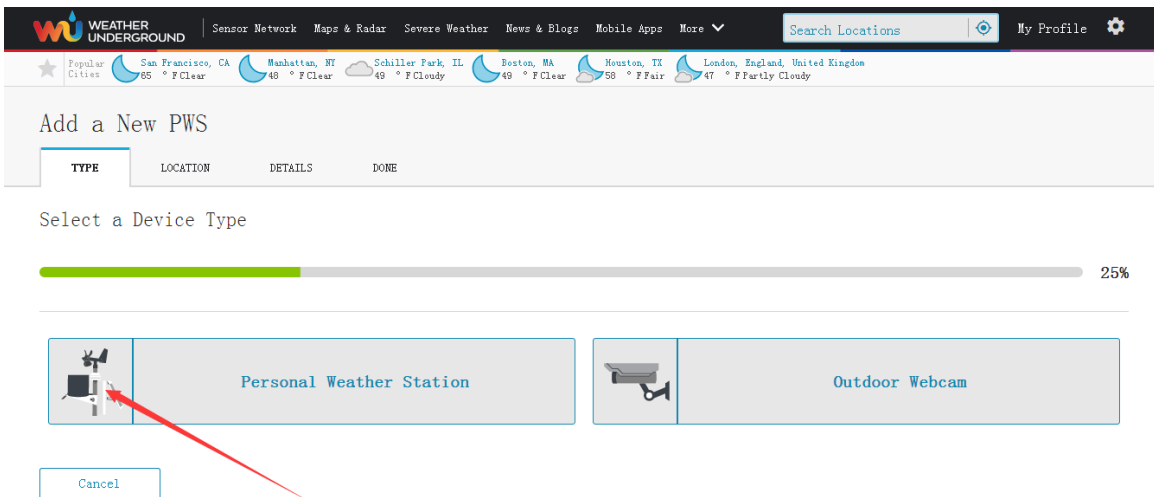
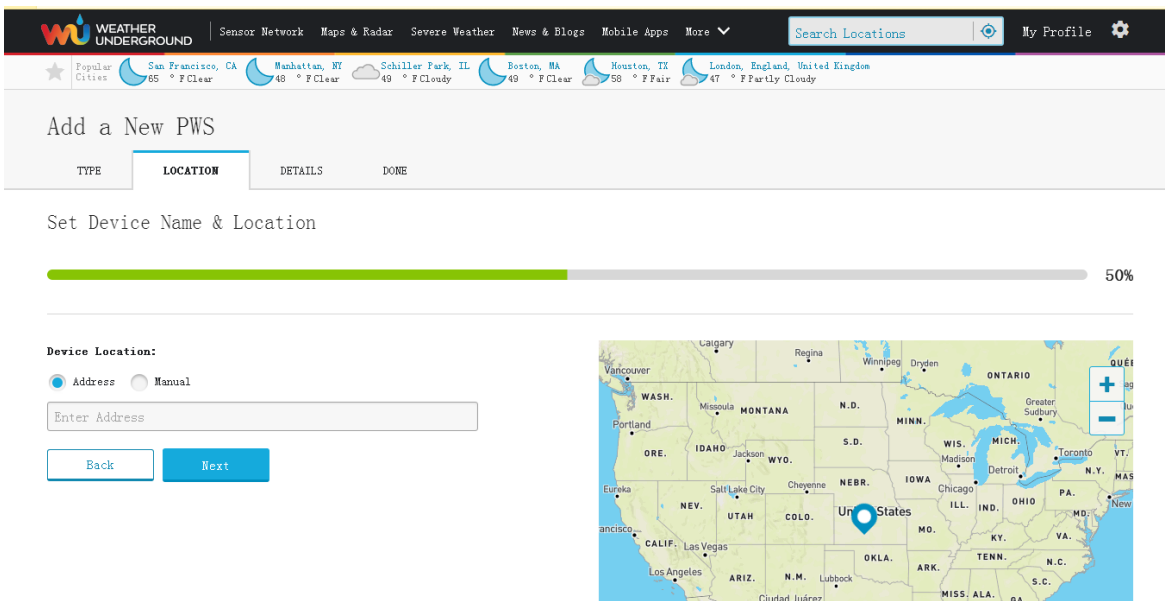

Figure 35

9) As shown below, select Address by inputting an address or select Manual to position your address automatically. Then click Next:



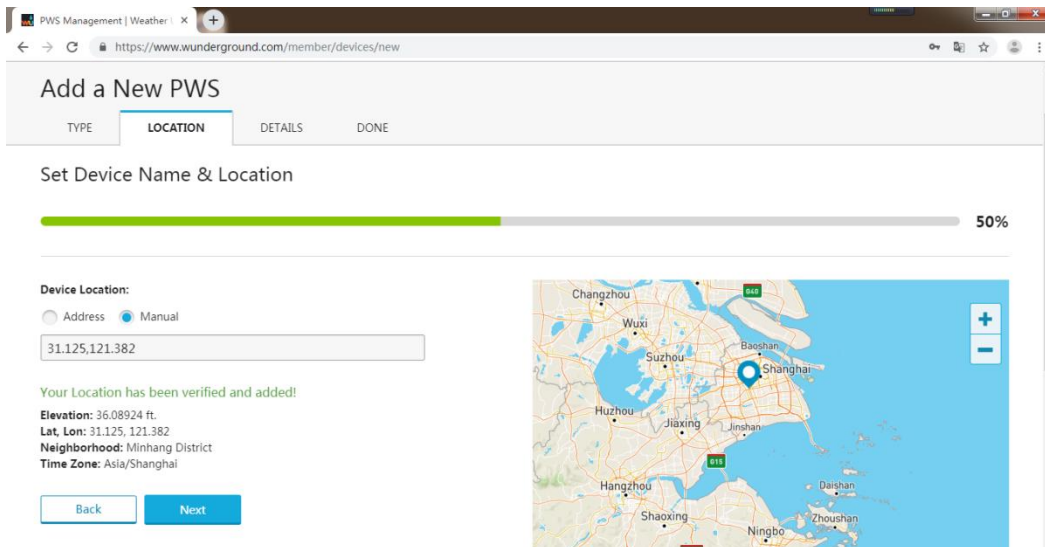

Figure 36

10) As shown below, you will then be prompted to add more information about your device. Complete the appropriate information then click 'I Accept' and 'Next':

Boxes with red (Required) must be filled in.

Note: You can select any Wi-Fi weather station model in the Device Hardware box; we recommend 'AcuRite 5-in-1 Weather Station with Wi-Fi'.

Name: (Required)

Surface Type:

Elevation: (Required)

Associate Webcam:

Device Hardware: (Required)

 Select device hardware
 Airmar 150wx Ultrasonic
 Airmar 200wx Ultrasonic
 AcuRite 3-in-1 Weather Station with Wi-Fi
 AcuRite 5-in-1 Weather Station with Wi-Fi
 AcuRite 5-in-1 Weather Station with AcuRite Access
 AcuRite Atlas Weather Station with AcuRite Access
 AcuRite Basic Weather Station with Wi-Fi
 AcuRite Basic Weather Station with AcuRite Access
 AcuRite Pro Weather Center
 Ambient Weather WS-0262A
 Ambient Weather WS-0265
 Ambient Weather WS-1000 (Wireless)
 Ambient Weather WS-1001-WiFi (Wireless)
 Ambient Weather WS-1002-WiFi (Wireless)
 Ambient Weather WS-1200-IP (Wireless)
 Ambient Weather WS-1400-IP (Wireless)
 Ambient Weather WS-2000
 Ambient Weather WS-2090 (Wireless)
 Ambient Weather WS-2902

self and your sensor. We use this information to manage your account and to improve the commercial purposes, such as your sensor location.

Height Above Ground:

Ft. Above Ground

You Make Our Forecasts More Accurate, We Respect Your Privacy

Contribute to the Weather Underground community by sharing some information about yourself and your sensor. We use this information to manage your account and to improve the experience from the Weather Underground community. We may also share certain data for commercial purposes, such as your sensor location.

[Learn more about how we take your privacy seriously](#)

(Required)

I Accept I Deny

Email Preferences:

I would like to receive PWS notifications.

Back

Next

Figure 37

11) As shown below, after registering the host successfully, please record Station ID and Station Key information for use later. These details will be needed when you configure your console for Wi-Fi access.

Registration Complete!

100%

Congratulations! Your personal weather station is now registered with Weather Underground.

Enter the information below to your weather station software.

Your PWS

Station ID: ISHANG26

Station Key: ondw70oa



Configure Your Software

View Devices

Figure 38

12) As shown below, registration is done successfully.

WEATHER UNDERGROUND Sensor Network Maps & Radar Severe Weather News & Blogs Mobile Apps More

Search Locations My Profile

★ Popul City 65 ° F Clear San Francisco, CA 48 ° F Clear Manhattan, NY 49 ° F Cloudy Schiller Park, IL 49 ° F Clear Boston, MA 49 ° F Clear Houston, TX 58 ° F Fair London, England, United Kingdom 47 ° F Partly Cloudy

Member Settings

EMAIL & PASSWORD HOME & FAVORITES **MY DEVICES** API KEYS

Manage Devices

Add New Device

1 DEVICES TOTAL

Name	Location	Status	ID	Key	Type	Manage
FT0300	Shanghai (Otuangpu District), CN	Offline	ISHANG26	ondw70oa	PWS	Edit Delete

Items per page: 10 1 - 1 of 1

Figure 39

7. Wi-Fi Setup (Connect your Device to the Console's Wi-Fi)

 **Note:** If you own a dual band router (2.4 GHz and 5.0 GHz), make sure you connect to the 2.4 GHz band, otherwise it will fail to connect the weather station to Wi-Fi. You may need to check your router documentation regarding how to do this.

 **Note:** Wi-Fi connection requires the display console to use the power adaptor.

 **Note:** You should ensure you have created an online account as described in section 6, as you will be asked for the login details during the Wi-Fi setup.

When you first power up (AC) the console or press and hold the **MIN/MAX/-** button for three seconds in normal mode, the console icon (in front of the Indoor Temperature)  will flash to signify that it has entered WAP (wireless access point) mode, and is ready for you to enter Wi-Fi settings.

You can use a desktop computer, laptop, tablet, or smart phone to connect to the console's Wi-Fi. The console's network name begins with WeatherHome, followed by a unique code.

Note that when the console programming is complete, you will resume your default Wi-Fi connection.

Note that you cannot connect two or more devices at the same time in WAP mode.

Example 1:

Connect to the console Wi-Fi server with a PC.

Choose Wi-Fi network settings from Windows (or search "Change Wi-Fi Settings" from Windows) and Connect to the WeatherHome----- Wi-Fi network, as shown in Figure 40 (your Wi-Fi network name may be slightly different but will always begin with WeatherHome).

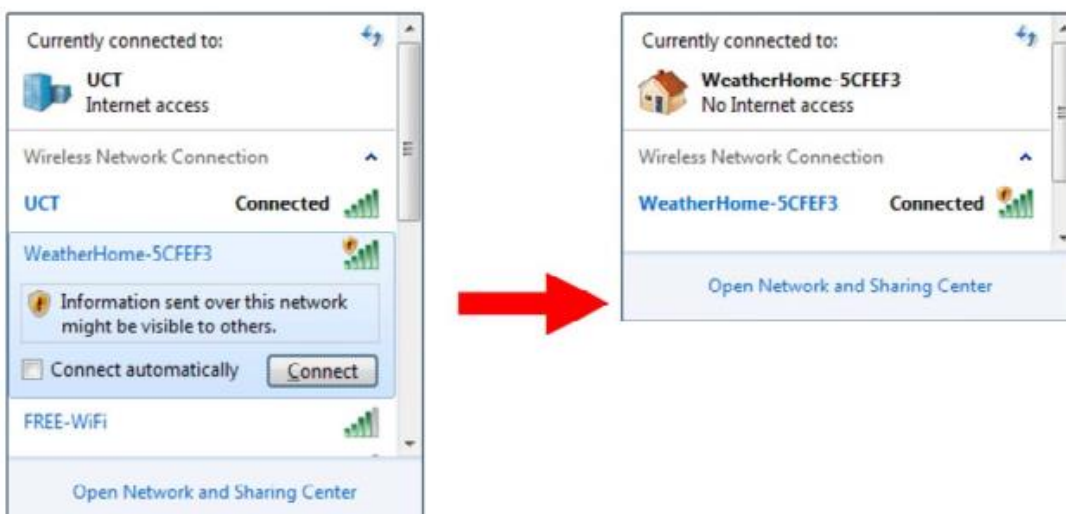



Figure 40

Example 2. Connect to the console Wi-Fi server with a Mac.

Choose the Settings icon  and  Network. Connect to the WeatherHome----- Wi-Fi network, as shown in Figure 41 (your Wi-Fi network name may be slightly different, but will always begin with WeatherHome-----).

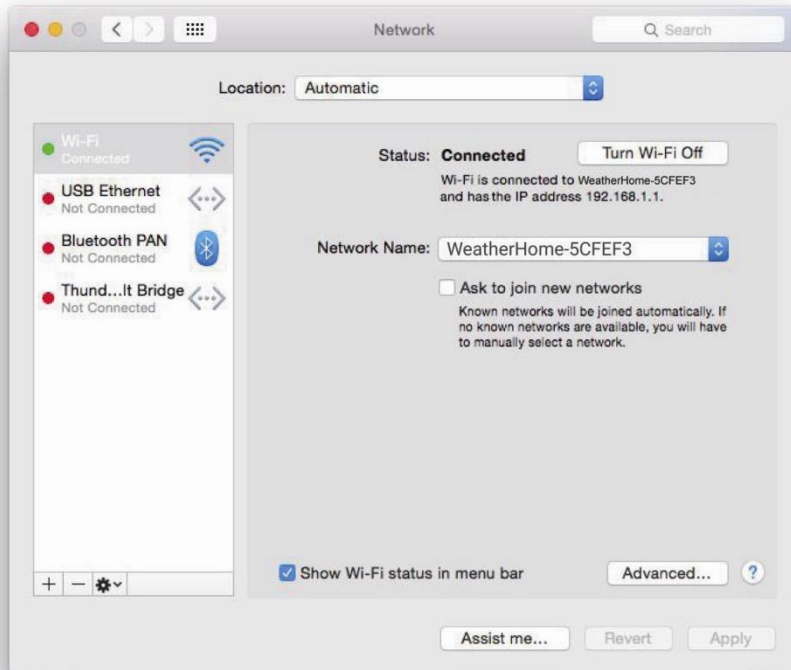

Figure 41

Example 3. Connect to the console Wi-Fi server with an iPhone or iPad.



Choose the Settings icon  and Wi-Fi. Connect to the WeatherHome----- Wi-Fi network, as shown in Figure 42 (your Wi-Fi network name may be slightly different but will always begin with WeatherHome-----).



Figure 42

Example 4. Connect to the console Wi-Fi server with an Android device.

From the Apps icon, choose the Settings icon  and Wi-Fi. Connect to the WeatherHome----- Wi-Fi network, as shown in Figure 43 (your Wi-Fi network name may be slightly different, but will always begin with WeatherHome-----).

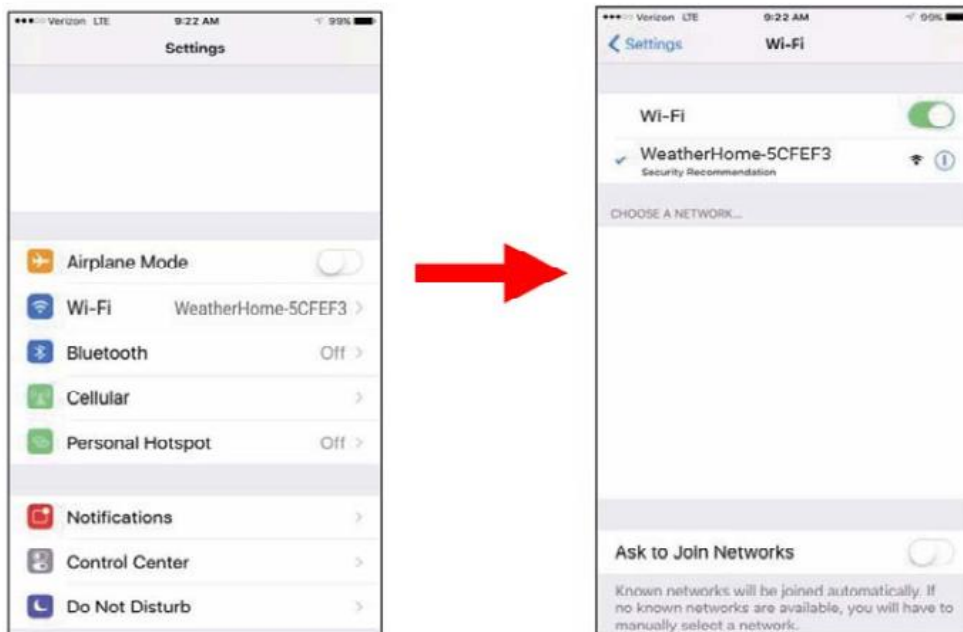



Figure 43

Once connected, enter the following IP address into any web browser: <http://192.168.5.1> to access the console's web interface.

 **Note:** Some browsers will treat 192.168.5.1 as a search, so make sure you include the header <http://>, i.e.: <http://192.168.5.1>, not 192.168.5.1

Enter the following information into the web interface (Figure 44). Make sure all of the information is entered prior to selecting Save. If you choose not to upload to Wunderground.com, or upload to weathercloud.net, leave the check boxes unchecked.

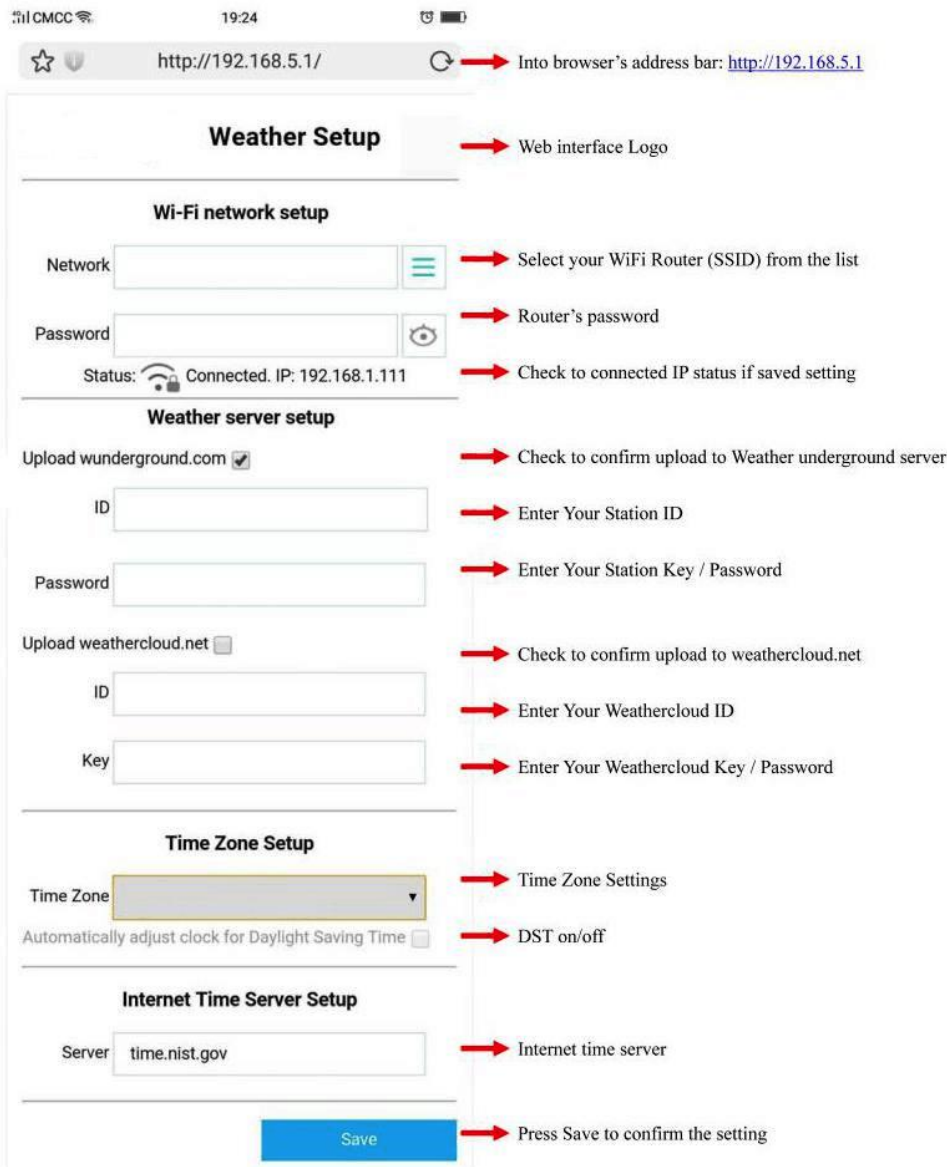



Figure 44

 **Note:** Hidden SSIDs: If you have a hidden SSID, enter the SSID manually.

Time Zone Settings (default: 0h). Based on the number of hours from Coordinated Universal Time, or Greenwich Mean Time (GMT).

The following table provides times zones throughout the world. Locations in the eastern hemisphere are positive, and locations in the western hemisphere are negative.

Hours from GMT	Time Zone	Cities
-12	IDLW: International Date Line West	---
-11	NT: Nome	Nome, AK
-10	AHST: Alaska-Hawaii Standard CAT: Central Alaska HST: Hawaii Standard	Honolulu, HI
-9	YST: Yukon Standard	Yukon Territory
-8	PST: Pacific Standard	Los Angeles, CA, USA
-7	MST: Mountain Standard	Denver, CO, USA
-6	CST: Central Standard	Chicago, IL, USA
-5	EST: Eastern Standard	New York, NY, USA
-4	AST: Atlantic Standard	Caracas
-3	---	São Paulo, Brazil
-2	AT: Azores	Azores, Cape Verde Islands
-1	WAT: West Africa	---
0	GMT: Greenwich Mean WET: Western European	London, England
1	CET: Central European	Paris, France
2	EET: Eastern European	Athens, Greece
3	BT: Baghdad	Moscow, Russia
4	---	Abu Dhabi, UAE
5	---	Tashkent
6	---	Astana
7	---	Bangkok
8	CCT: China Coast	Beijing

Hours from GMT	Time Zone	Cities
9	JST: Japan Standard	Tokyo
10	GST: Guam Standard	Sydney
11	---	Magadan
12	IDLE: International Date Line East NZST: New Zealand Standard	Wellington, New Zealand

If all of the information you entered is correct, press save to confirm (Figure 45). If it does not, check your web interface information again.







Figure 45

Once the setup is completed, disconnect your device from the console Wi-Fi. Otherwise, the console will automatically exit WAP mode. (Figure 46)



Figure 46

If the connection is successful, the Wi-Fi console's status Wi-Fi icon  will stop flashing and remain on.

 **NOTE:** When the console successfully connects to any weather server websites, the data signal icon  will appear on the LCD display (In front of the Indoor Temperature). If the data signal icon  is flashing, the console is currently uploading to the server. If the icon  disappears, the console has not connected to the weather server for more than 30 minutes.

7.1 Viewing your Data on Weather Underground

Visit: <http://www.wunderground.com/personal-weather-station/dashboard?ID=STATIONID>

where STATIONID is your personal station ID (example, KCALOSAN782).

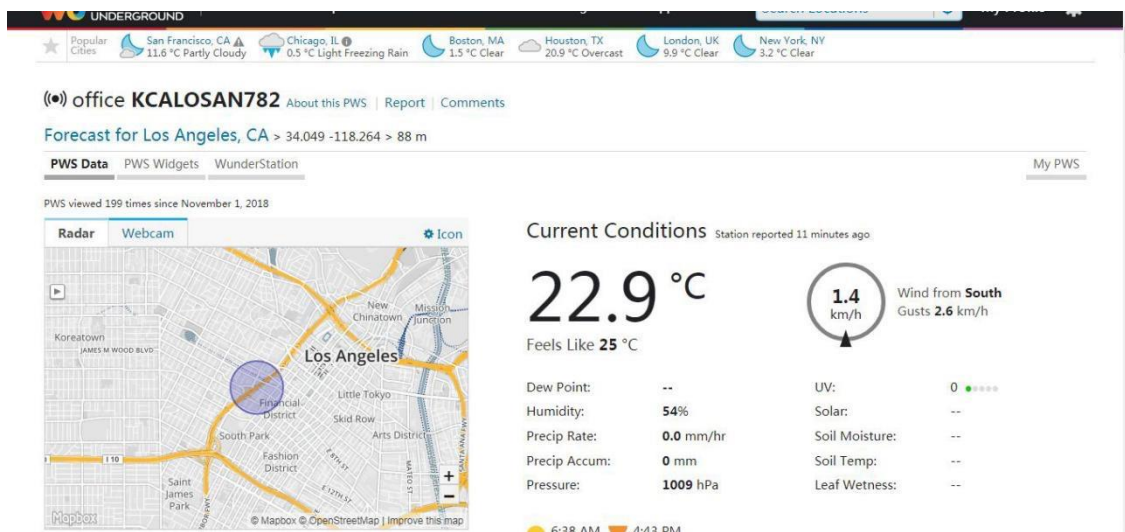

Figure 47

Multiple Sensor Features

Wunderground.com does not support multiple sensor channels.

 **Note:** The current temperature and humidity data is the Integrated Outdoor Transmitter.

7.2 View your data on Weathercloud.

Visit the website www.weathercloud.net and sign in with your email address and password. Then you will be automatically directed to the weather data of your weather station.

8. Upgrade firmware

You may get the latest firmware of the console as below.

When you first power up (AC) the console or press and hold the MIN/MAX/(Wi-Fi) button for three seconds in

normal mode, the console icon (behind the In/Outdoor humidity)  will flash to signify that it has entered WAP (wireless access point) mode, and is ready for you to enter WI-FI settings.

Use your smart phone, tablet, or computer to connect to the console through Wi-Fi (see: **Examples 1-4 in the Wi-Fi Setup section**).

Once connected, enter the following IP address into the browser's address bar:

<http://192.168.5.1/upgrade.html>



Figure 48

Once connection is successful, it will jump to the 'Upload Setting' screen automatically.

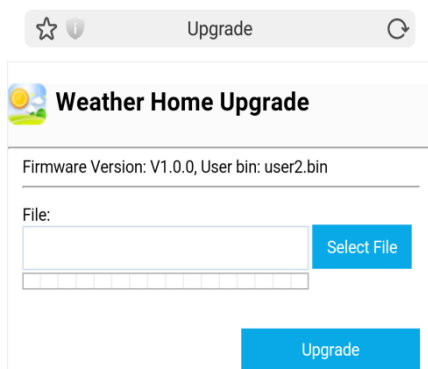

Figure 49

Press Select File button to select the upgraded firmware as shown in figure 50 below.

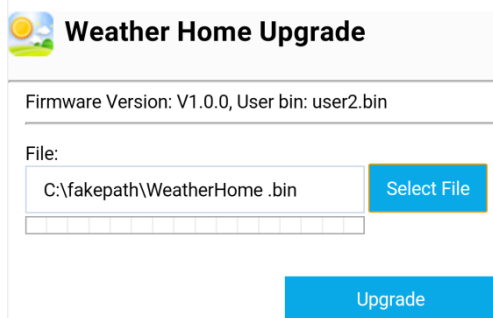

Figure 50

Press the Upgrade button. If the update was successful then you will see as per figure 51 below.

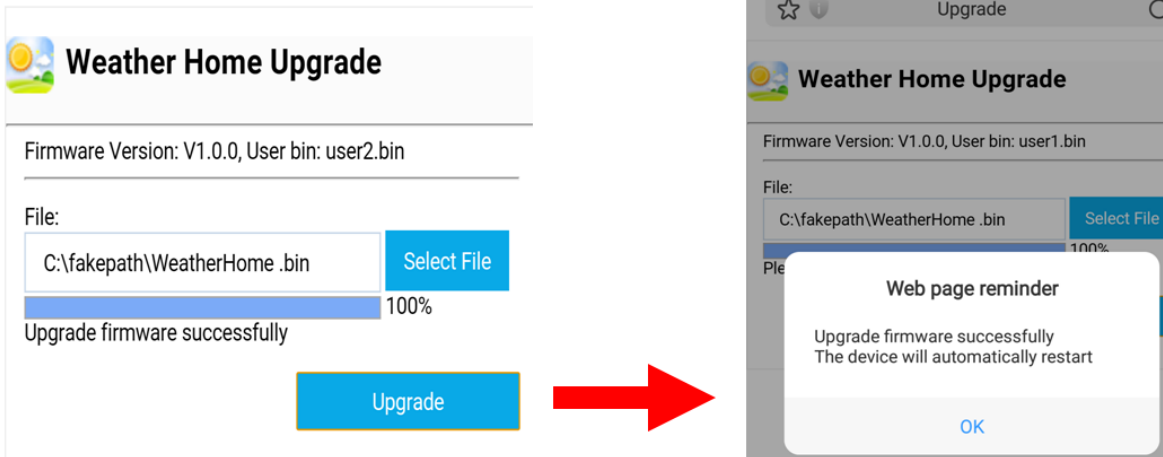

Figure 51

NOTE: In this upgrade only Wi-Fi firmware is updated. The console does not reset.

Once the upgrade is completed, the console will automatically exit WAP mode.

9. Other Console Features

The following section describes additional features and display icons.



Weather Forecasting

 **Note:** The weather forecast or pressure tendency is based on the rate of change of barometric pressure. In general, when the pressure increases, the weather improves (sunny to partly cloudy) and when the pressure decreases, the weather degrades (cloudy to rain).

The weather forecast is an estimation or generalisation of weather changes in the next 24 to 48 hours and varies from location to location. The tendency is simply a tool for projecting weather conditions and is never to be relied upon as an accurate method to predict the weather.

Weather Icons

Condition	Icon	Description
Sunny		Pressure is rising and the previous condition is partly cloudy.

Partly Cloudy		Pressure is falling and the previous condition is sunny or Pressure is rising and the previous condition is cloudy.
Cloudy		Pressure is falling and the previous condition is partly cloudy or Pressure is rising and the previous condition is rainy.
Rainy		Pressure is falling and the previous condition is cloudy.

Moon Phase

The following moon phases are displayed, based on the calendar date.

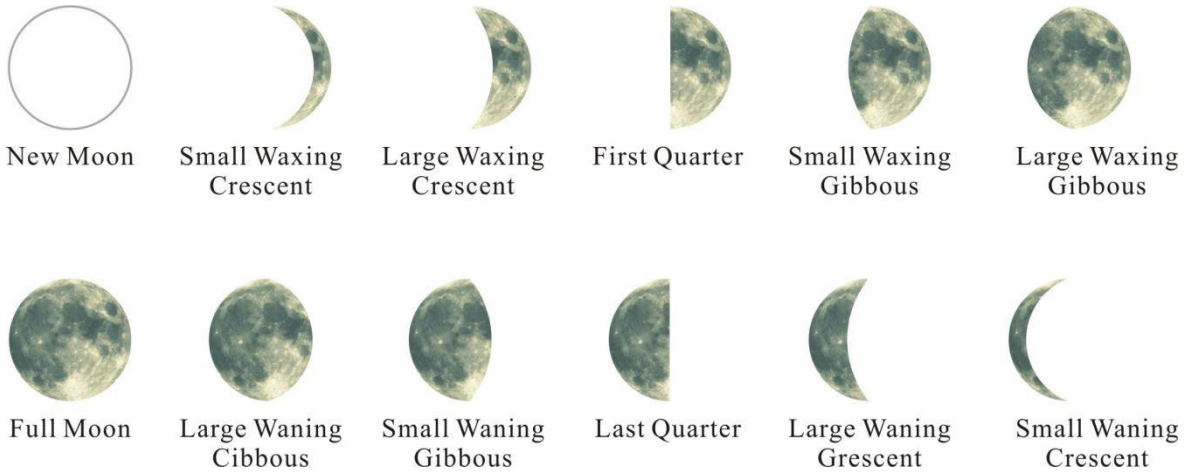

'Feels Like' Temperature and AT

'Feels like' temperature is a combination of Heat Index and Wind Chill.

At temperatures less than 4.4°C (40°F), the wind chill is displayed, as shown in the National Weather Service Wind Chill Table below:



NWS Windchill Chart

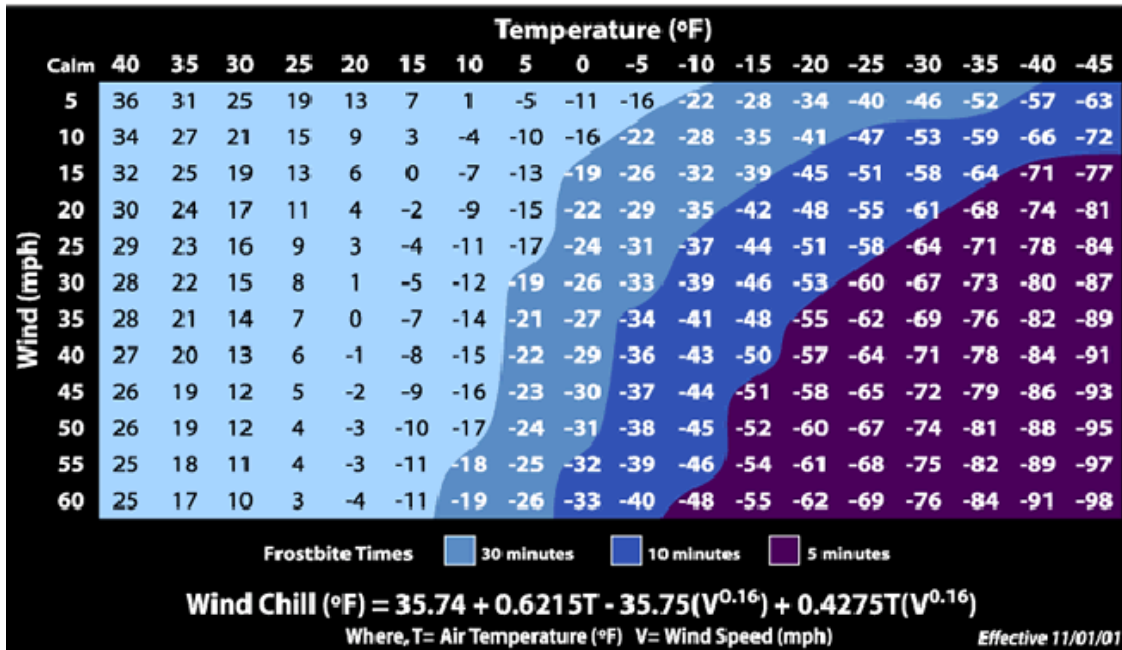
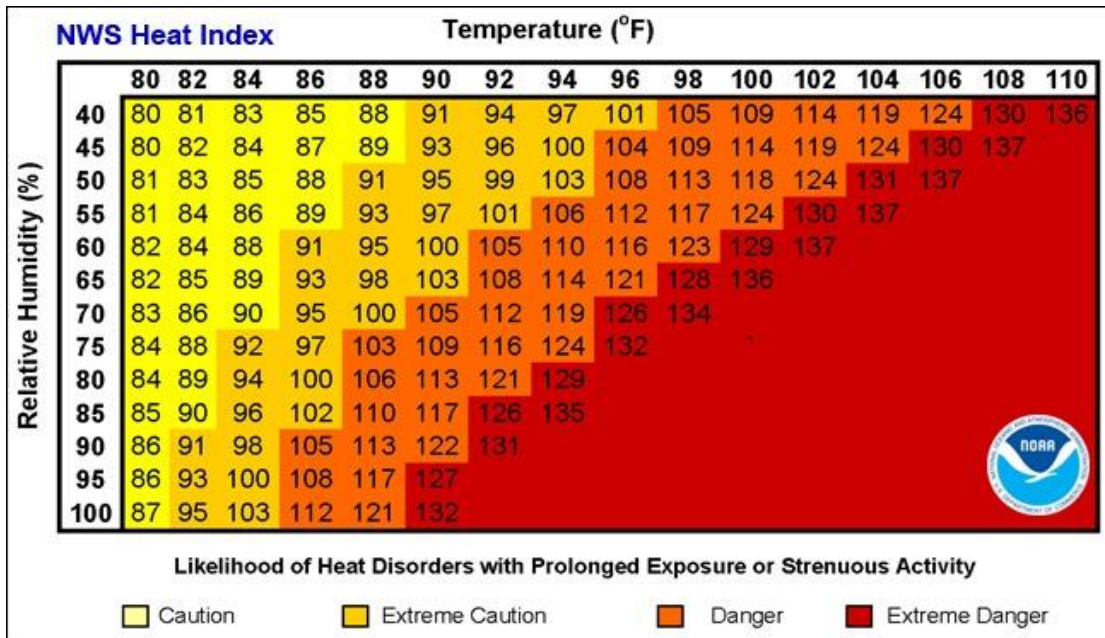

Figure 52

At temperatures greater than 26.7°C (80°F), the heat index is displayed, as shown in the National Weather Service Heat Index Table below:



When the temperature is between 4.4°C (40°F) and 26.7°C (80°F), the OUT temperature is displayed ('Feels Like' temperature is the same as OUT temperature).

The concept of apparent temperature (AT) is a linear regression that is not restricted and is more appropriate to outside conditions because it includes wind. and is intended as an assessment of what exposed body surfaces feel like in cold, windy conditions.

Regression equations of this universal scale are formulated for 'indoors'/'outdoors in shade but exposed to wind'/'outdoors exposed to wind and solar radiation'. Of these, 'outdoors in shade but exposed to wind', has been chosen as most informative.

Pressure Threshold Setting

The pressure threshold (the negative or positive rate of change of pressure signifying a change in the weather) can be adjusted from 2 mbar/hour to 4 mbar/hour (default level: 2 mbar/hour).

The lower the level pressure threshold setting, the higher sensitivity for weather forecast changes. Locations that experience frequent changes in air pressure require a higher setting compared to locations where the air pressure is typically stagnant.

14.6 Restore Factory Default

To restore the console to factory default (Wi-Fi network, Weather server and display), press the MIN/MAX/- button while installing the batteries at the same time. Wait 3 seconds after installing the batteries to let go of the MIN/MAX /- button.

10. Specifications

10.1 Wireless Specifications

- Line of sight wireless transmission (in open air): 100m
- Frequency: 433 MHz
- Integrated Outdoor Transmitter interval: 16 seconds.
- Thermo-hygrometer Transmitter update interval: 60 seconds

10.2 Measurement Specifications

The following table provides specifications for the measured parameters.

Measurement	Range	Accuracy	Resolution
Indoor Temperature	0 to 60 °C	± 1 °C	0.1 °C
Outdoor Temperature	-40 to 60 °C	± 1 °C	0.1 °C
Indoor Humidity	10 to 99 %	± 5% (only guaranteed between 20 to 90%)	1 %
Outdoor Humidity	10 to 99%	± 5% (only guaranteed between 20 to 90%)	1 %
Sensors 1-8 Temperature	-40 to 60 °C	± 1 °C	0.1 °C

Sensors 1-8 Humidity	10 to 99%	± 5% (only guaranteed between 20 to 90%)	1 %
UV Index	1 to 15+	± 1	± 1
Sunlight	0 to 200klux	± 15%	± 15%
Rain	0 to 9999mm	<15mm: ±1 mm, 15mm to 9999mm: ±7%	<1000mm (0.3mm) >1000mm (1mm)
Wind Direction	0 - 360 °	± 10° (16-point compass)	± 1° (16-point compass)
Wind Speed	0 to 50 m/s	2 m/s ~10 m/s: ±0.3m/s, 10m/s ~50 m/s: ±10% (whichever is greater)	0.1 m/s
Barometric Pressure:	300 to 1100 hpa	± 3 hpa	0.1 hpa

10.3 Power Consumption

- Base station (display console): 3 x AAA 1.5V Alkaline or Lithium batteries (not included).
- Adaptor: 6V~ 500mA (included).
- Integrated Outdoor Transmitter: 3 x AA alkaline batteries or Lithium batteries (not included).
- Thermo-hygrometer Sensor: 2 x AAA alkaline batteries or Lithium batteries (not included).
- Battery life: Typically at least 12 months for base station with excellent reception. Intermittent reception may reduce the battery life.
Typically at least 12 months for Integrated Outdoor Transmitter (use lithium batteries in cold weather climates less than -20 °C). The primary power source is the solar panel. The batteries provide backup power when there is limited solar energy.
Typically at least 12 months for sensors (use lithium batteries in cold weather climates less than -20 °C).

10.4 Wi-Fi Specifications

- Wi-Fi Standard: 802.11 b/g/n
- Wi-Fi Console RF Frequency: 2.4 GHz
- Recommended device to support setup: Smart device with built-in Wi-Fi with WAP mode, including laptops, computers, smart phones and smart pads.
- Recommended web browser for setup: Web browser which supports of HTML 5, such as the latest versions of Chrome, Safari, IE, Edge, Firefox or Opera.
- Line of sight Wi-Fi RF transmission (in open air): 20 metres (80 feet).

11. Maintenance

Clean the rain gauge of the Integrated Outdoor Transmitter once every 3 months.



- Unscrew the rain collector funnel by turning it 30° counter-clockwise.
- Gently remove the rain collector funnel.
- Clean and remove any debris or insects.
- Re-install the collector funnel after it has been cleaned and completely dried.



Figure 52

Replace the transmitter batteries every 1-2 years.

12. Troubleshooting Guide

Problem	Solution
<p>Wireless sensor not reporting into console.</p> <p>There are dashes (---) on the display console.</p>	<p>If the signal from any sensor is lost, dashes (---) will be displayed on the screen. To reacquire the signal, press and hold the CHANNEL/+ button for 3 seconds, choose the lost sensor and the remote search icon  will be constantly displayed. Once the signal is reacquired, the remote search icon  will turn off, and the current values will be displayed.</p> <p>The maximum line of sight communication range is 100m and 30m under most conditions. Move the sensor assembly closer to the display console.</p> <p>If the sensor assembly is too close (less than 1.5m), move the sensor assembly away from the display console.</p> <p>Make sure the remote sensor LCD display is working and the transmitter light is flashing once per 60 seconds.</p> <p>Install a fresh set of batteries in the remote thermo-hygrometer. For cold weather environments, install lithium batteries.</p> <p>Make sure the remote sensors are not transmitting through solid metal (acts as an RF shield), or earth barrier (down a hill).</p> <p>Move the display console away from electrical noise generating devices, such as computers, TVs and other wireless transmitters or receivers.</p> <p>Move the sensor to a higher location. Move the remote sensor to a closer location.</p>
<p>Temperature sensor reads too high in the daytime.</p>	<p>Make sure the thermo-hygrometer is mounted in a shaded area. The pre preferred location is a north facing wall because it is in the shade most of the day.</p>
<p>Indoor and Outdoor Temperature do not agree</p>	<p>Allow up to one hour for the sensors to stabilise due to signal filtering. The indoor and outdoor temperature sensors should agree within 2 °C (the sensor accuracy is ± 1 °C).</p>

Problem	Solution
	Use the calibration feature to match the indoor and outdoor temperature to a known source.
Indoor and Outdoor Humidity do not agree	<p>Allow up to one hour for the sensors to stabilise due to signal filtering. The indoor and outdoor humidity sensors should agree within 10 % (the sensor accuracy is ± 5 %).</p> <p>Use the calibration feature to match the indoor and outdoor humidity to a known source.</p>
Display console contrast is weak	Replace console batteries with a fresh set of batteries.
Wi-Fi does not display on console.	<p>Check your router for problems.</p> <ol style="list-style-type: none"> 1. Check Wi-Fi symbol on the display. If wireless connectivity is successful, the Wi-Fi icon  will be displayed in the time field. 2. Make sure your modem Wi-Fi settings are correct (network name, and password). 3. Make sure the console is plugged into AC power. The console will not connect to Wi-Fi when powered by batteries only. 4. The console only supports and connects to 2.4 GHz routers. If you own a 5 GHz router, and it is a dual band router, you will need to disable the 5 GHz band, and enable the 2.4 GHz band. 5. The console does not support guest networks.

Problem	Solution
Data not reporting to www.wunderground.com or www.weathercloud.net	<ol style="list-style-type: none"> 1. Confirm your password or key is correct. It is the password you registered on Wunderground.com. Your Wunderground.com password cannot begin with a non-alphanumeric character (a limitation of Wunderground.com, not the station). Example, \$worknet is not a valid password, but worknet\$ is valid. 2. Confirm your station ID is correct. 3. Make sure the date and time is correct on the console. If incorrect, you may be reporting old data, not real time data. 4. Make sure your time zone is set properly. If incorrect, you may be reporting old data, not real time data. 5. Check your router firewall settings. The console sends data via Port 80.

13. Adjustment or Calibration

The purpose of calibration is to fine-tune or correct for any sensor error associated with the device's margin of error. The measurement can be adjusted from the console to calibrate to a known source.

Calibration is only useful if you have a known calibrated source you can compare it against, and is optional. This section discusses practices, procedures and sources for sensor calibration to reduce manufacturing and degradation errors. Do not compare your readings obtained from sources such as the internet, radio, television or newspapers. They are in a different location and typically update once per hour.

The purpose of your weather station is to measure conditions of your surroundings, which vary significantly from location to location.

 **Note:** The calibrated value can only be adjusted on the console. The remote sensor(s) always displays the un-calibrated or measured value.

 **Note:** The measured humidity range is between 10 and 99%. Humidity cannot be accurately measured outside of this range. Thus, the humidity cannot be calibrated below 10% or above 99%.

1. Temperature Calibration

In normal mode, press and hold the **SET** and **CHANNEL/+** buttons at the same time for five seconds to enter the temperature calibration mode. The indoor temperature will begin flashing.

Press the **[+]** or **[-]** button to increase or decrease the temperature reading (in increments of 0.1). Press and hold the **[+]** or **[-]** button for three seconds to increase or decrease rapidly.

Press the **ALARM** button to reset to the current value.

Press the **SET** button to switch between indoor, outdoor and temperature channels 1 through 8. To exit the calibration mode at any time, press the **SNOOZE/LIGHT** button on the top of the display console. If no operation is performed, the calibration mode will timeout in 30 seconds.

2. Humidity Calibration

In normal mode, press and hold the **SET** and **MIN/MAX/-** buttons at the same time for five seconds to enter the humidity calibration mode. The indoor humidity will begin flashing.

Press the **[+]** or **[-]** button to increase or decrease the humidity reading (in increments of 1%). Press and hold the **[+]** or **[-]** button for three seconds to increase or decrease rapidly.

Press the **ALARM** button to reset current value.

Press the **SET** button switch to indoor, outdoor and humidity channels 1 through 8. To exit the calibration mode at any time, press the **SNOOZE/LIGHT** button on the top of the display console. If no operation is performed, the calibration mode will timeout in 30 seconds.

 **Note:** Humidity is a difficult parameter to measure accurately and drifts over time. The calibration feature allows you to zero out this error. To calibrate humidity, you will need an accurate source, such as a sling psychrometer or Humidipaks One Step Calibration kit.

3. Absolute and Relative Barometer, Wind and Rain Calibration

1. Quick Reference Guide

Command	Mode	Default	Settings
[SET] + [ALARM] + 3 seconds	Absolute Barometer Offset	0.00	Press [+] or [-] to adjust the absolute pressure up or down. Note that you normally not calibrate absolute pressure unless you have a specific application example, measuring air density.
[SET]	Relative Barometer Offset	0.00	Press [+] or [-] to adjust the relative pressure offset up or down. See discussion below on how to calibrate relative pressure based on conditions at a local airport.
[SET]	Wind Gain	1.00	Press [+] button or [-] to adjust the wind gain up or down.
[SET]	Rain Gain	1.00	Press [+] button or [-] to adjust the rain gain up or down.
[SET]	Sunlight	1.00	Press [+] button or [-] to adjust the rain gain up or down.
[SET]	Exit Calibration Mode		

2. Step by Step Guide

In normal mode, press and hold the **SET** and **ALARM** buttons at the same time for five seconds to enter the barometer, wind speed, rainfall and calibration mode. To skip over a parameter, press (do not hold) the SET button. The word CAL will appear at the top of the screen.

1. Absolute Pressure Calibration

The absolute pressure offset will begin flashing. The default offset is 0.00 inHg.

Press the **[+]** or **[-]** button to increase or decrease the absolute pressure offset.

Press and hold the **[+]** or **[-]** button for three seconds to increase or decrease rapidly.

Press the **ALARM** button to reset current value.

Example: The calibrated pressure source measures 28.00 inHg. The display absolute pressure reads 28.83 inHg on the console.

Offset = 28.00 – 28.83 = 0.83 inHg.

2. Relative Pressure Calibration

Press the **SET** button and the relative pressure offset will flash. The default is 0.00 inHg

Press the **[+]** or **[-]** button to increase or decrease the relative pressure offset.

Press and hold the **[+]** or **[-]** button for three seconds to increase or decrease rapidly.

Press the **ALARM** button to reset current value.

Example: The local official barometer measures 30.00 inHg. The display absolute pressure reads 29.92 inHg on the console.

Offset = 30.00 – 29.92 = 0.08 inHg.



Note: The display console displays two different pressures: absolute (measured) and relative (corrected to sea-level).

To compare pressure conditions from one location to another, meteorologists correct pressure to sea-level conditions. Because the air pressure decreases as you rise in altitude, the sea-level corrected pressure (the pressure your location would be at if located at sea-level) is generally higher than your measured pressure.

Thus, your absolute pressure may read 28.62 inHg (969 mb) at an altitude of 1000 feet (305 m), but the relative pressure is 30.00 inHg (1016 mb).

The standard sea-level pressure is 29.92 in Hg (1013.2hpa). This is the average sea-level pressure around the world. Relative pressure measurements greater than 29.92 inHg (1013.2hpa) are considered high pressure and relative pressure measurements less than 29.92 inHg are considered low pressure.

To determine the relative pressure for your location, locate an official reporting station near you (the internet is the best source for real time barometer conditions, such as Weather.com or Wunderground.com), and set your weather station to match the official reporting station.

3. Wind Gain Calibration

Press the **SET** button and the wind gain will flash. The default is 1.00.

Press the **[+]** or **[-]** button to adjust the wind speed calibration factor from 0.75 to 1.25, where:

Calibrated Wind Speed = Calibration factor x Measured Wind Speed

Press and hold the [+] or [-] button for three seconds to increase or decrease rapidly.

Press the **ALARM** button to reset current value.



Note: The wind gust is also affected by the wind speed calibration factor.



Discussion: Wind speed and wind gust are adversely affected by installation constraints. The rule of thumb is to install the weather station four times the distance of the height of the tallest obstruction (For example, if the building is 20ft tall, and the mounting pole is 6ft tall, install $4 \times (20 - 6) \text{ ft} = 56\text{ft}$ away.).

In many instances, due to trees and other obstructions, this is not possible. The wind speed calibration allows you to correct for these obstructions.

In addition to installation challenges, wind speed bearings (any moving part) wears over time. To correct for wear, the correction value can be increased until the wind cups must be replaced.

Without a calibrated source, wind speed is a difficult parameter to measure. We recommend using a calibrated wind meter and constant, high-speed fan.

4. Rain Calibration

Press the **SET** button again and the Rain Calibration value will begin flashing (the default is 1.0). Press the [+] or [-] button to adjust the rain calibration factor from 0.75 to 1.25, where:

Calibrated Rain = Calibration factor x Measured Rain

Press and hold the [+] or [-] button for three seconds to increase or decrease rapidly.

Press the **ALARM** button to reset current value.



Discussion: The rain collector is calibrated at the factory based on the funnel diameter. The bucket tips every 0.01 inch of rain (referred to as resolution). The accumulated rainfall can be compared to a sight glass rain gauge with an aperture of at least 4 inches.



Note: Debris and insects can collect inside the tipping mechanism (they make a good spider's nest). Carefully remove the funnel and inspect the tipping mechanism for debris prior to calibration.

5. Sunlight Calibration

Press the **SET** button again and the sunlight Calibration value will begin flashing (the default is 1.0). Press the [+] or [-] button to adjust the sunlight calibration factor from 0.75 to 1.25, where:

Calibrated Sunlight = Calibration factor x Measured Sunlight

Press and hold the [+] or [-] button for three seconds to increase or decrease rapidly.

Press the **ALARM** button to reset current value.



Discussion: Place the UV and Sunlight sensor in a sunny position.

14. Service

Please contact us for any questions regarding the product or claims, preferably by email.

ACCUR8
Ford Lane Business Park
Ford
West Sussex
BN18 0UZ
UK

Email: info@accur8tech.com

Phone: 01243 558 280

15. EC Declaration of Conformity

Tempcon Instrumentation Limited declares that the equipment type with item number DWS7100 complies with EMC Directive 204/108/EC. The full text of the declaration of conformity is available on request from the address above.

16. UKCA Declaration of Conformity

Tempcon Instrumentation Ltd has issued a declaration of conformity in accordance with applicable guidelines and corresponding standards. The full text of the UKCA declaration of conformity is available on request from the address above.

17. Disposal

Dispose of the packaging materials properly, according to their type, such as paper or cardboard. Contact your local waste-disposal service or environmental authority for information on the proper disposal.

Do not dispose of electronic devices in the household rubbish! As per Directive 2012/19/EC of the European Parliament on waste electrical and electronic equipment, used electronic devices must be collected separately and recycled in an environmentally friendly manner.

Do not dispose of batteries and rechargeable batteries with the household waste. You are legally required to return used batteries and rechargeable batteries. After they are used, the batteries can be returned free of charge to our point of sale or to a nearby location (for example, retailers or municipal collecting points). Batteries and rechargeable batteries are marked with a symbol of a crossed-out dustbin and the chemical symbol of the pollutant. "Cd" stands for Cadmium, "Hg" stands for mercury and "Pb" stands for lead.