

PURSE ORGANIZER SHORT

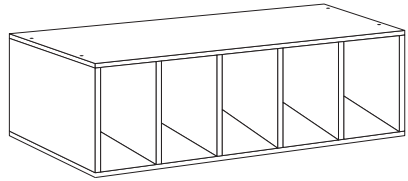

Included



28 Pins

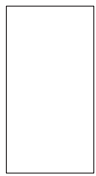

5 Backer Boards
(thin and no adhesive)

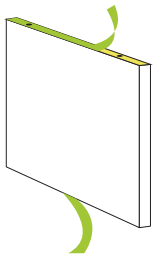

2 Vertical zBoards
(groove on one side)

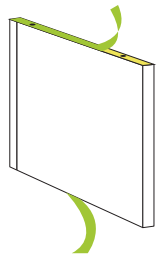

4 Vertical zBoards
(groove on both sides)

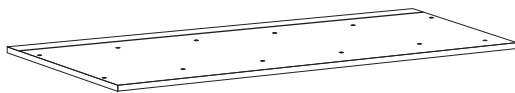

2 Horizontal zBoards



WARNING: CHOKING HAZARD
Small parts NOT for children under 3 years



- Assemble your unit on a flat even surface
- Make sure zBoard surfaces are clean and dry

- Do not place unit on its side or back as it will compromise its structural integrity
- Indoor use only. Not in bathroom

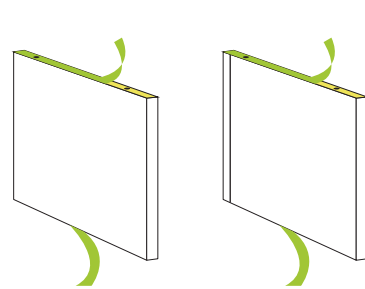

- 1** Carefully remove the protective layer on the Vertical zBoards, making sure not to remove the 3M adhesive.

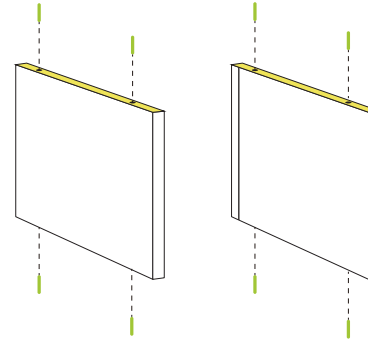

- 2** Insert pins as shown.

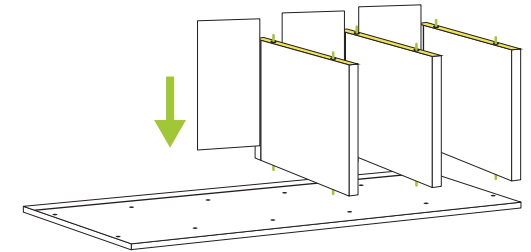

- 3** Align Vertical zBoard and Backer Boards as shown to Horizontal zBoard.

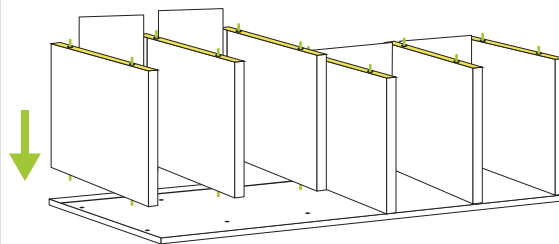

- 4** Continue to align Vertical zBoards and Backer Boards to Horizontal zBoard.

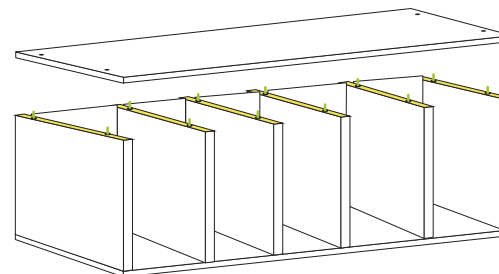

- 5** Align Horizontal zBoard on top of the Vertical zBoards and press firmly to secure unit together.

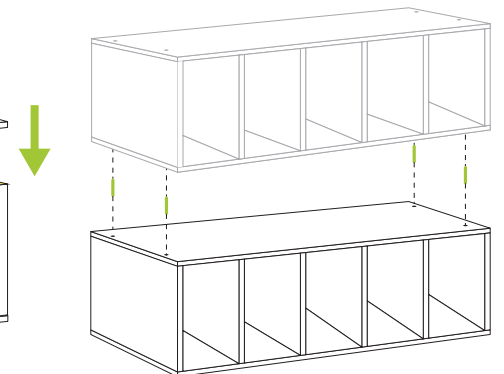

- 6** Easily expand your storage with another stacking unit. Use alignment pins to keep the units from sliding. Enjoy building possibilities!

