

# CD / DVD RACK

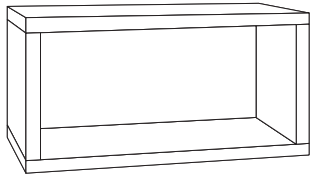

## Included

12 Pins

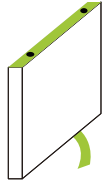

2 Vertical zBoards

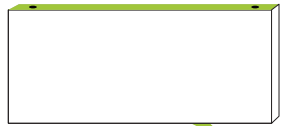

1 Back zBoard

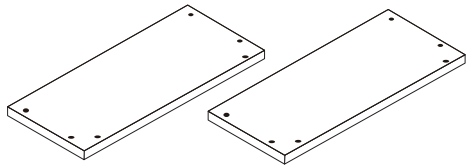

1 Top zBoard

1 Bottom zBoard

**WARNING: CHOKING HAZARD**  
Small parts NOT for children under 3 years

## Important

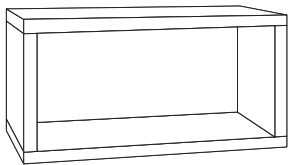

THIS SIDE UP

**CAUTION** placing unit on its side or back will compromise structural integrity. Use right side up.



- Assemble your unit on a flat even surface
- Make sure zBoard surfaces are clean and dry

- When moving your Way Basics unit, lift from the bottom
- Indoor use only. Not in bathroom.

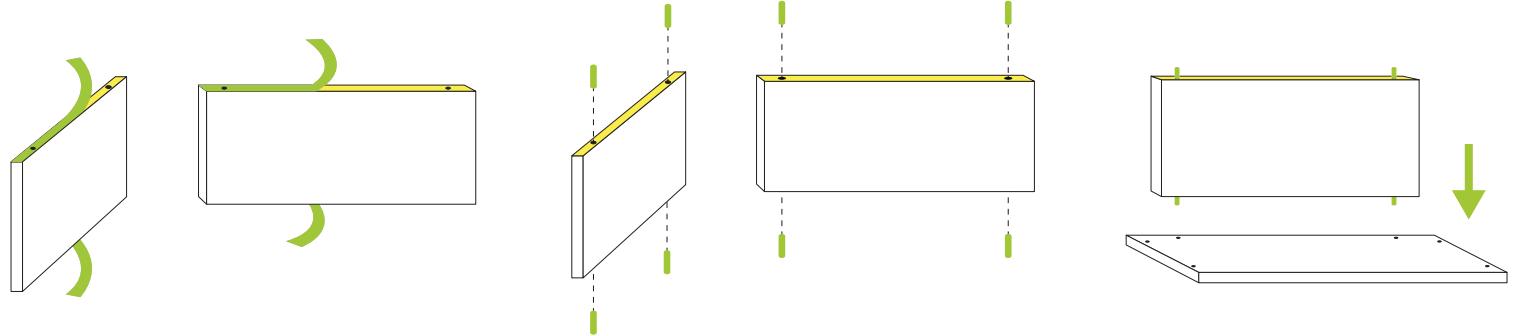

**1** Carefully remove the protective layer on the Back and Vertical zBoards, making sure not to remove the 3M adhesive.

**2** Insert pins as shown.

**3** Align Back zBoard to holes in the Bottom zBoard.

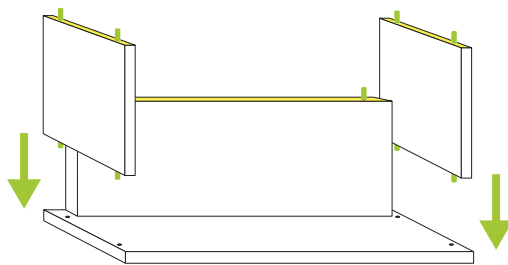

**4** Align Vertical zBoards to holes in Bottom zBoard

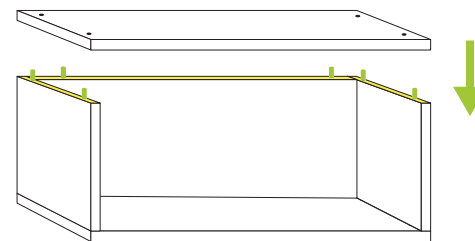

**5** Align Top zBoard and press firmly to secure unit together.

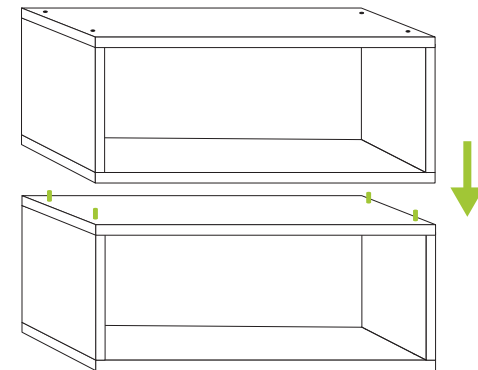

**6** Stack the second unit and press firmly to secure unit together.

Enjoy building possibilities!

