

CONNECT DOOR CUBE

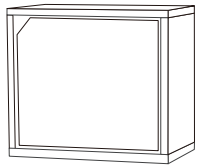

Included



8 Alignment Pins
4 connectors pins

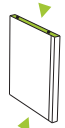

2 Vertical zBoards
adhesive strips on 2 edges

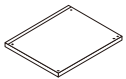

1 Bottom zBoard
with door pin slot

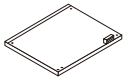

1 Top zBoard
with magnetic door stopper



1 Backer Board
thin and has no adhesive



1 zBoard Door



WARNING: CHOKING HAZARD
Small parts NOT for children under 3 years

Important

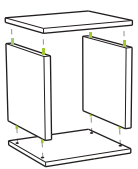

↑
THIS SIDE UP

Tip Start assembly from bottom to top.

DO NOT place unit on its side or back as it will compromise its structural integrity.



- Assemble your unit on a flat even surface, carpet not recommended
- Furniture is for indoor use only

- When moving your Way Basics furniture, lift from the bottom
- Make sure zBoard surfaces are clean and dry

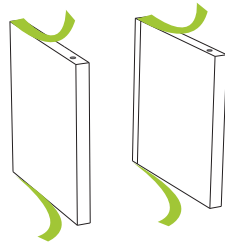

1 Carefully remove the 3M protective layer from adhesive.

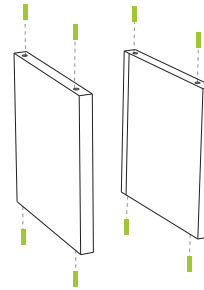

2 Place alignment pins in vertical zBoards.

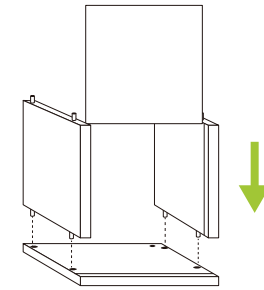

3 Align vertical zBoards and backer board to bottom zBoard.

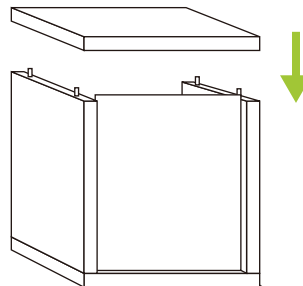

4 Align top zBoard.

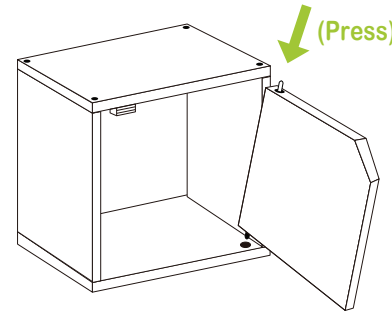

5 Orient door properly as shown and align bottom pin. Press on spring loaded top pin and insert.

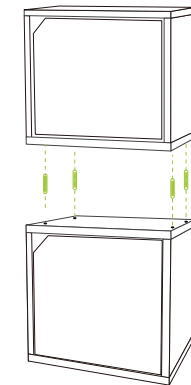

6 Join other connect cubes with connector pins! Visit links below for more details. Enjoy building possibilities!

Note Use included decals to cover the connector holes if not stacking cubes.

