

VINYL RECORD SHELF AND BOOKSHELF

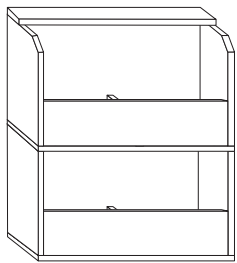

way basics

Newport Beach est. 2008



Included



38 Pins

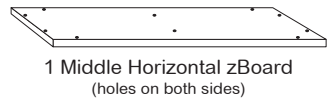

1 Middle Horizontal zBoard
(holes on both sides)

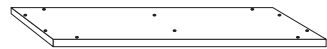

1 Bottom zBoard
(holes on one side)

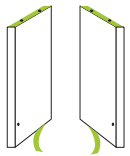

2 Bottom Vertical zBoards

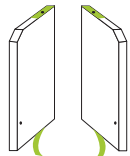

2 Top Vertical zBoards (cut corner)



2 Front zBoards

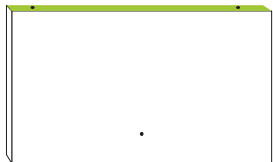

2 Back zBoards

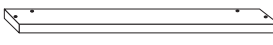

1 Narrow Top zBoard

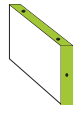

2 Short Vertical zBoards

Important

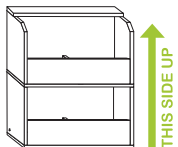

THIS SIDE UP

DO NOT place unit on its side or back as it will compromise its structural integrity.

WARNING: CHOKING HAZARD
Small parts NOT for children under 3 years



- Assemble your unit on a flat even surface
- Make sure zBoard surfaces are clean and dry

- When moving your Way Basics unit, lift from the bottom
- Use indoors and in dry areas only. Do not use in the bathroom

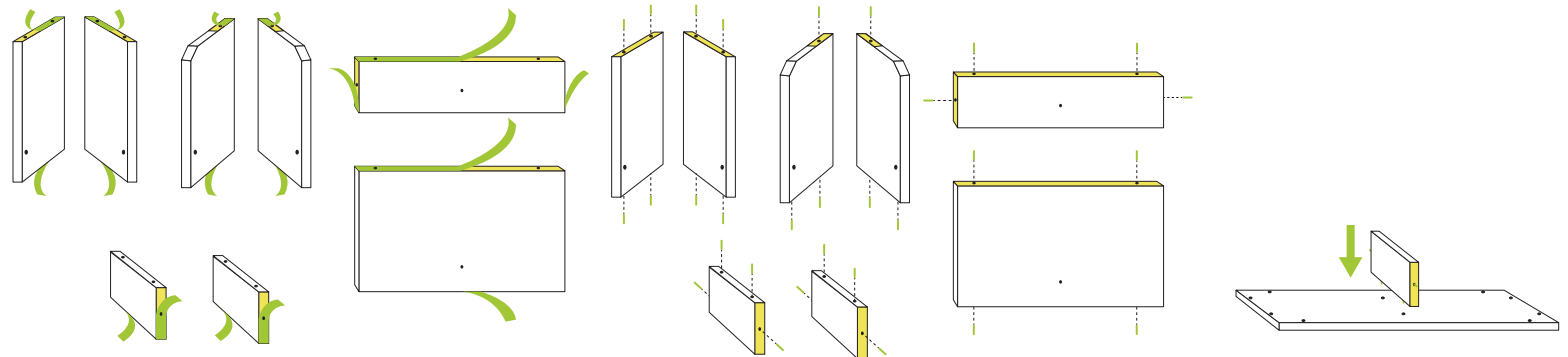

1

Carefully remove the protective layer on all zBoards (**making sure not to remove the 3M adhesive shown in yellow**).
Tip: Peel protective layer from side.

2

Insert pins as shown.

3

Align one Short Vertical zBoard to the middle holes in Bottom zBoard as shown.

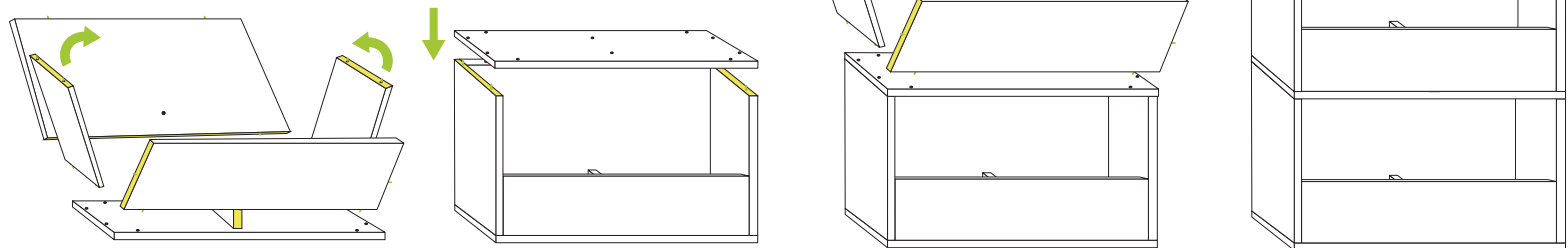

4

First align the Front, Back and Short Vertical zBoards to the Bottom zBoard as shown. Then align the Bottom Vertical zBoards to Bottom zBoard and sandwich the Front and Back zBoards as shown.

5

Align the Middle Horizontal zBoard as shown.

6

First align the Front, Back and Vertical zBoards to the Bottom zBoard as shown. Then align the Top Vertical zBoards to Middle zBoard and sandwich the Front and Back zBoards as shown.

7

Align Narrow Top zBoard as shown and press firmly to secure unit together.



Contact Us www.waybasics.com/contact



Need Help? Call or text 949 229 3304

version 1121