

# CAT SCRATCHER FLOATING SHELVES

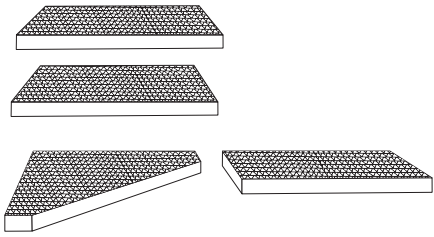

## Included

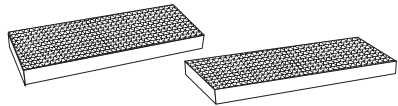

2 Rectangle Scratcher Shelves

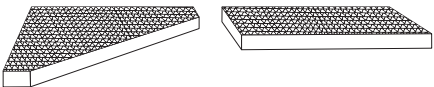

1 Triangle Scratcher Shelf

1 Slim Rectangle Scratcher Shelf

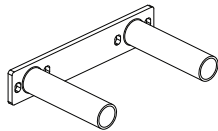

4 Brackets



16 Plastic Anchors



16 Screws

## Tools Needed Not Included



Level



Phillips Screwdriver



Power Drill + 1/4" Drill Bit



• Make sure zBoard surfaces are clean and dry

• Use indoors and in dry areas only. Do not use in the bathroom

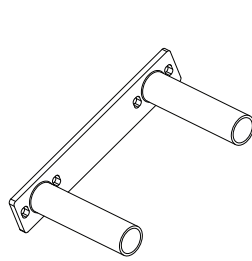

1 Place bracket on the wall.

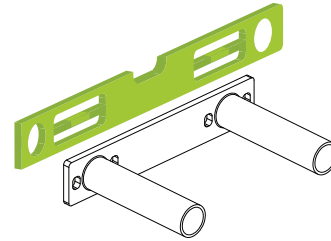

2 Level bracket.

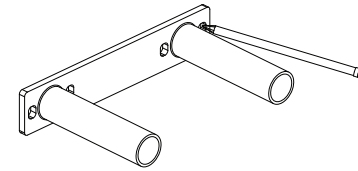

3 Mark 4 holes onto wall with pencil.

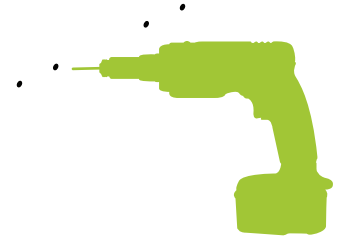

4 Drill 4 holes into wall with 1/4" bit.

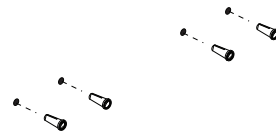

5 Insert anchors into holes.

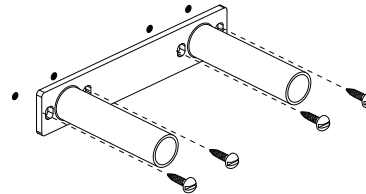

6 Fasten bracket to wall anchors with screws.

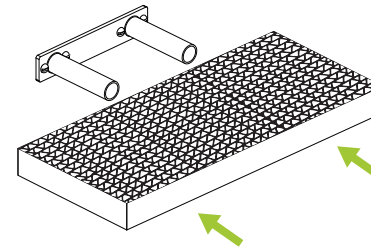

7 Insert shelf onto bracket.

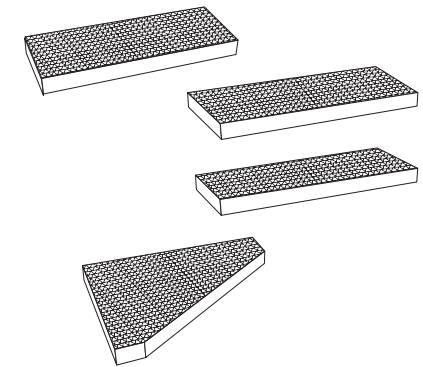

8 Repeat steps 1-7 for the other shelves.



WARNING: CHOKING HAZARD  
Small parts NOT for children under 3 years

