



# GDO blaQ

Smart Garage Door Opener Accessory  
for Security+ and Security+ 2.0 garage openers



Installation Guide | GDOv2-Q

## STEP 3: Physical Setup

### Check Wi-Fi Signal in Garage

Move the device into the garage and plug it in.

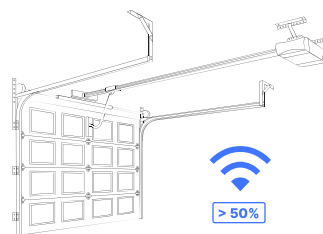

Tap **Open Web Page** to see the internal web interface of the Konnected GDO. Scroll down to **WiFi Signal %** to see the signal strength.

Ensure that the signal strength is **at least 50%** for best results.

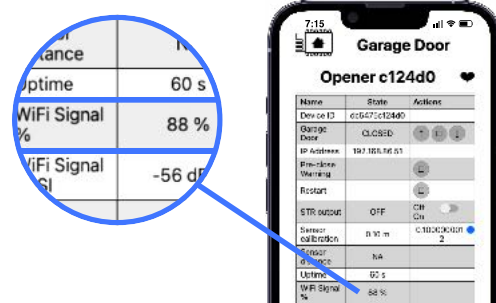

Make your garage door opener smart! The **Konnected Garage Door Opener** retrofits an older garage door opener, letting you open or close it and know if it's open in real-time with your favorite smart home app.

Works with most Chamberlain, LiftMaster, Craftsman and Merlin brand garage openers. Check the learn button color:



### Kit Contents

1. Smart Garage Door Opener
2. Power Adapter
3. Hook-Up Wire
4. Mounting accessories
5. Wall sticker

Scan for full documentation

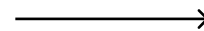

### WARNING

To reduce the risk of injury to persons—

- Only install this product on a sectional garage door.
- Do not use this device with one-piece doors or swinging doors.
- Use only with garage door openers manufactured after 1993 with a functional obstruction sensor (beam).
- Do not disable the built-in audible and visual pre-closing warning.

### IMPORTANT SAFETY INSTRUCTIONS

- Read and follow these instructions.
- Unplug all devices during installation to avoid the risk of electric shock and unwanted garage door movement.
- Do not install in a wet or damp location or allow to be exposed to moisture or weather.
- Secure all wires and cables to prevent them from falling in the path of the moving garage door or vehicles.
- When using a ladder, follow all warnings to avoid injury.
- Affix the warning sticker near the garage wall button.

### AUTOMATE SMART

This product provides the capability to automate the opening and closing of the garage door, potentially providing ingress to your home. **YOU MUST EXERCISE CAUTION** and due diligence when implementing such automations. **ALWAYS THOROUGHLY TEST ALL AUTOMATIONS** and ensure that the device's sensor is correctly and consistently reporting the state of the garage door.

## STEP 1: Initial Setup

### Connect to Wi-Fi

Connect your new GDO to Wi-Fi before installing it in the garage. Power on the device by plugging in the included power adapter. Using a smart phone or computer, connect to the WiFi network:

📶 **konnected-xxxxxx**

if the Wi-Fi connection page doesn't open automatically, then open your browser and go to:

🌐 <http://192.168.4.1>

Select your Wi-Fi network and enter your password:



## Find it Online

Download and install the Konnected app to easily discover and set up your GDO.



📍 You can also go to the device's IP address directly (without needing the Konnected app) by finding it in your router's app.

Go to **Add New Device** from the app menu to search for the device on your network.

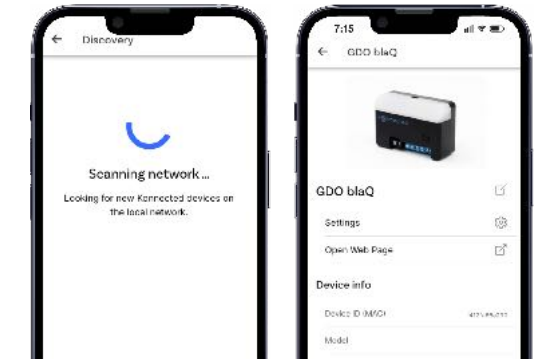

Next step—flip over to connect to smart home platform

### Mounting Option 1: Near the garage door motor

The GDO blaQ can be mounted on the ceiling, on the garage opener support beams, or on the garage opener itself and wired to the garage opener motor unit. Or, mount it on the wall and wire it to the wall button. Choose a location that has a nearby power outlet to plug it in, and mount it in an orientation so that the warning light is visible in the garage.

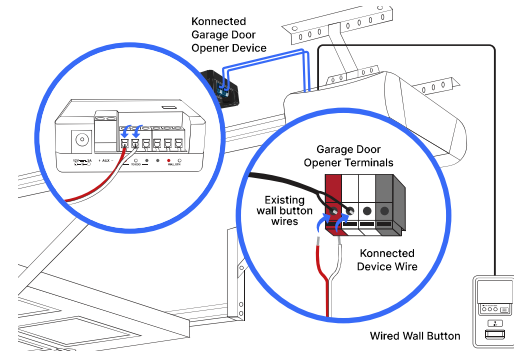

The simplest installation requires connecting only one pair of red and white wires. **Leave all existing wires in-place** and insert one end of the red and white wire into red and white terminals on back of the garage opener motor. Insert the other ends into the red and white terminals labeled TO GDO on the Konnected device. Secure the wire out of the way of the path of the moving garage door and mount the device using the included mounting screws or command strips.

### Mounting Option 2: Near the wall button

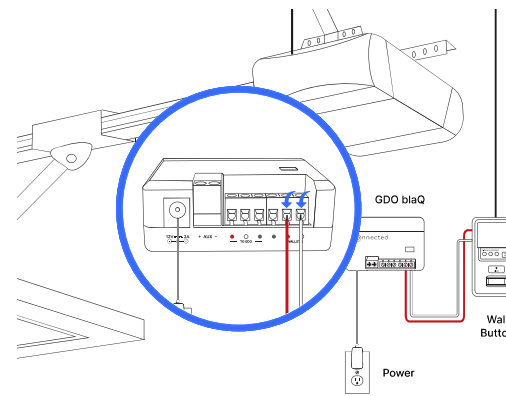

To mount on near the wall button, **leave all existing wires in-place** and connect one end of the red and white wires to the corresponding screws marked RED and WHITE (or R and W) on the back of the wall button, and the other end to the red and white terminals marked WALL BTN.

### Optional: Additional Input

Either of the gray terminals may be used for an additional dry-contact input, such as a contact sensor or motion sensor. To connect a contact sensor, use the gray and white terminals. For a motion sensor, additionally connect to AUX +/- for power.

### Optional: Pass-thru wiring

If it's too difficult to fit the additional wires for the GDO blaQ into the terminals with the existing button wires, the device is equipped with a pass-thru feature to make wiring cleaner.

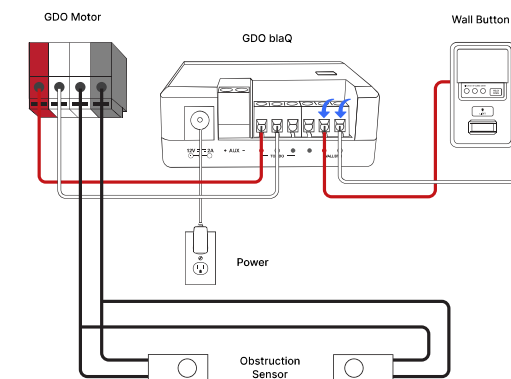

First, **remove** the wall button wires from the red and white terminals on the back of the motor unit and **reconnect them** to the red and white terminals labeled WALL BTN on the Konnected device.

Then, connect the new red and white wire in their place, and connect the other ends to the red and white terminals labeled TO GDO. **Leave the existing wires for the obstruction sensor beam in place.**

### Test Opening and Closing

Use your smart home app or the device's internal web page to test the open and close functions and check that the door status is read correctly. Open and close the door completely *without stopping* after setup. This is so the device can time how long it takes to open and close the door completely.

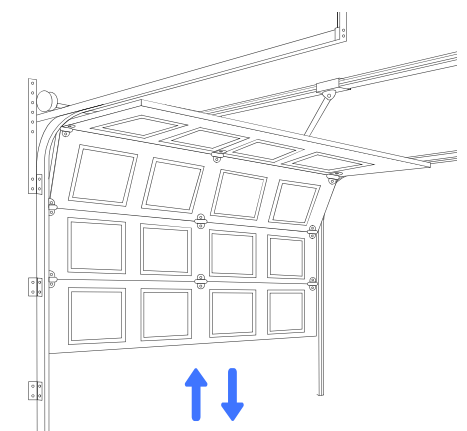

An audible & visual warning will activate for 5 seconds before the Konnected device triggers the garage door to close. This is a required safety feature and cannot be disabled.

# STEP 2: Platform Setup

## Cloud Setup

via Connected App

Integration with SmartThings and Alexa is provided by the free Connected Cloud service. Use the Connected app to sign up for Connected Cloud.

## Get the App



## Configure the Device

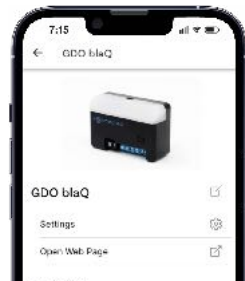

Tap **Settings** to configure your device for Connected Cloud.

Then follow the steps in the app to **update the device firmware**.

## SmartThings

In the SmartThings app, tap the + icon and **Add device > Partner device > By brand > Connected**

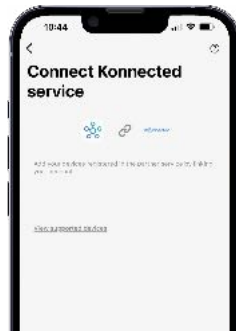

Follow the steps to link your Connected Cloud account to SmartThings

## amazon alexa

Install the **Connected skill for Alexa** from the Alexa Skills store.

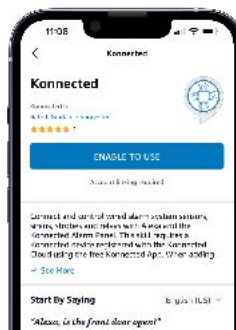

Follow the steps to link your Connected Cloud account to Alexa.

## Local Setup



After connecting your GDO to WiFi, Home Assistant should discover it automatically.

Open Home Assistant (mobile app or web interface) and look for **New devices discovered** in the Notifications pane.

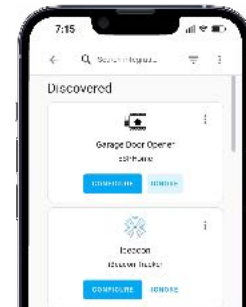
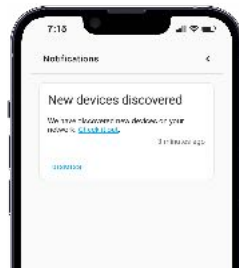

The GDO uses the built-in **ESPHome** integration. If it's not automatically discovered, go to **Settings > Devices & Services > Add Integration > ESPHome** to add it manually by IP address.

Now you can find the device named **Garage Door Opener** in **Settings > Devices & Services > Devices**.



The main control is the **Garage Door** entity. Tap **Add To Dashboard** for easy access.

## Customization

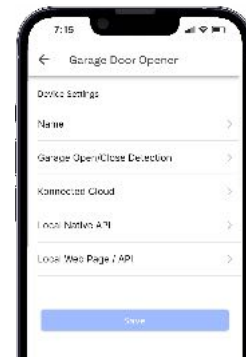

There are two ways to customize the settings of your new GDO.

Use the **Connected App** to customize and update your GDO firmware using our service that builds ESPHome configs for you!

Or, install the **ESPHome Dashboard** Add-on for Home Assistant and *adopt* your device.



Check our support site for ESPHome config tips.



## Local Setup



Install the driver for the Connected GDO blaQ using **Hubitat Package Manager**

Or download and import the *GarageDoorOpenerGDOv2Q.zip* file from our open-source drivers on GitHub: <https://github.com/konnected-io/konnected-hubitat/releases>

Next, in Hubitat go to **Devices > Add a device**. Then choose *Virtual*.

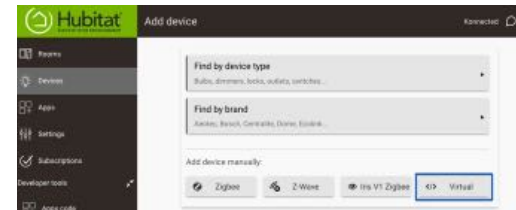

Fill in a **Device Name**. The **Device Network Id** should be auto-populated for you. Select **Connected Garage Door GDOv2-Q** from the **Type** drop-down. It will appear at the bottom of the drop-down under the **User** heading.

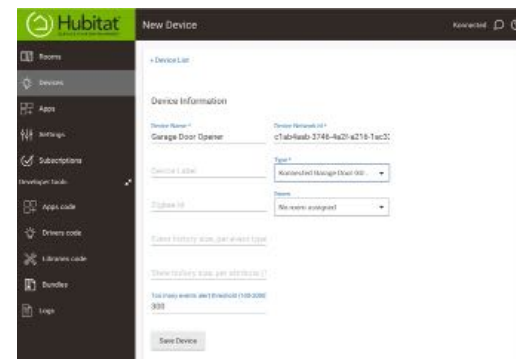

Find the **IP Address** of the device on your local network. You find this in the **Connected App**, or by looking in your router's app or for a device named **connected-XXXXXX**. Enter the IP address in the device's **Preferences** section and **Save Preferences**.

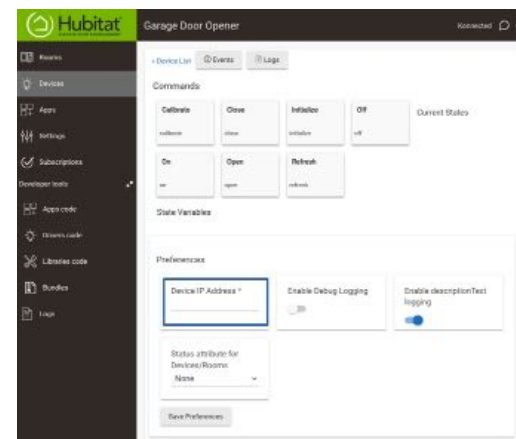

After saving the IP Address, Hubitat will connect to your device and automatically populate states! Your **Garage Door Opener** is ready to install and use.

### Statement Regarding FCC / IC Compliance

This device complies with part 15 of the FCC Rules. Operation is subject to the following two conditions: (1) this device may not cause harmful interference, and (2) this device must accept any interference received, including interference that may cause undesired operation.

*L'émetteur/récepteur exempt de licence contenu dans le présent appareil est conforme aux CNR d'Innovation, Sciences et Développement économique Canada applicables aux appareils radio exempts de licence. L'exploitation est autorisée aux deux conditions suivantes : (1) L'appareil ne doit pas produire de brouillage; (2) L'appareil doit accepter tout brouillage radioélectrique subi, même si le brouillage est susceptible d'en compromettre le fonctionnement.*

This equipment has been tested and found to comply with the limits for a Class B digital device, pursuant to part 15 of the FCC Rules. These limits are designed to provide reasonable protection against harmful interference in a residential installation. This equipment generates, uses, and can radiate radio frequency energy and, if not installed and used in accordance with the instructions, may cause harmful interference to radio communications. However, there is no guarantee that interference will not occur in a particular installation.

If this equipment does cause harmful interference to radio or television reception, which can be determined by turning the equipment off and on, the user is encouraged to try to correct the interference by one or more of the following measures:

- Reorient or relocate the receiving antenna.
- Increase the separation between the equipment and receiver.
- Connect the equipment to an outlet on a circuit different from that to which the receiver is connected.
- Consult the dealer or an experienced radio/TV technician for help.

Changes or modifications to this product not authorized by Connected could void the electromagnetic compatibility (EMC) and wireless compliance and negate your authority to operate the product.

**Exposure to radio frequency energy.** The radiated output power of this device meets the limits of FCC/IC radio frequency exposure limits. This device should be operated with a minimum separation distance of 20 cm (8 inches) between the equipment and a person's body.

Contains FCC ID: 2AC7Z-ESPS3MINI1  
Contains IC: 2AC7Z-ESPS3MINI1  
Connected MODEL: GDOv2-Q

### Limited Warranty

Connected warrants this product against defects in material or workmanship for a period of 1 year following the initial purchase and delivery of the product. However, Connected does not warrant that this product, when used together with software and/or services provided by Connected (collectively, "Products and Services") are defect- or error-free, or that the operation of the Products and Services will be uninterrupted or 100% available. The Products and Services rely in part on factors outside Connected's control, including the transmission of data through your Wi-Fi network, third-party cloud services, third-party open source software packages, self-hosted smart home controllers, mobile devices, and internet access. These factors may result in the Products and Services being unreliable or unavailable. Connected does not warrant that the products and services will meet all of your requirements or be compatible with your equipment. Except as expressly stated in this section, to the maximum extent permitted under applicable law, Connected is providing and licensing the Products and Services as is without warranty of any kind, either express or implied, including, but not limited to, the implied warranties of merchantability, title, non-infringement, and fitness for a particular purpose.

### Limitation of Liability

This device enables an end-user to monitor and control their garage door or motorized gate remotely over an IP network and/or the internet via a mobile app provided by Connected and/or 3rd party smart home platform or app and/or a device API. You accept that risks are associated with this and that you and/or the end-user will bear all the risks related to using Connected Products & Services. Connected, its directors, officers, agents, partners, and licensors shall not be liable to you or the end-user for any loss or damage of any kind, including but not limited to personal or bodily injury (including death or disability) or property damage resulting from the use of these Products and Services. To the maximum extent permitted by applicable law, in no event will Connected, its directors, officers, agents, suppliers, and licensors be liable to the user (whether in contract, tort (including negligence) or otherwise) for any indirect, incidental, consequential, special, punitive, or exemplary damages, including without limitation lost profits, lost business opportunities, loss of use of the service offering, loss of goodwill, business interruption, loss of data, lost savings, or other economic damage, arising out of this agreement or the use or inability to use the device, software or documentation, even if Connected or a dealer authorized by Connected had been advised of the possibility of such damages.

### Privacy

Connected values your privacy and we give you options to use our products without providing any personal information. Connected Cloud is an optional cloud service that connects your device to third-party smart home platforms. To use Connected cloud you must provide basic personal information so that we can identify your account. You can use this product without providing any personal information by opting to use local platform integrations that do not require a Connected Cloud account.

### Terms of Use and Privacy Policy

Your use of the Products and Services is governed by Connected's Terms of Use and Privacy Policy, located at [connected.io/terms](https://connected.io/terms) and [connected.io/privacy](https://connected.io/privacy).

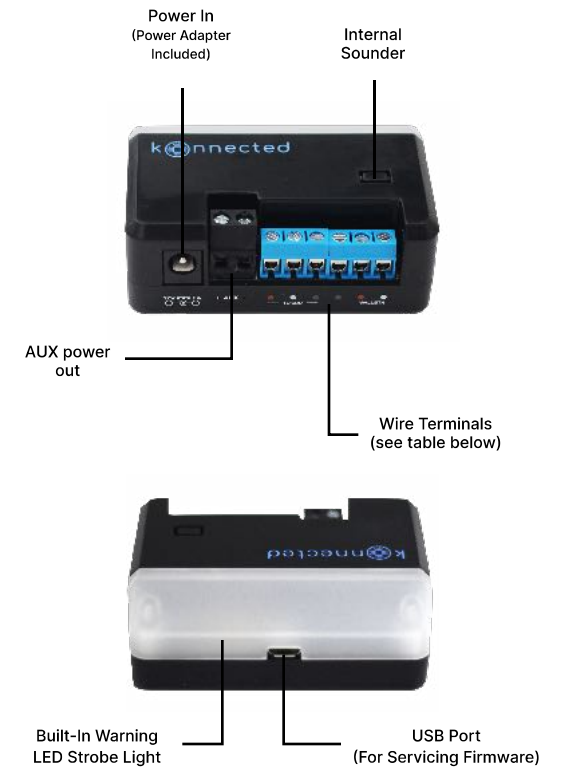

Input voltage	5-24 VDC (12V recommended)
AUX output voltage	Same as input (pass-through)
Red	Garage opener Security+ 1.0/2.0 communication serial bus
White	Ground / common
Gray	INPUT. Can be used for additional contact sensor, motion sensor, etc.
USB port	Micro-USB connector

Security+, Security+ 2.0, Chamberlain, myQ and LiftMaster are registered trademarks of The Chamberlain Group, Inc.

CRAFTSMAN is a registered trademark of Stanley Black & Decker, Inc.

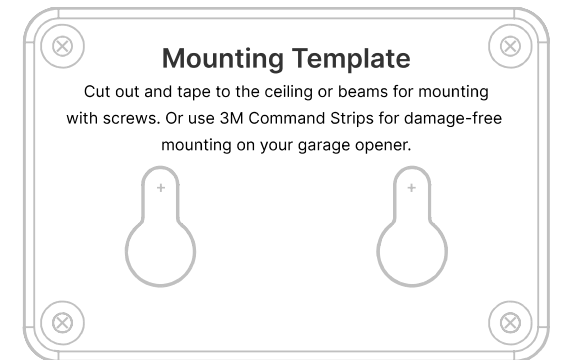

- https://support.konnected.io
- help@konnected.io
- https://community.konnected.io

