

EAS

EXPANDABLE ACCESSORY SYSTEM



INSTALLATION GUIDE

Table of Contents

4	Read Me
4	Important Information
4	Safety Terms
5	At a Glance
5	EAS (Expandable Accessory System)
6	Main Cable Connections
6	Securing the EAS
7	Routing the Main EAS Cable
7	Connecting EAS Accessories
8	JAB (Juice Attitude Bridge)
8	Juice to Attitude Connections
9	EGT (Exhaust Gas Temperature)
9	Exhaust Gas Temperature (EGT) Sensor Connections
11	Non-Expandable EGT
12	SOTF (Shift On The Fly)
12	2011-2014 Ford 6.7L
13	2015-2017 Ford 6.7L
14	2010-2018 Dodge/Ram 6.7L
15	2001-2004 GM 6.6L LB7
16	2004.5-2005 GM 6.6L LLY
17	2006-2007 GM 6.6L LBZ
18	2007.5-2010 GM LMM
19	2011-2016 GM 6.6L LML
20	Universal Sensor Input
20	Applications
20	Drilling and Tapping
21	Temperature Sensor Installation
22	Pressure Sensor Installation
23	Generic Sensor Installation
24	Turbo Cool Down
24	Fuse Box Locations
24	Installing the Fuse Adapter
26	Generic Installations
27	Dodge Adapter Installation

28 Power Switch

28 Connections

29 Monitoring Tools with Power Switch - Device 1

31 Monitoring Tools with Power Switch - Device 2

32 Monitoring Tools with Power Switch - Device 3

33 EAS 12V Power

33 Connecting to Power

34 MyStyle

34 Starting MyStyle

35 Universal Sensor Input - Explained

36 Universal Sensor Input - Custom Mapping

38 EGT Sensor

38 Display Setup

39 Power Switch

Read Me

Important Information

Before using your new EAS device, it is important that you update your product. Refer to the Display Device's User Guide for more information on how to use the Fusion update software, or visit our web site.

Please take the time to thoroughly review all of the information outlined in this guide. Taking the time to understand how this product works and how to properly operate it will ensure that you have an extraordinary and safe driving experience. If we can be of any assistance to help you get the most from your product please call us.

Thank you again for your business and enjoy your new product.

IMPORTANT: Read through these instructions completely so that you understand each step prior to installation. Refer to the Display Device User Manual for Safety and Warranty info.

Safety Terms

Throughout this guide (hereafter noted as User Manual or Manual) you will see important messages regarding your safety or the protection of your vehicle. These messages are designated by the words WARNING or CAUTION.

! WARNING indicates a condition that may cause serious injury or death to you, your passengers or others nearby. Pay careful attention to these Warning messages, and always comply with them. They could save a life.

CAUTION indicates a condition that could cause damage to your vehicle. It is important to install and operate your product in conformance with instructions in this Manual. Caution alerts you to particularly important things that will keep your vehicle operating properly.

At a Glance

EAS (Expandable Accessory System)

The EAS system was designed with ease of installation in mind. The system itself is installed under the hood with only one cable that has to be routed through the firewall.

EGT Probe- Exhaust Gas Temperature probe can be used to monitor engine temperatures during normal and extreme driving conditions.

Main EAS Cable

Connects the EAS accessories to the main device cable

JAB Adapter
The Juice to Attitude Bridge allows you to connect your Edge Juice Module to your Attitude Monitor.

SOTF
The Shift On The Fly gives you the ability to change levels in place of a DSP switch.

Turbo Timer

This accessory keeps the engine running, when the vehicle has been parked, and allows the engine to properly cool down before it is shut off.

Power Switch

This accessory gives you the ability to control two separate devices using your Display.

Universal (5V) Sensor

This accessory gives you the ability to monitor a variety of sensor output readings using your display.



End Cap

Used to terminate the communication lines.

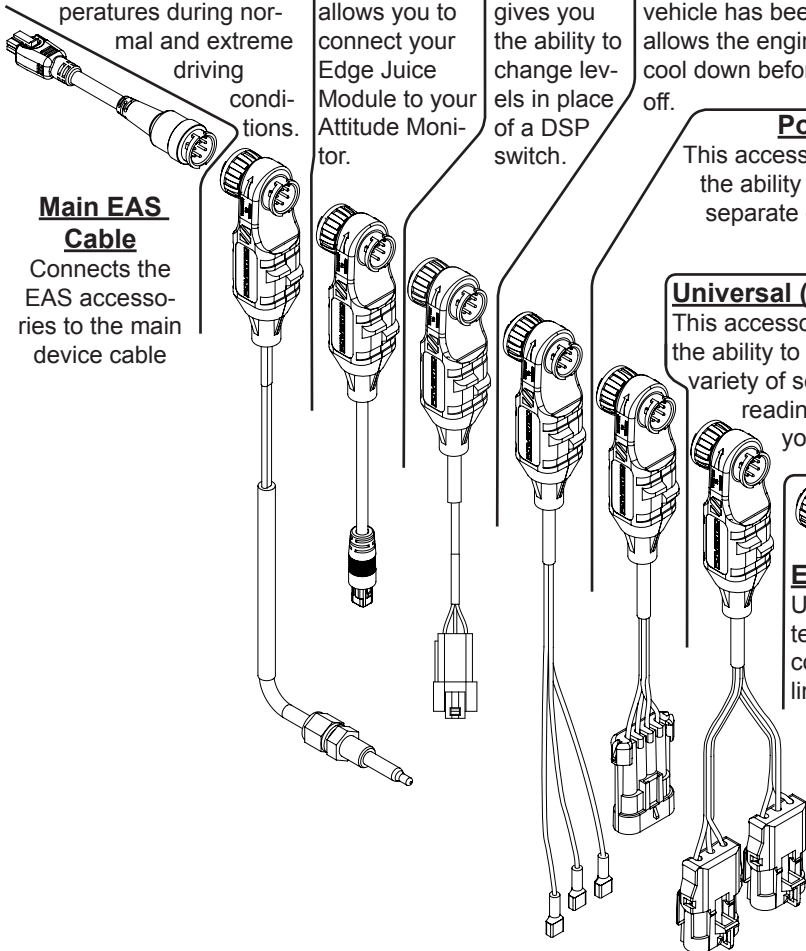

NOTE: The HDMI to OBDII cable is included with your display device (i.e Insight, Evolution, or Attitude). Please refer to the display's installation guide for more information on how and where to install it.

Main Cable Connections

Securing the EAS

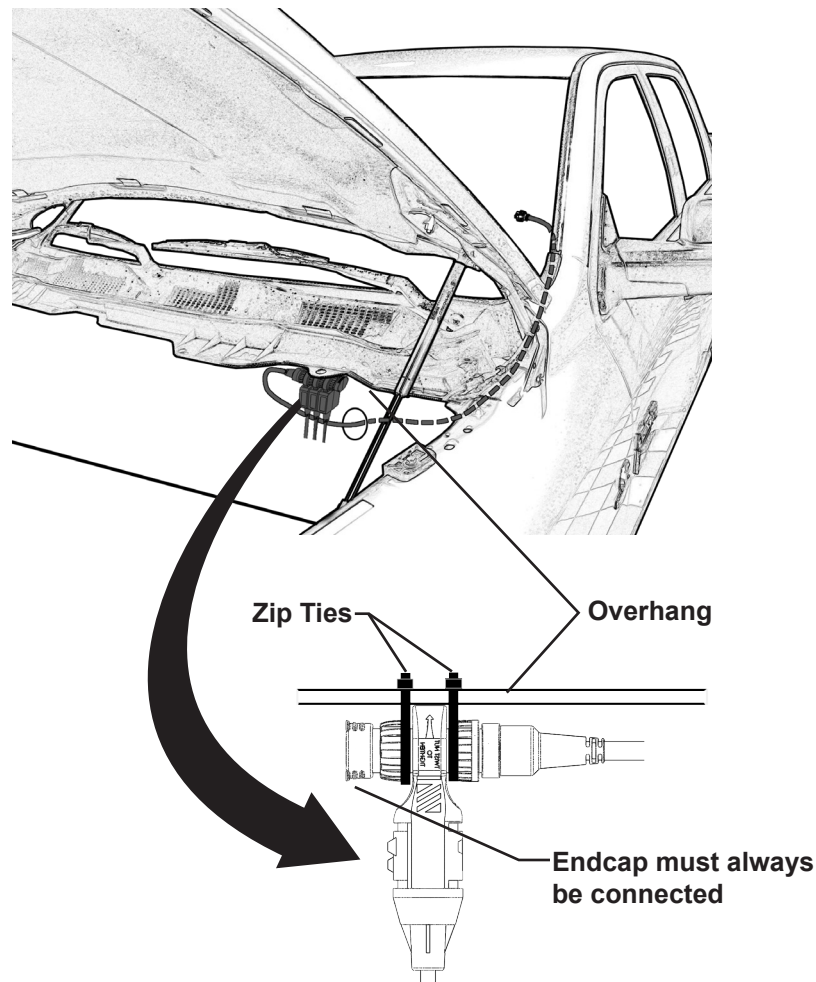

STEP 1 - Using the supplied zip ties, fasten the EAS connectors underneath the overhang which runs across the top of the fire wall. Keep the EAS assembly close to the driver side.

STEP 2 - Use any remaining zip ties to secure loose cable.

NOTE: *If more than one EAS device is plugged together, use the long zip ties provided in the packet to connect their bodies together.*

Routing the Main EAS Cable

STEP 1 - Locate an entry point from underneath the hood and into the cab.

TIP - Most vehicles will have a rubber or plastic plug that can be removed from the firewall. Other vehicles may already have cables or wire harnesses going through it.

STEP 2 - Route the rectangular (6 pin) connector from underneath the hood and into the cab. Leave the round connector under the hood.

CAUTION: Be careful not to damage the connector and/or its locking mechanism during installation.

STEP 3 - Plug the Main EAS Cable into the HDMI cable junction.

STEP 4 - Make sure this junction is free from moving vehicle components (e.g. brake pedal, gas pedal, steering column, etc)

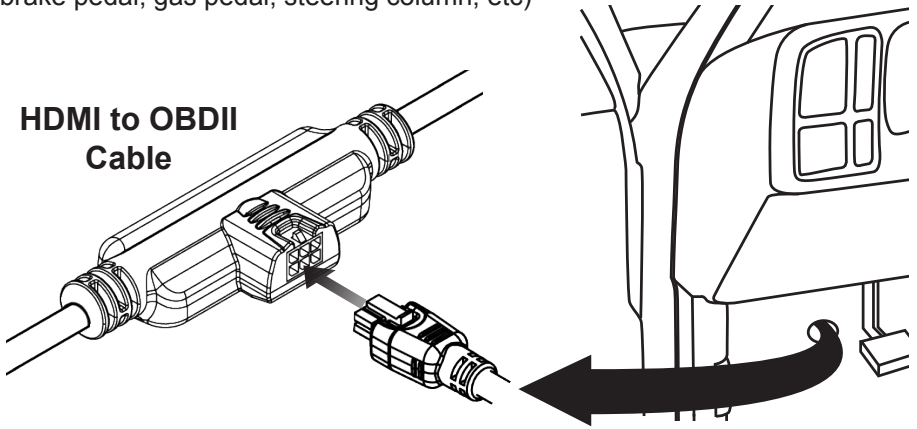

Connecting EAS Accessories

The round EAS connectors are Keyed which means that they can only be plugged in one way.

STEP 1 - Locate the two “key” features on each connector and lightly push the two together.

CAUTION: Be carefull not to damage the gold contacts during installation.

STEP 2 - While lightly pushing the two connectors together, twist the nut until you feel the tabs snap/lock into place.

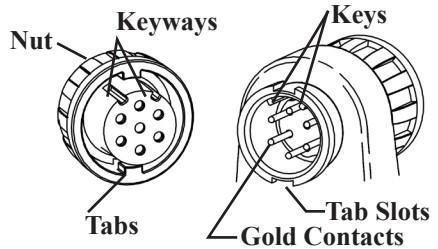

JAB (Juice Attitude Bridge)

Juice to Attitude Connections

NOTE: The Juice Harness is included in your Juice module packaging. Please refer to the Juice Installation Manual for more information on how and where to install it.

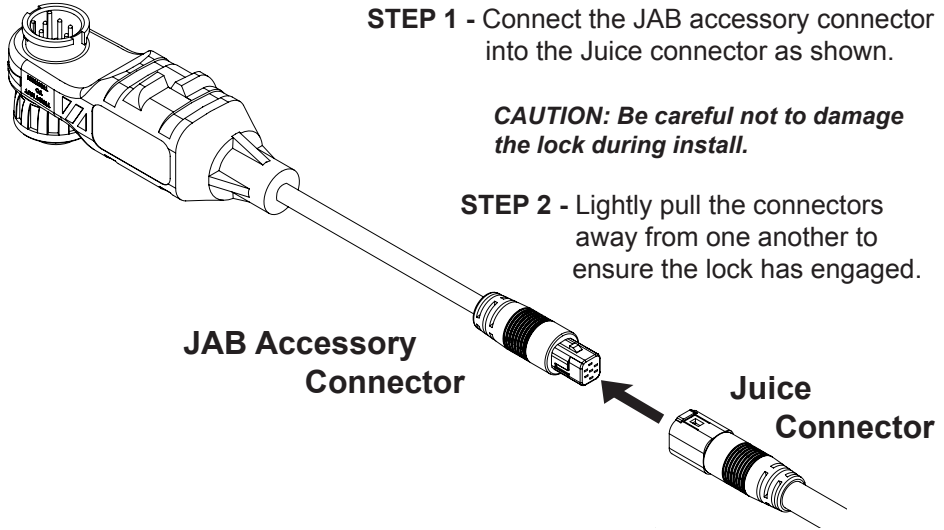

If for some reason you need to un plug this connection, please refer to the following instructions:

STEP 1 - Using a small, flat head screw driver, lightly disengage the latch on top of the connector as shown. Be careful not to bend it too far to avoid it breaking off.

STEP 2 - Lightly pull the two connectors apart to disengage the connection.

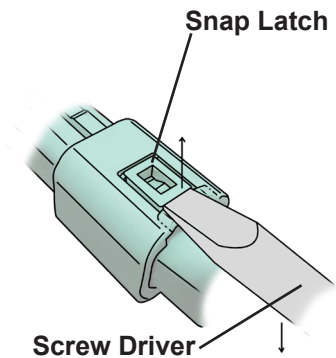

EGT (Exhaust Gas Temperature)

Exhaust Gas Temperature (EGT) Sensor Connections

⚠ WARNING When installing the EGT sensor, wear eye protection and protective clothing to protect from getting metal chips in your eyes and skin. Also, since exhaust manifolds can be very hot, allow the engine to cool before drilling. When working under the vehicle, make sure the parking brake is set.

CAUTION: One effective way to avoid metal fragment contamination in your engine manifold is to apply grease in the tip of the drill bit and threads of your tap tool when drilling/tapping the hole in your manifold. Reduce pressure on the drill when the drill breaks through the manifold wall to reduce risk of pushing metal chips into the manifold.

Required Tools

- Drill
- 1/8" drill bit (pilot hole)
- 21/64" (best size) or 5/16" drill bit
- 9/16" wrench or socket
- 5/8" open end wrench
- 1/8"-27 NPT Thread Tap
- Phillips screwdriver
- 5/16" or 8mm wrench

STEP 1 - Drill a 21/64" (5/16" optional) hole through the exhaust manifold wall.

STEP 2 - Use a 1/8" National Pipe Tap (NPT) to cut threads into the hole drilled in STEP 1.

STEP 3 - Remove the fitting from the thermocouple end and install by the tapered thread end into the manifold. Tighten the fitting so that it is securely seated.

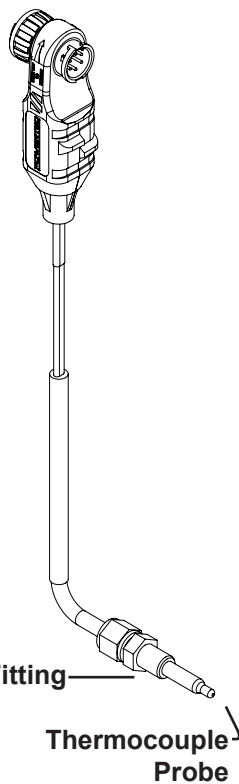

NOTE: Ideally the bottom of the fitting would be less than or flush with the inside of the manifold wall.

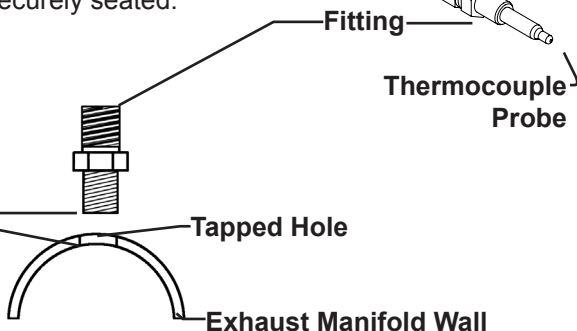

STEP 4 - Next, insert the thermocouple through the fitting and into the center of the manifold. Be careful not to damage the thermocouple tip.

STEP 5 - Tighten the top nut of the fitting just enough to keep the probe firmly mounted.

STEP 6 - Position the cable to allow for the least amount of bending when routing to the firewall.

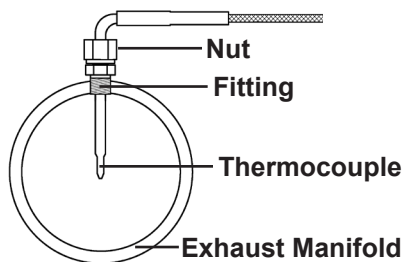

NOTE: The probe will move approximately 90 Deg. clockwise in the direction the nut is tightened.

STEP 7 - Before fully tightening the nut, make sure the cable starts 90 Degrees from the final resting position.

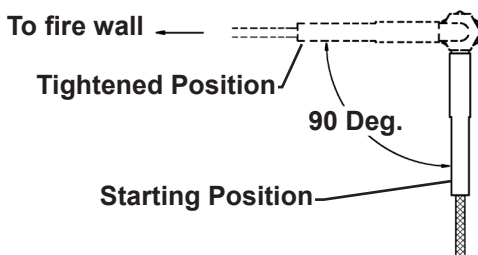

STEP 8 - Tighten the nut until snug and until the cable is in its final resting position.

CAUTION: Do not bend the probe after installed. If needed, loosen the probe nut, adjust the probe, and re-tighten. Bending the probe tubing will result in a faulty probe.

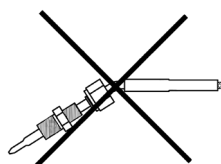
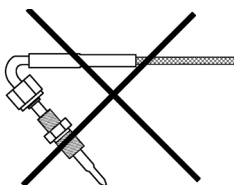
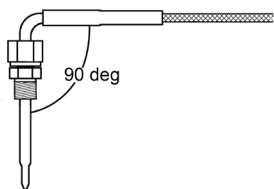

Non-Expandable EGT

The non-expandable accessory system (Standard EGT Probe) provides a single sensor allowing the user to monitor only one EGT parameter.

NOTE: *The EGT sensor can not be chained and if you wish to add expandable capability, you will need to purchase a new expandable EGT.*

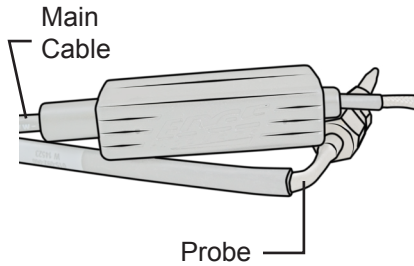

SOTF (Shift On The Fly)

2011-2014 Ford 6.7L

STEP 1 - Disconnect the factory harness from the fuel temperature sensor.

CAUTION: *Be careful not to damage the lock.*

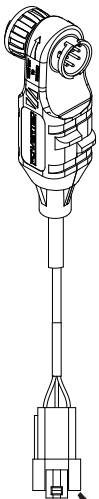
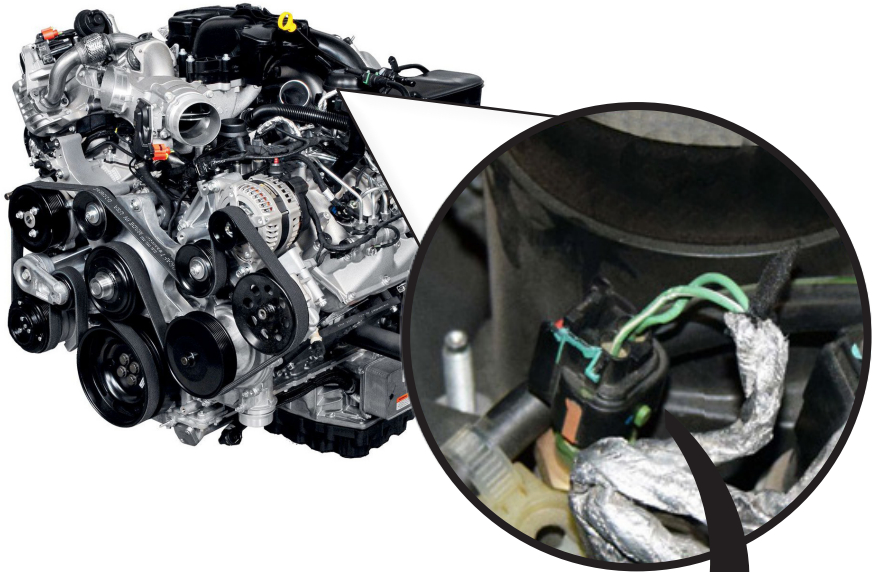

STEP 2 - Connect the supplied cable to the factory harness.

CAUTION: *Be careful not to damage the lock.*

STEP 3 - Connect the supplied cable to the SOTF and secure the harness and cable in the engine bay.

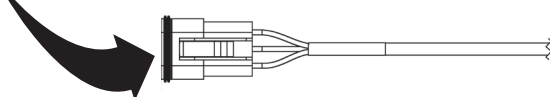
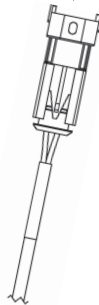

2015-2017 Ford 6.7L

STEP 1 - Disconnect the factory harness from the fuel temperature sensor.

CAUTION: *Be careful not to damage the lock.*

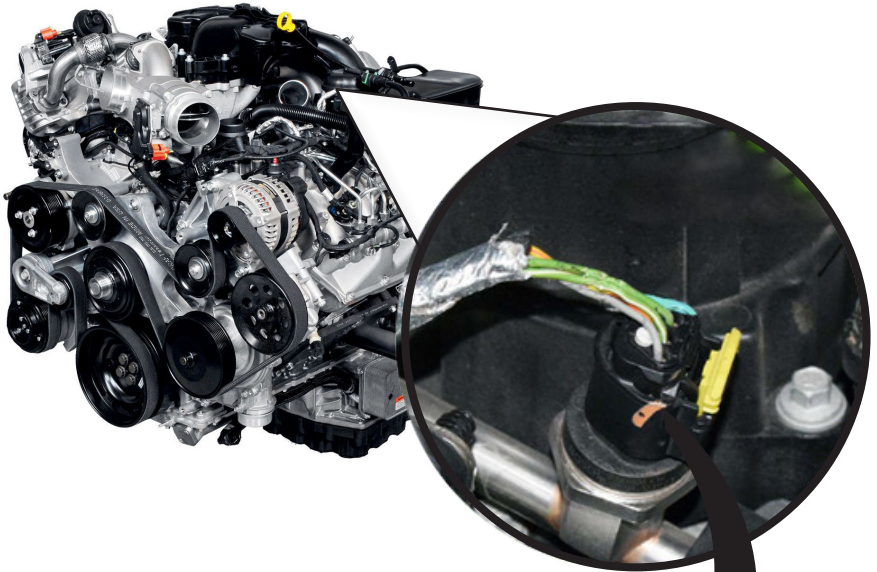

STEP 2 - Connect the supplied cable to the factory harness.

CAUTION: *Be careful not to damage the lock.*

STEP 3 - Connect the supplied cable to the SOTF and secure the harness and cable in the engine bay.

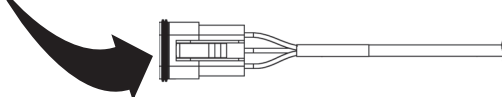
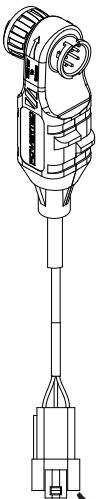

2010-2018 Dodge/Ram 6.7L

STEP 1 - Disconnect the factory harness from the crankcase pressure sensor. First slide the red locking tab back, before pressing the release tab and pulling the connector off.

CAUTION: *Be careful not to damage the lock.*

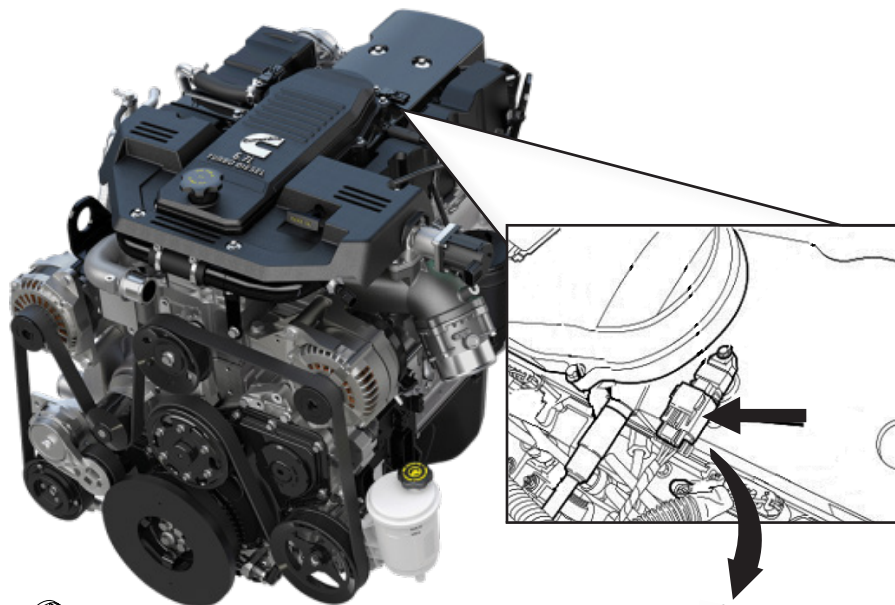

STEP 2 - Connect the supplied cable to the factory harness. Engage the lock by sliding the red locking tab in after sliding the connectors together.

CAUTION: *Be careful not to damage the lock.*

STEP 3 - Connect the supplied cable to the SOTF and secure the harness and cable in the engine bay.

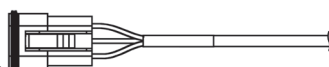
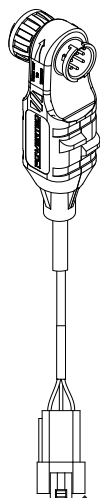
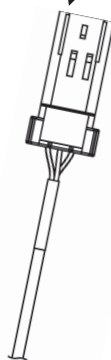

2001-2004 GM 6.6L LB7

NOTE: Professional Installation is recommended

STEP 1 - Carefully remove TCM cover, and lift out and disconnect TCM.

STEP 2 - Locate the ECM, and carefully remove ECM cover.

STEP 3 - Use a 7mm wrench or socket and ratchet to loosen the blue connector's bolt.

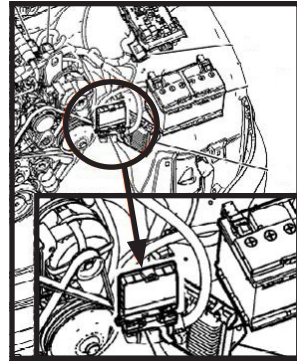

STEP 4 - Disconnect the blue connector and remove the blue covers, exposing the pins.

STEP 5 - Locate pin holes #49 and #69 as seen below.

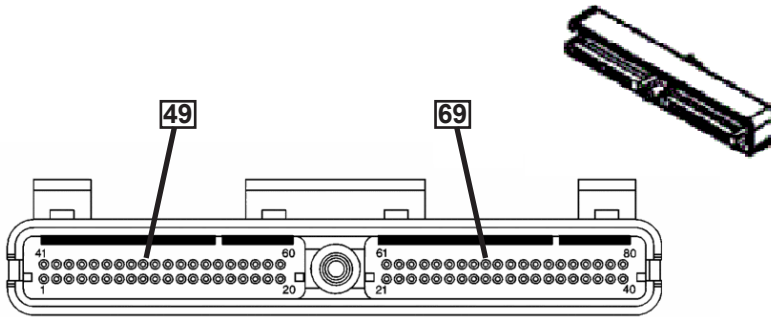

STEP 6 - Install the white lead from the supplied cable into pin hole #69, and the black lead into pin hole #49. Make sure to install the pins in the connector so they are flush with the other pins in the connector.

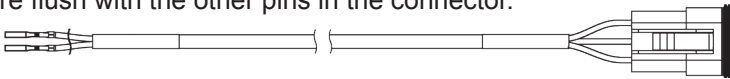

STEP 7 - Replace the blue cover and reconnect the blue connector.

STEP 8 - Tighten the connector bolt until snug, and then replace the black cover.

STEP 9 - Replace the TCM and TCM cover, and reclip it into place.

STEP 10 - Connect the supplied cable to the SOTF and secure the harness and cable in the engine bay.

2004.5-2005 GM 6.6L LLY

NOTE: Professional Installation is recommended

STEP 1 - Locate ECM near the front of the engine bay, next to the battery.

STEP 2 - Lift the grey lever on the grey connector (J3) and detach the plug. (Push in the tab to allow the lever to slide up).

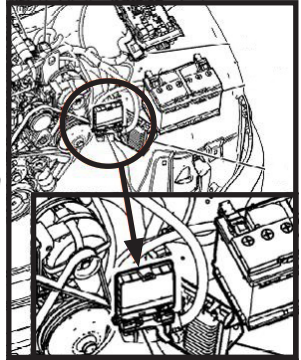

STEP 3 - Remove the black cover from the connector to expose the wire input side of the connector.

STEP 4 - Remove the green pin lock using long nose pliers, being careful not to damage or misplace it.

STEP 5 - Locate pin holes #32 and #50, and using long nose pliers carefully remove the filler pins.

STEP 6 - Install the white lead from the supplied cable into pin hole #32, and the black lead into pin hole #50. Make sure to install the pins in the connector so they are flush with the other pins in the connector.

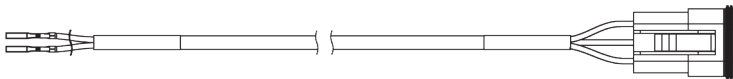
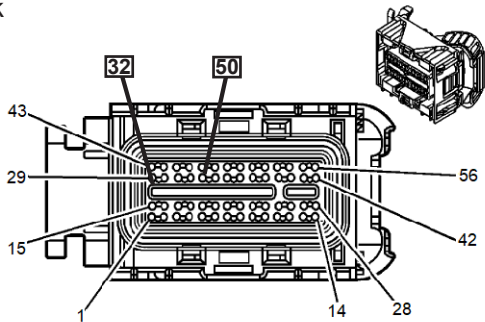

STEP 7 - Reinstall the green pin lock and make sure the orange grommet inside the connector is still in place. Replace the black cover.

STEP 8 - Reconnect the grey connector, and ensure the lever is closed completely.

NOTE: If the lever will not close, disconnect the connector and clean any dirt or debris and try again.

STEP 9 - Connect the supplied cable to the SOTF and secure the harness and cable in the engine bay.

2006-2007 GM 6.6L LBZ

NOTE: Professional Installation is recommended

STEP 1 - Locate ECM near the front of the engine bay.

STEP 2 - Lift the black lever on the smaller connector until the connector is released from the ECM, then do the same for the larger connector.

STEP 3 - Remove the black cover on the larger connector by using a thin flat head screwdriver to dislodge the containing tabs.

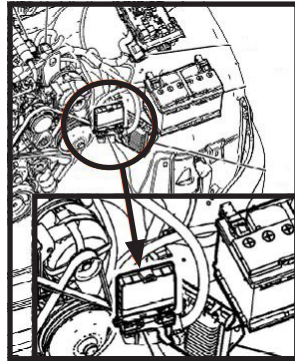
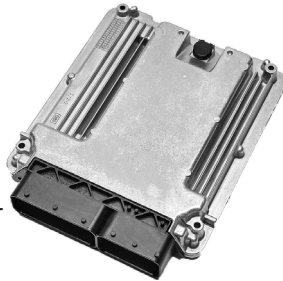

STEP 4 - Remove the pink pin lock from the connector using a flat head screwdriver, being careful not to damage or misplace it.

STEP 5 - Locate pin holes #46 and #54; and install the white lead from the supplied cable into pin hole #46, and the black lead into pin hole #54. Make sure to install the pins in the connector so they are flush with the other pins in the connector.

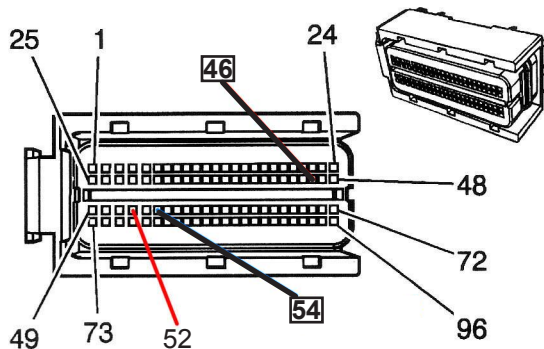

STEP 6 - Carefully reinstall the pink pin lock into the connector.

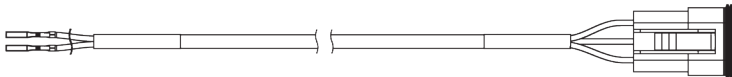

STEP 7 - Replace the larger connector onto the ECM and gently push the connector into place, and close the lever until it closes against the ECM. Do the same with the smaller connector until both connectors are replaced.

NOTE: If the lever will not close, disconnect the connector and clean any dirt or debris and try again.

STEP 8 - Connect the supplied cable to the SOTF and secure the harness and cable in the engine bay.

2007.5-2010 GM 6.6L LMM

NOTE: Professional Installation is recommended

STEP 1 - Locate ECM near the front of the engine bay.

STEP 2 - Lift the black lever on the smaller connector until the connector is released from the ECM, then do the same for the larger connector.

STEP 3 - Remove the black cover on the larger connector by using a thin flat head screwdriver to dislodge the containing tabs.

STEP 4 - Remove the pink pin lock from the connector using a flat head screwdriver, being careful not to damage or misplace it.

STEP 5 - Locate pin holes #46 and #54; and install the white lead from the supplied cable into pin hole #46, and the black lead into pin hole #54. Make sure to install the pins in the connector so they are flush with the other pins in the connector.

STEP 6 - Carefully reinstall the pink pin lock into the connector.

STEP 7 - Replace the larger connector onto the ECM and gently push the connector into place, and close the lever until it closes against the ECM. Do the same with the smaller connector until both connectors are replaced.

NOTE: If the lever will not close, disconnect the connector and clean any dirt or debris and try again.

STEP 8 - Connect the supplied cable to the SOTF and secure the harness and cable in the engine bay.

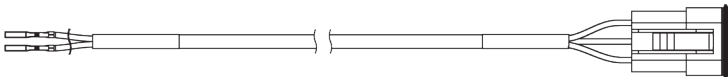
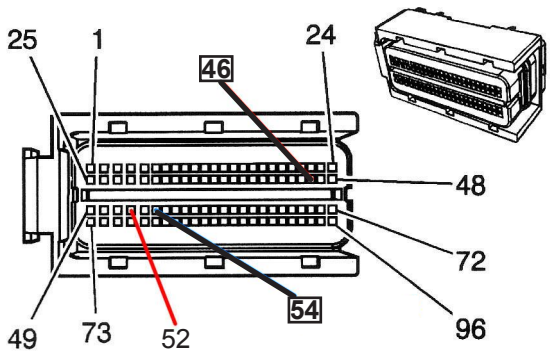
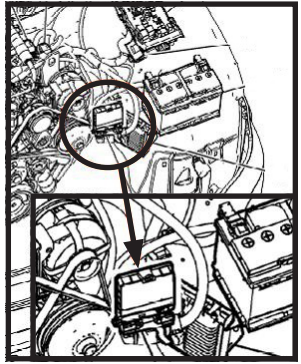

2011-2016 GM 6.6L LML

NOTE: Professional Installation is recommended

STEP 1 - Remove the plastic protection cover over the ECM.

STEP 2 - Disconnect the ECM plug closest to the fire wall (J3 Gray Plug).

STEP 3 - Remove the zip tie holding the top cover and remove the cap by lifting the 2 ears on either side.

STEP 4 - Remove/pry the Gray ECM connector cover off of the connector with a flathead screwdriver.

CAUTION: Be careful not to damage the cover.

STEP 5 - Locate pin holes #11 & #35 (On 2011 trucks pin #11 will have a yellow pin that needs to be released with a tool). Remove the plastic filler pins from #11 & #35 by using a 1/16 drill bit and pushing the pin out the top with the flat end of the bit.

CAUTION: Be careful not to damage the connector.

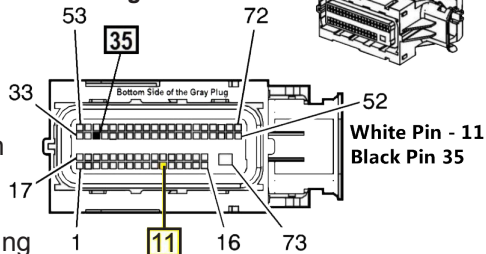

STEP 6 - Install the white lead from the supplied cable into pin #11 and the black lead into pin #35. Make sure to install the pins in the connector so they are flush with the other pins in the connector.

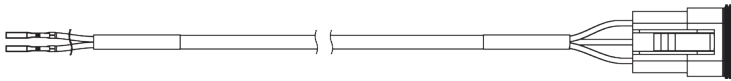

STEP 7 - Reinstall the grey connector cover back in the plug

STEP 8 - Reinstall the cap back on the plug and apply a zip tie where the original factory zip tie was.

STEP 9 - Reinstall the connector into ECM and reinstall the ECM protection cover

STEP 10 - Connect the supplied cable to the SOTF and secure the harness and cable in the engine bay.

Universal Sensor Input

Applications

This accessory allows you to connect up to two sensors at one time. However, if an additional accessory is purchased, you can “Daisy Chain” them to read multiple sensors at once.

The two most common sensors are temperature sensors (i.e thermistors) and pressure sensors. We offer these two types in easy to install kits that are described in the following three sections. Other types of sensors may also be connected using the 8 ft long adapters supplied with each Universal Sensor Kit. How these adapters are used will be explained in more detail later in the Universal Sensor Installation section.

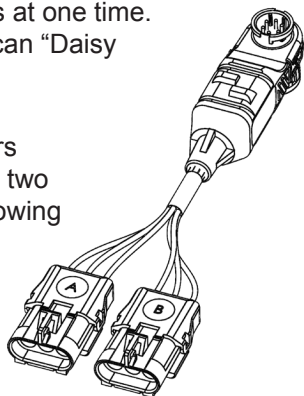

Drilling and Tapping

These drilling and tapping instructions are generic for any install. However, you may need different drill bit sizes or additional tools for sensors we do not offer.

REQUIRED TOOLS:

- Drill
- 1/8"-27 NPT Thread Tap
- Thread Sealing Compound
- 21/64" Drill bit
- 3/8" socket/wrench (temp sensor)
- 1/2" socket/wrench (temp sensor)
- 13mm Drill bit (pressure sensor)

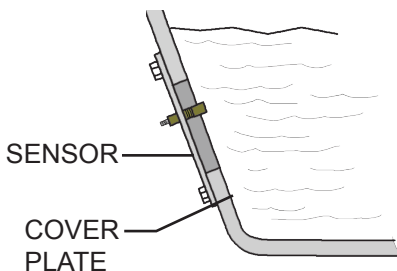

STEP 1 - Find the best location for the sensor to reside. The wall thickness of the object you are drilling needs to be able to properly capture the sensor's threads.

NOTE: *The example shows the temperature sensor being installed to the side plate of a manual transmission. This location is ideal for this particular install because the plate can easily be removed, modified, and reinstalled.*

STEP 2 - Use the 21/64" drill bit to drill a hole perpendicular to the face you are drilling into.

STEP 3 - Tap the hole using the 1/8" NPT pipe tap.

STEP 4 - Clean the area in and around the tapped hole and make sure it is free of burrs and metal fragments.

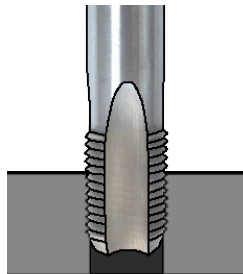

Temperature Sensor Installation

If you have purchased our Temperature Sensor kit, please follow these instructions:

STEP 1 - Use the 1/2" wrench to tighten until snug. Do not over tighten to avoid stripping out threads.

STEP 2 - Locate the Temperature Adapter Harness included with the sensor.

STEP 3 - Remove the hardware from the end of the mounted sensor.

STEP 4 - Re-install the hardware, including the adapter's ring terminal, in the order shown below.

STEP 5 - Tighten the nut using the 3/8" wrench or socket (Do not over tighten).

STEP 6 - Route the remaining connector and wire to the Universal Sensor accessory.

STEP 7 - Plug the adapter connector into one of the accessory connectors.

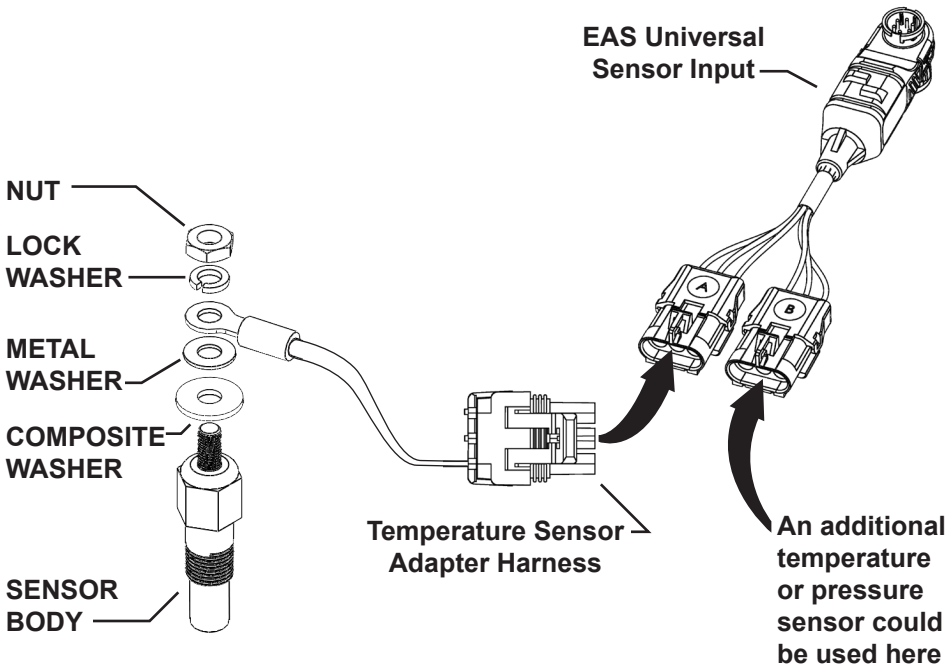

Pressure Sensor Installation

If you have purchased our Pressure Sensor kit, please follow these instructions:

STEP 1 - Apply a thread sealing compound to the sensor threads and insert it into the tapped hole. (This is especially important if there is potential for leaking)

STEP 2 - Use the 13mm wrench to tighten until snug. Do not over tighten to avoid stripping out threads.

STEP 3 - Locate the Pressure Sensor Adapter Harness included with the sensor.

STEP 4 - Plug the small round connector into the pressure sensor.

STEP 5 - Route the remaining connector and wire to the Universal Sensor Input.

STEP 6 - Plug the adapter connector into one of the accessory connectors.

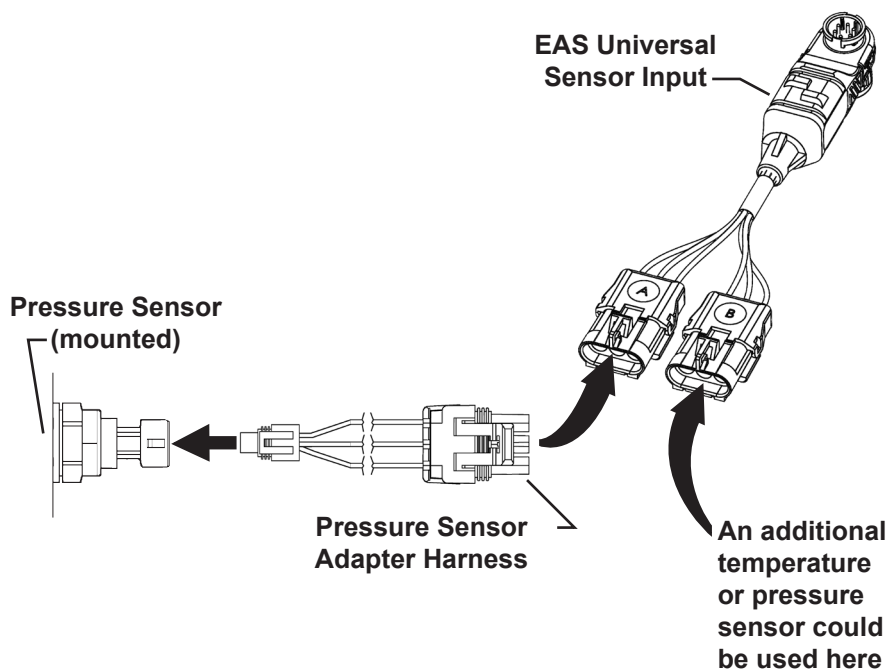

Generic Sensor Installation

If you have purchased the Universal Sensor Input accessory, with the intent of connecting a sensor we didn't supply you, please follow these instructions.

There are 3 basic types of sensors. The sensor you plan on using may come with 1, 2, or 3 connections that are required for it to function. Determine what your sensor requires, and follow the instructions accordingly.

STEP 1 - Find the best location for the sensor to be installed.

STEP 2 - Follow the instructions provided with your sensor and install it accordingly.

STEP 3 - Use the appropriate wires on one of the generic adapters we have provided and connect them to your sensor according to the wire color.

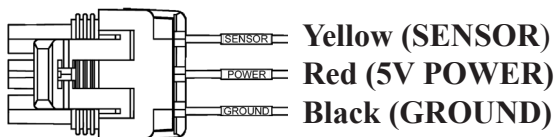

NOTE: You may have noticed that there is a sticker on each of the Universal Sensor Connectors. The letters on the stickers, either A or B lets you know which sensor you have plugged into. Do not remove them. Refer to the Mystyle section of this manual for more information on how these letters are used.

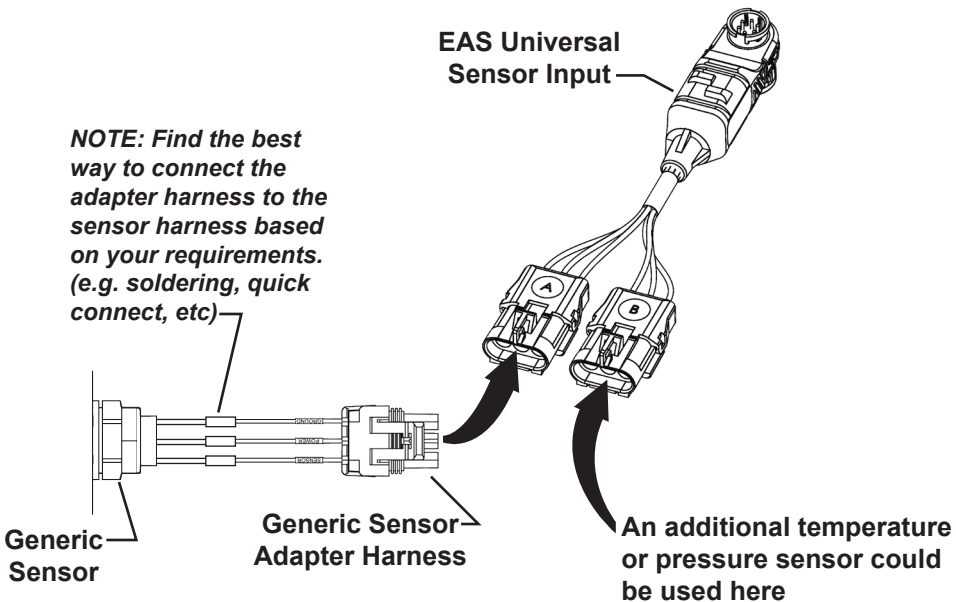

Turbo Cool Down

Fuse Box Locations

There are 3 possible fuse box locations:

Under the Hood

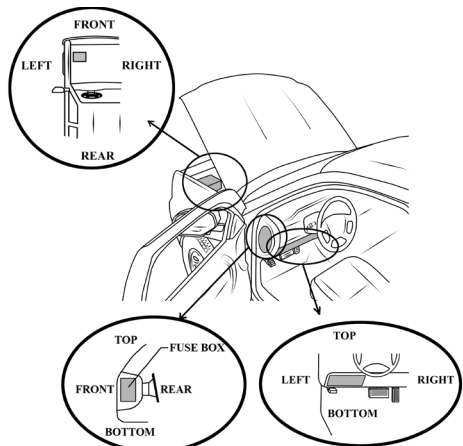

Behind Side Panel

Below Steering Column

Each fuse adapter needs to be oriented within the fuse box in a specific way. The side of the fuse with the wire coming out will be inserted into the "Hot" side of the fuse location. These locations are listed in the following tables under the Orientation column as Top, Bottom, Front, Right, etc.

Fuse Adapter



Plug into Hot side of fuse location

Installing the Fuse Adapter

Each connection on the EAS accessory is labeled according to the wire color: Yellow(VBAT), Red(IGN), & White(RUN). Use the following tables to locate the fuse location.

Repeat these steps for all three wire colors:

STEP 1 - Search for your make and model in the list provided.

STEP 2 - Locate the fuse box as indicated and shown above.

STEP 3 - Locate the vehicle fuse and remove it.

STEP 4 - Insert the correct fuse adapter, into the fuse box, according to the amp value and the orientation indicated.

STEP 5 - Connect the correct colored wire to the installed fuse adapter using the quick-connects.

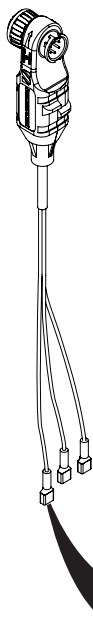

NOTE: The following (3) tables have information for specific vehicles. If you do not see your vehicle here, refer to the Generic Installation section.

TABLE 1 - VBAT (Yellow Wire)

TRUCK YEAR	FUSE BOX	FUSE (amps)	ORIENTATION
GM			
2001-2002	Under Hood	TBC (10amp)	Rear
2003-2007	Under Hood	TBC BATT (10amp)	Rear
2007.5-2014	Under Hood	IPC (10amp)	Rear
2015-2018	Under Hood	53 (10amp)	Rear
FORD			
1994-1997	Steering Column	16 (15amp)	Bottom
1999-2001	Steering Column	4 (10amp)	Left
2002-2003	Steering Column	10 (10amp)	Left
2004-2007	Steering Column	2 (10amp)	Left
2008-2010	Under Hood	30 (10amp)	Front
2011-2016	Under Hood	46 (10amp)	Left
2017-2018	Under Hood	95(10amp)	Left
DODGE			
1998.5-2002	Under Hood	A/C CLUTCH (10amp)	Front
2003-2005	Under Hood	16 (10amp)	Rear
2006-2009	Under Hood	23 (10amp)	Left
2010	Under Hood	M26 (10amp)	Front
2011-2012	Under Hood	M27 (10amp)	Right
2013-2018	Under Hood	44 (10amp)	Right

TABLE 2 - IGN (Red Wire)

TRUCK YEAR	FUSE BOX	FUSE(amps)	ORIENTATION
GM			
2001-2007	Under Hood	IGN E (10amp)	Rear
2007.5-2014	Under Hood	MISC ING (10amp)	Rear
2015-2018	Under Hood	39 (10amp)	Left
FORD			
1994-1997	Steering Column	17 (10amp)	Top
1999-2001	Steering Column	19 (10amp)	Right
2002-2007	Steering Column	45 (10amp)	Bottom
2008-2010	Under Hood	77 (10amp)	Front
2011-2016	Under Hood	52 (10amp)	Left
2017-2018	Under Hood	33 (10amp)	Left
DODGE			
1998.5-2002	Side Panel	9 (10amp)	Bottom
2003-2005	Under Hood	28 (10amp)	Front
2006-2012	Refer to "DODGE ADAPTER INSTALL" Section		
2013-2018	Under Hood	78 (10amp)	Rear

TABLE 3 - RUN (White Wire)

TRUCK YEAR	FUSE BOX	FUSE(#/NAME)	ORIENTATION
GM			
2001-2005	Side Panel	BRAKE (10amp)	Rear
2006-2007	Side Panel	BRK (10amp)	Rear
2007.5-2018	FUSE #3 Not needed for these trucks		
FORD			
1994-1997	Steering Column	18 (10amp)	Bottom
1999-2001	Steering Column	24 (10amp)	Left
2002-2003	Steering Column	26 (10amp)	Right
2003-2007	Steering Column	28 (10amp)	Right
2008-2018	FUSE #3 Not needed for these trucks		
DODGE			
1998.5-2002	FUSE #3 Not needed for these trucks		
2003-2005	Under Hood	35 (10amp)	Front
2006-2018	FUSE #3 Not needed for these trucks		
NOTE: On 2015 GM vehicles a check engine code (U0198) may be initiated when the turbo-timer is in use, but the check engine light will not turn on. The code can be cleared using the display device at any time.			

Generic Installations

For installation on vehicles not outlined previously:

VBAT CONNECTION

The YELLOW VBAT connector should be connected to constant battery power. This could be done by connecting to the battery itself or any fuse that has constant power.

IGN CONNECTION

The RED "IGN" connector needs to be connected to the RUN-START circuit of the vehicle. This circuit has power when the key is in the run position and in the start/crank position.

RUN CONNECTION

The WHITE "RUN" connector may or may not be necessary. The RUN connector is used to power modules that would otherwise generate codes if not powered while the turbo timer keeps the vehicle running. Typically these modules are connected to the RUN circuit of the vehicle. This circuit has power when the key is in the run position and only in the run position. **NOTE: If codes are set during or after using the turbo timer, the circuit that was touched with RUN is the wrong circuit.**

⚠ WARNING: DO NOT use fuse locations that are for the AIR BAG / Supplement Restraint System.

Dodge Adapter Installation

The 2006-2012 Dodge trucks require a “Y” style adapter that plugs in between the ignition module and the ignition harness. There are two types of adapters. Each is specific to a certain set of years:

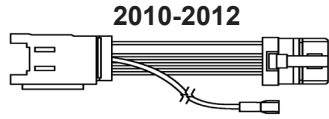
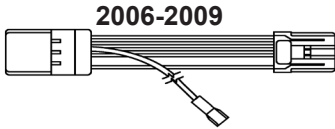

STEP 1 - Locate the key position connectors under the dash. The 2006-2009 connector is up and inside the steering column. The 2010-2012 connector is behind the key/ignition module.

STEP 2 - Unplug the factory harness and connect the adapter in between the truck connectors.

STEP 3 - Route the Red (IGN) wire from the Turbo Cool Down accessory through the firewall and up to the adapter.

STEP 4 - Connect the Red wire into the adapter pigtail using the quick connects.

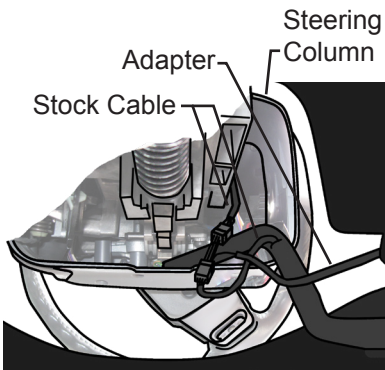

Looking up from brake pedal
(2006-2009)

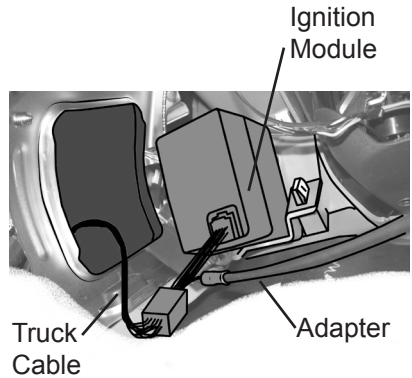

Looking up from brake pedal
(2010-2012)

Power Switch

Connections

A single EAS Power Switch gives you the ability to control two separate devices (e.g. light bars, spot lights, etc). Refer to the following instructions to learn how to properly connect a device to be controlled by an EAS Power Switch.

STEP 1 - Make sure the device(s) you are controlling came with an automotive grade relay. If not, you will need to purchase one.

TIP: You will need to make connections between the relays and each device you plan to control. We recommend using automotive quick disconnect style connectors that you can crimp onto the wires, and quickly install.

STEP 2 - Using the schematic below, make the proper connection to the load (what you are controlling), and the EAS adapter harness.

STEP 3 - Next plug the adapter into the Power Switch

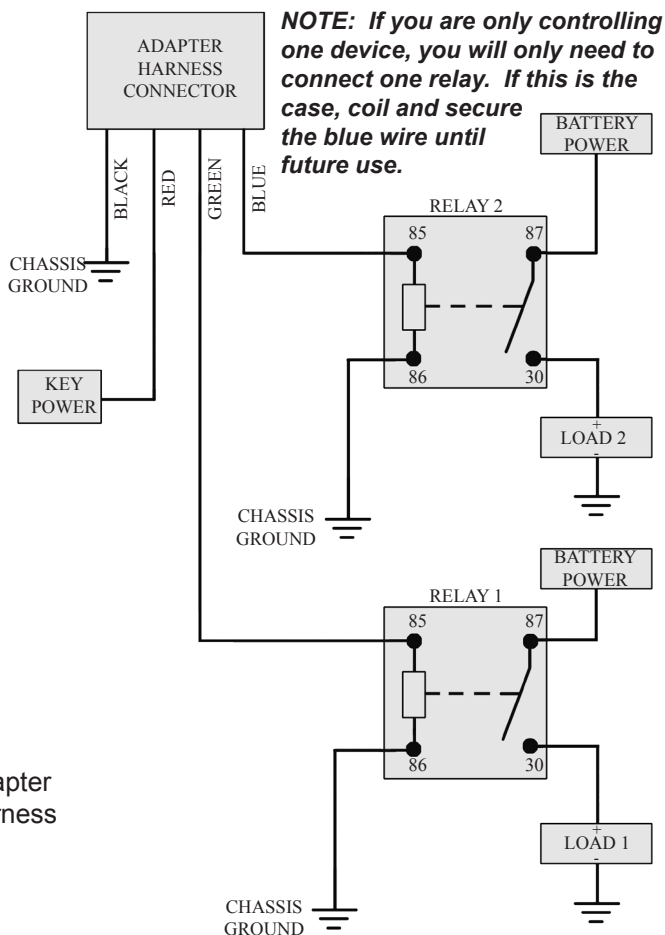
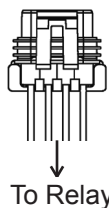
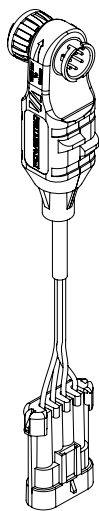

NOTE: If you are only controlling one device, you will only need to connect one relay. If this is the case, coil and secure the blue wire until future use.

Monitor Tools with Power Switch - Device 1

STEP 1 - Once all of the proper connections are made, turn the key to the ON position.

STEP 2 - Enter the Quick Link menu (pull-up menu).

STEP 3 - Press the Screen Layout Icon

STEP 4 - Select either Layout 1 or Layout 2.



STEP 5 - Select the Switches screen option.

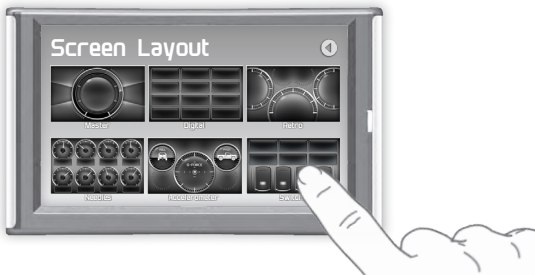

STEP 6- Return to the Home  screen.

STEP 7 - Swipe horizontally to switch between your selected layouts.

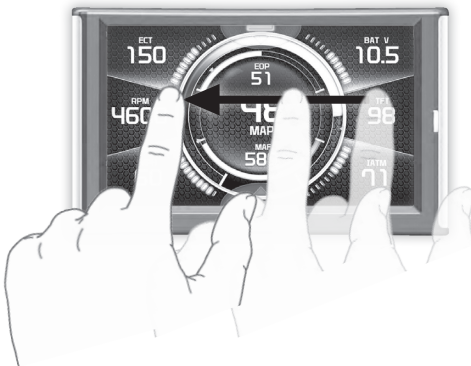

The display will detect the newly installed Power Switch during boot up. Once detected, the first two buttons (left) will automatically be populated.

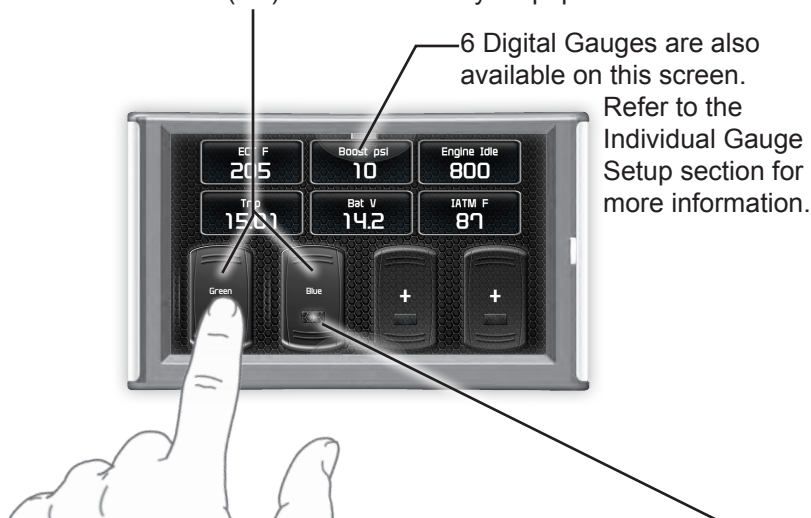

STEP 8 - To toggle the switch On or Off, simply press the switch. The light indicator will illuminate when the switch is On.

If you would like to customize a switch:

STEP 9 - Touch and hold the switch for 3 second, then let off. A menu will appear.

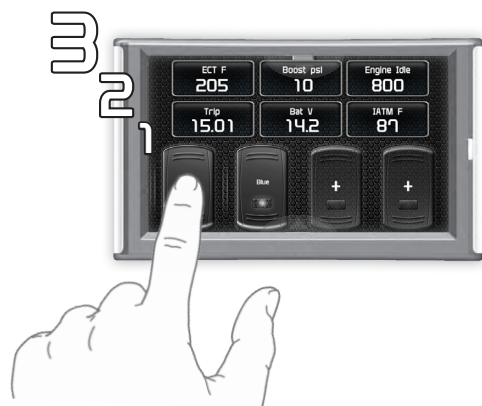

STEP 10 - Select each option and make your adjustments accordingly:

The default name for each Power Switch that corresponds to the wire on the Power Switch pigtail. (SW2 is blue)

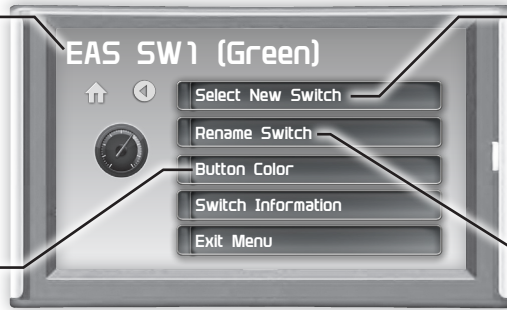

Allows you to select which device you are controlling. You may also Deactivate the switch location.

Changes the color of the illuminated indicator when the switch is On.

The new name can be up to two words with less than 12 characters per word.

STEP 11 - Return to the Switch Screen to see the changes you have made.

Monitor Tools with Power Switch - Device 2

For more information on how to select new PIDs, refer to the display device's user manual.

STEP 1 - Start the vehicle. **NOTE: Once the Power Switch has been installed, the vehicle will need to be started so that the display device (i.e. Attitude, Evolution, or Insight) can detect the Power Switch.**



STEP 2 - Press the Enter button. One of the PID locations will be highlighted.

STEP 3 - Use the arrow buttons to highlight the PID location you would like the Power Switch PID to be, then press Enter to open the PID Sub Menu.



STEP 4 - Choose "Select New PID" from the list.

STEP 5 - Scroll down through the list of available PIDs and select the EAS SW1 (Green) option. (or EAS SW2 (Blue) if you are controlling a second device).



STEP 6 - Return to the gauge screen.

STEP 7 - Press the Enter Button and use the arrow buttons to highlight the Power Switch PID.

STEP 8 - Press the Enter Button to turn ON/OFF the Power Switch.

NOTE: To change the PID location to something different, press and hold the Enter button for 3 seconds while the PID location is highlighted. This will open the PID menu.



Monitor Tools with Power Switch - Device 3

When an EAS Power Switch is connected this tool, a new switch page is automatically added to the Gauged mode. It is added in the very first slot, to the far left of the gauge pages. The switch page will be automatically populated with connected switches (up to 4). You also have the option of placing a switch on any digital gauge.

Switch Operation:

- A single tap on a switch, or digital gauge holding a switch, will change the state of the switch.
- A long press and hold on a switch, or digital gauge holding a switch, will enter the Switch Customization Menu.



Switch Customization Menu:

Users can change the switch look, and LED color through this menu.

Gauges Mode Operation with EAS Power Switch connected:

- If an EAS Switch module is present, the sleep timer is extended to 30 seconds. The 30 second timer is also used if a device is woken up by a tap (warm boot).
- If a switch is toggled to the ON position, the sleep timer is suspended until the switch is toggled to the OFF position. Once the switch is toggled OFF, the sleep timer will begin counting down.



EAS 12V Power

Connecting to Power

For older vehicles not equipped with an OBDII port, a kit may be purchased along with an EAS 5V Sensor to provide vehicle parameters without OBDII.

STEP 1 - Locate a KEY-ON power source. A KEY-ON power source is only ON when the ignition is in the ON or RUN position. Connect the RED (+) wire to the KEY-ON source.

STEP 2 - Locate a bolt or other connection that is grounded to the chassis. Connect the Black (-) wire.

STEP 3 - Route the HDMI connector up to the display device (Insight).

STEP 4 - Plug the HDMI connector into the back of the display device (Insight).

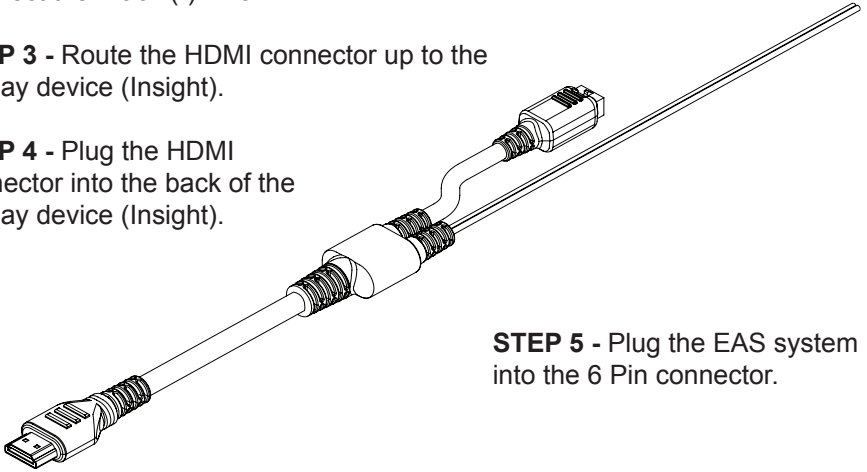

STEP 5 - Plug the EAS system into the 6 Pin connector.

MyStyle

Starting MyStyle

NOTE: MyStyle is only for use with the Edge Products CS, CTS, CS2, and CTS2. If your tool/monitor is not one of the previously mentioned devices, check the user manual for your tool/monitor for instructions on EAS compatibility and customization.

This section explains how to use the MyStyle software to configure your sensor output data so it can be read and interpreted properly on your Display device. In order for you to complete the following steps, you will need:

- 1) Access to a computer.
- 2) Display Device
- 3) USB Cable (See Quick Install Guide)
- 4) MyStyle Program installed on your computer.

STEP 1 - Remove and unplug your Display Device from the truck completely. (For those who have laptops, do not leave the OBDII cable plugged into the device while using MyStyle.

STEP 2 - Double-Click the MyStyle Icon located on your desktop or the start menu.

STEP 3 - The computer will ask you to “Please connect your device to continue”.

STEP 4 - Plug the USB cable into your computer and into to side of your device and set it aside.

STEP 5 - The following screen will appear on your computer. The button in the center of the screen will display your device’s serial number.

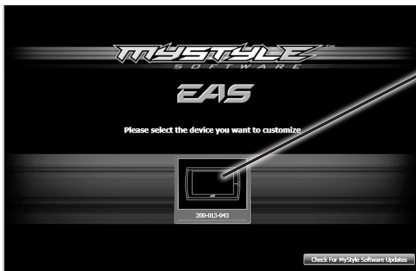

NOTE: Look to the lower right of the screen. There is an option to “Check for MyStyle Software Updates”. It is always good to update each time you open MyStyle.

STEP 6 - Click the button to continue.



STEP 7 - Click the button labeled “Customize EAS Devices”.

Universal Sensor Input - Explained

PRESSURE
UNIVERSAL
TEMPERATURE

Previously in the Universal Sensor hardware install section of this manual, it explained that you will need to pay attention to the letter on the connectors.

“A” = Sensor A

“B” = Sensor B

The following describes each feature in Figure 48 (next page). These descriptions apply to both Sensor A and B configurations:

- ① **S/N:** The serial number of your EAS device.
- ② **Gauge Name:** The name that will be displayed on the gauge screen.
- ③ **Long Name:** The name that is shown in the PID selection menu.
- ④ **Description:** Will be displayed in the “PID Info.” menu on the device.
- ⑤ **Mapping:** Choose custom or pick from any of the default sensors.
- ⑥ **Pull-up Value:** This option can only be used in custom mapping.
- ⑦ **Alert:** The alert allows you to set a maximum or minimum value that will trigger a PID alert.
- ⑧ **Units:** The unit of measurement for your particular sensor. An example would be “psia” for an Absolute Pressure Sensor.
- ⑨ **Input Table:** These tables cannot be edited unless custom mapping has been chosen.

S/N: 1 Switch to CNG

Sensor A

Gauge Name: TRNTEMP

Long Name: Transmission Temp

Description: Measures transmission temp fl

Mapping: Custom Resistive

Pullup Value: 1 KΩ

Alert: > 90.000

Voltage (V)	F	
0.000	105.00	
0.000	55.00	
0.000	25.00	
0.000	0.00	
0.000	-25.00	
0.000	55.00	

Change # Inputs

Sensor B

Gauge Name: FUELPRE

Long Name: Fuel Press.

Description: Measures the system pressure

Mapping: Pressure Sensor 0-50 PSIG

Pullup Value: None

Alert: > 45.000

Voltage (V)	psig	
0.000	0.00	
0.000	50.00	

Save Cancel

Universal Sensor Input - Custom Mapping

If you chose to install a sensor that is not called out as a default sensor, you may choose to create custom mapping.

STEP 1 - Choose the custom mapping option according to your type of sensor. The two choices are:

Voltage (V)
Resistance (ohms)

Most sensors will have data sheets that contain a chart of values that you can use to input into the Mystyle chart.

For example, in the case of a Temperature Sensor (Thermistor), the chart will

RESISTANCE (Ohms)	TEMP C
96.40	-55
13.03	-25
3.27	0
1.00	25
0.30	55
0.06	105

have a temperature value (Usually in degrees Celsius) that corresponds to a resistance value.

NOTE: It is important that you label your units properly. For example, if your chart gives you degrees in Celsius, make certain that the Unit of Measure you input matches that value type.

In this case, you would choose the Resistance (ohms) Custom option.

Another example would be that of a Pressure Sensor. In the following chart, there is a Pressure value that corresponds to a Voltage Value.

VOLTAGE	PRESSURE (KPa)
4.9	0
4.4	10
3.8	20
3.3	30
2.7	40
2.2	50
1.7	60
1.1	70
0.6	80
0.3	90
0.3	100

In this case, you would choose the Voltage (V) Custom option.

If your data sheet does not come with a chart, but rather gives you an equation to use, you will need to calculate the input values based on the equation variables.

STEP 2 - Choose a Pull-up Value. The values available are 10K ohm, 1K ohm, or None. To help determine which pull-up value to use, refer to the following rule of thumb:

- 3 wire sensors: None
- 2 or 1 wire sensors: 1K or 10K

If for example your sensor is a single wire Temperature sensor, and is rated as 1K @ 25C, you would want to use a 1K pull-up. **You want to match your pull-up value as close to the sensor rating as possible.**

STEP 3 - Set the alert value according to your specific sensor. Depending on the sensor, the alert value will be either a maximum or a minimum value.

For example, if you have a pressure sensor, and you want the device to alert you when the sensor reads greater than or equal to 90 psi, set up the values as shown:



STEP 4 - Fill in the Unit of Measure value. This will be displayed on the main gauge screen. Only 4 digits are allowed.

STEP 5 - Input the chart data. Most sensors will have data sheets that contain a chart of values that you can input into the Mystyle chart. These will look similar to the charts in Figures 49 and 50 on the previous pages.

For non-linear output sensors, the more data points you can enter, the more accurate your custom mapping will be. When the sensor output is linear, only the maximum and minimum values are needed.

NOTE: *You probably noticed the button in the upper right hand corner labeled "Switch to CNG". We offer CNG kits for fleet vehicles, which are not yet available to individual users. This allows them to modify a PID that uses temperature and pressure to calculate the fuel level in their CNG tank.*

STEP 7 - Click the "Save" button, and you will be directed to the previous screen.

STEP 8 - Click the "Save Configuration" button to upload the changes to your Display Device.

EGT Sensor



If you are modifying an EGT Device, note that you are only allowed to change the names and descriptions.

STEP 1 - Update/change names and description.

STEP 2 - Click the “Save” button, and you will be directed to the previous screen.

STEP 3 - Click the “Save Configuration” button to upload the changes to your Display Device.

Display Setup

Now that you have modified and saved your Mystyle data, you can setup and display your EGT or Universal Sensor Input PIDs on the Display Device.

STEP 1 - Disconnect your device from Mystyle, and reinstall it in your truck.

STEP 2 - Follow all on-screen instructions until your main gauge screen is displayed.

STEP 3 - While viewing the main gauge screen, choose the gauge you would like to modify.

STEP 4 - Select the EAS Device you created and modified in Mystyle from the “Select New PID” options list.

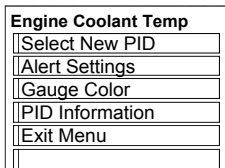

STEP 5 - Select the “Alert Settings” menu for the ability to turn on or off the alert option for your new PID. This menu also allows you to specify the set point at which the alert will be triggered.

STEP 6 - Exit the menu and return to the main gauge screen to verify that the new PID is reading correctly.

For more information regarding the functionality of your Display Device, refer to it's User Guide.

Use Mystyle to rename the Power Switch to better fit your

Power Switch

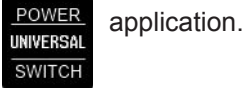

STEP 1 - Next, modify the name and description according to your specific application. The Button Name will be what is displayed on the device.

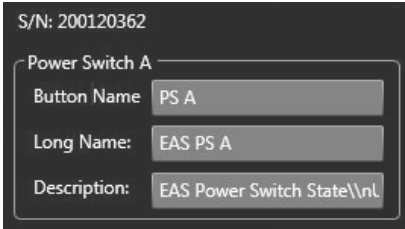

STEP 2 - Save, then exit Mystyle.

STEP 3 - Disconnect your device from your computer, and reinstall it in your vehicle.

STEP 4 - Follow all on-screen instructions until your main gauge screen is displayed.

STEP 5 - While viewing the main gauge screen, press the UP arrow button to change between the gauge screens. Refer to your Display Device user manual for more information.

STEP 6 - After locating the correct screen, the name you had changed will appear. Pressing this button will turn on/off your switched connection.

Copyright© 2021

D10006700 Rev07 6/15/2021

For additional questions not found in the user guide call:

Edge Products Technical Support: (888) 360-EDGE (3343) 6:00 am - 6:00 pm MST

**To expedite your support call, please have your Vehicle Information,
Part Number, and Serial Number ready prior to calling Technical Support.**