

# Installation Manual

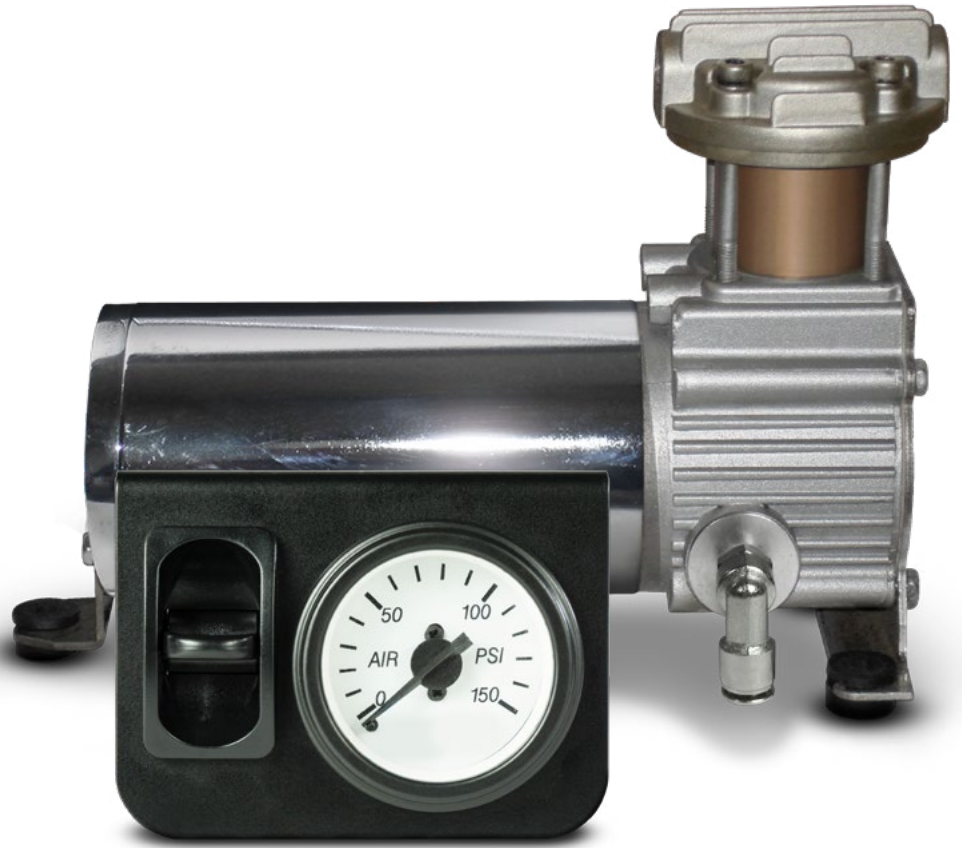

## **PREMIUM IN-CAB CONTROL KIT**

**w/ 325 SERIES AIR COMPRESSOR**  
*(for vehicles without a preexisting air system)*

**10135 SIMULTANEOUS ACTIVATION**  
Paddle Valve w/ Mechanical Gauge

*Operate your air springs (or other pneumatic accessories)  
right from the driver's seat.*

**Thank you & congratulations on the purchase of a Premium In-Cab Control Kit with simultaneous air spring activation via a Mechanical Paddle Valve switch.**

- This Premium Kit is for vehicles without an existing onboard air system. Basic kits are available for those with a pre-existing air system on their vehicle.
- This kit is designed to fill and exhaust both air springs to the same pressure simultaneously. *Air Spring Kit sold separately.*

**IMPORTANT**

This kit is not recommended for vehicles carrying slide in campers or other loads which the load is above the cab. Air spring inflation kits that simultaneously fill both air springs through one supply / discharge line do not prevent air transfer from one air spring to the other when cornering.

*If this is a concern to the customer, contact Customer Service at 800.663.0096 for an **Independent Air Spring Inflation Kit** option.*

**BEFORE STARTING THE INSTALLATION:**

1. Read through this manual and ensure you can complete the installation once started.
2. Ensure the kit you recieved contains all the items shown in the kit layout photo below.
3. It is recommended to use a good quality anti-seize on all fasteners. This will reduce the chance of corrosion on the fasteners and will help facilitate removal, if required at a later date.

**PLEASE NOTE:**

***This kit contains push-to-connect fittings; using scissors or wire cutters to cut the nylon airline will distort the line and cause the connection to leak. THE AIRLINE MUST BE CUT OFF SQUARELY WITH THE NYLON HOSE CUTTER PROVIDED IN THIS KIT OR A SHARP UTILITY KNIFE.***



- 1 Choose a location to mount the gauge and switch panel. It should be in reach and in clear view to the driver.

Using the bracket as a template, mark and drill 2 - 3/16" holes to secure the bracket.

Do not install the bracket until the electrical and airlines have been installed.



1

- 2 **INSTALL THE AIR SPRING ASSEMBLIES**  
*(if not previously installed).*

Follow the installation instructions provided in your air spring kit - with the exception of airline routing.

- 3 **PLEASE NOTE: Thread sealant or Teflon tape must be applied to all the fitting threads installed throughout this installation to prevent air leaks.**

Install the push to connect fitting into the check valve, then install the assembly into the outlet port of the compressor head, (as shown in the Figure 2).

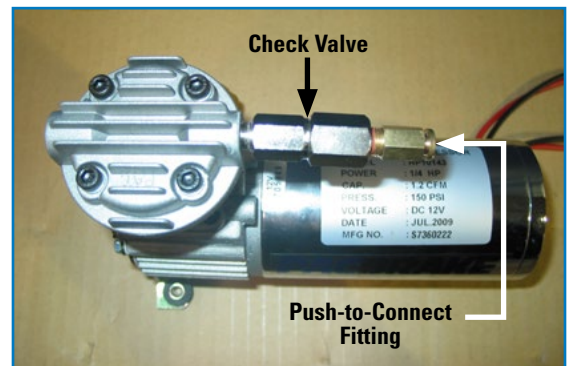

3

- 4 **PLEASE NOTE: The compressor makes an audible pumping noise when activated. Consider this when choosing a mounting location. The location should also be in a clean, dry area to maintain long compressor life.**

Using the compressor as a template, mark and drill four 3/16" diameter holes. Secure the compressor using the fasteners provided.



5

- 5 **COMPRESSOR AIR INTAKE FILTER**

The air intake filter is remote mounted. Locate a clean, dry area for the filter housing. Install the barbed fitting provided to the filter housing. Using the nylon hose marked "air intake", connect the filter to the barbed fitting at the compressor and secure the hose with the tie-straps provided.

## 6 ELECTRICAL CONNECTIONS

Provided in the kit is a pre-wired relay receptacle to make this part of the installation easy.

Find a convenient location to mount the relay receptacle close to the positive battery terminal.

Using the self tapping screw provided, secure the relay receptacle and install the relay provided.



6

- 7 Locate either one of the two RED 12 gauge wires of the relay harness. Cut to length and connect the 30 amp fused link.

Connect the 30 amp fused link to the positive terminal of the battery (as shown in Figure 7A).

Locate the second RED 12 gauge wire and route to the compressor (as shown in Figure 7B). Cut to length and crimp on the supplied connector, then connect to the RED compressor wire.

Locate the BLACK wire of the compressor and connect to a good chassis ground or the negative battery terminal.



7A

- 8 Locate the 16 gauge RED with WHITE strip and WHITE wire of the relay harness.

Route these wires into the cab through the firewall boot.

Using the "T" tap connector provided, connect the RED with WHITE strip wire to the 5 amp inline fuse provided, then to a 12 volt ignition power source.

Test the ignition power source with a volt meter prior to attaching the "T" tap. Some ignition circuits are less than 12 volts which may not be enough to activate the relay coil. This wire can be connected through an ON/OFF switch to override the compressor activation, should the customer prefer this option. (Switch available separately and not provided in this kit).



7B

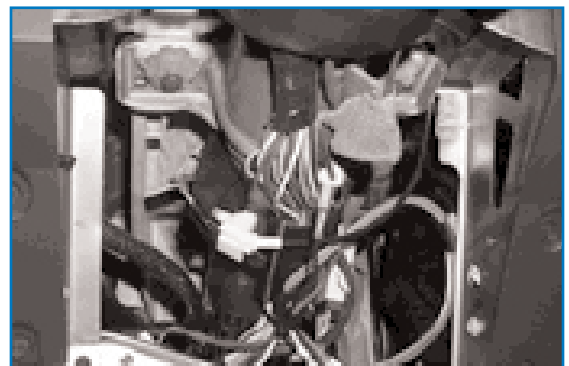

8

- 9 At the rear of the air pressure gauge, locate the two spade terminals (shown by the arrows in Figure 9). These are for the gauge lighting.

Using the RED 'T' tap provided, connect to the dashboard illumination circuit. Crimp the insulated male blade terminal to the RED fused wire provided. Connect to the 'T' tap. Using the BLACK wire and terminals provided, connect the other terminal to a good chassis ground.

**NOTE: If you do not wish to have the ability to dim the gauge light with the vehicles dimmer switch, then attach the 'T' tap and inline fuse to a 12 volt + ignition power source**

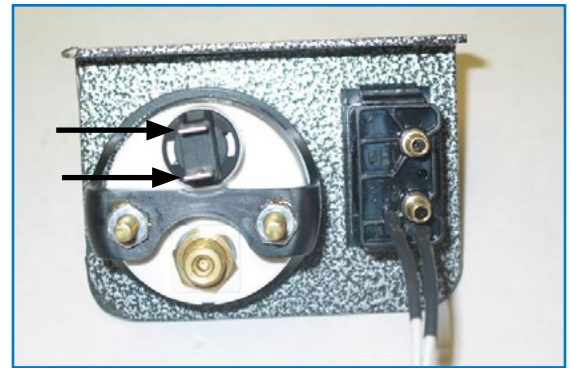

9

- 10 At the rear of the paddle switch are two white wires. These make a connection when the paddle switch is moved to the upper (inflate) position. This is an optional circuit to enable the air compressor when inflating the air springs.

One wire needs to be connected to a good chassis ground. The remaining WHITE wire of the paddle switch is connected to the WHITE wire of the relay harness previously installed in Step 9.

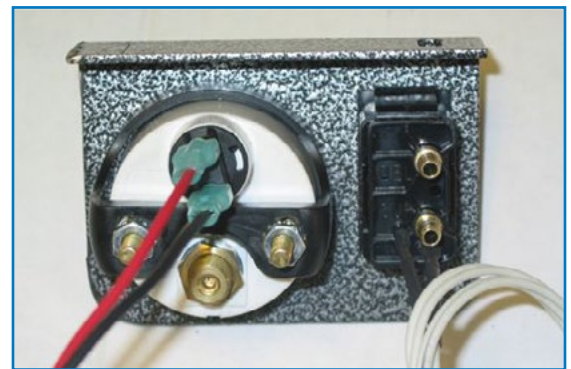

10

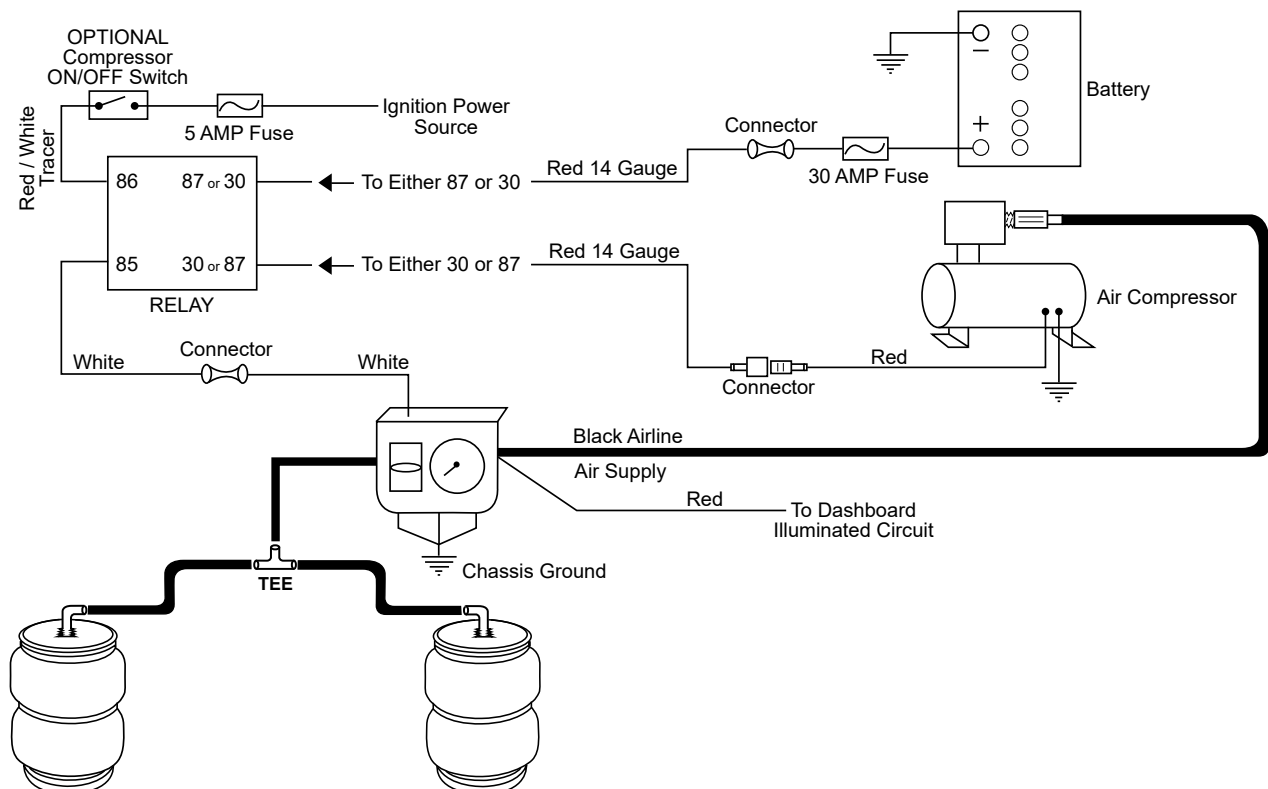

**11 GAUGE PLUMBING**

**PLEASE NOTE:**

*This kit contains push-to-connect fittings; using scissors or wire cutters to cut the nylon airline will distort the line and cause the connection to leak. THE AIRLINE MUST BE CUT OFF SQUARELY WITH THE NYLON HOSE CUTTER PROVIDED IN THIS KIT OR A SHARP UTILITY KNIFE.*

Locate the 1/8" NPT female push to connect fitting provided. This fitting is installed using thread sealant onto the port on the rear of the air pressure gauge (see Figure 11 for reference).

Cut one 2" and one 5" piece of RED nylon airline. It must be cut off squarely with a sharp razor knife to ensure a leak free connection within the push to connect fitting.

Insert one end of the 2" piece of RED airline into the gauge fitting and push it in until it stops.

Connect one end of the 5" piece of RED airline to the paddle switch port marked "DEL".

Using the barbed TEE fitting provided, connect the two RED airlines together and connect the remaining length of RED airline to the unused leg of the barbed TEE.

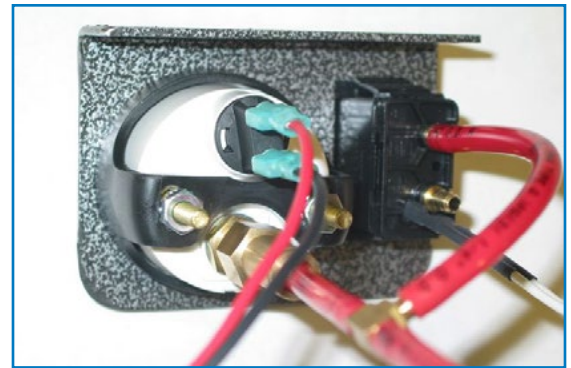

11

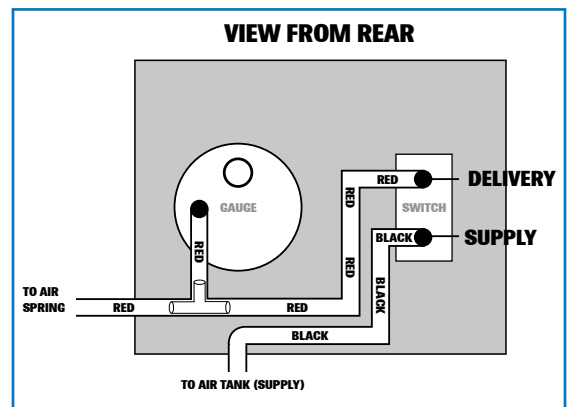

12

**12** Connect the length of BLACK airline provided to the paddle switch port marked "SUP".

Route the BLACK and RED nylon airlines through the firewall boot into the engine compartment. The BLACK airline connects to the air compressor discharge port. Ensure the end of the airline is cut squarely with a sharp razor knife.

The RED airline is connected to both air springs using the second barbed TEE fitting provided.

Secure both airlines with the tie straps provided.

**13** Using the fasteners provided, secure the control panel to the chosen mounting location.

Secure the wiring and airlines with the tie straps provided.

## 14 TESTING THE SYSTEM

Turn the ignition ON, move the paddle switch to the UP position. The needle of the gauge should show air pressure being delivered to the air springs raising the vehicle. Then move the paddle switch to the lower position. The needle of the gauge should show the air pressure dropping and lowering the vehicle. Check the system for air leaks, fill the air springs to a predetermined value, then periodically check the gauge for any air pressure loss. Repeat as necessary.

**DO NOT EXCEED 100 PSI TO THE AIR SPRINGS AT ANY TIME**

## 15 AIR LEAK CHECK

Inflate the air springs to 90 PSI. Use a dish soap and water mixture on all airline connections to detect air leaks. Repair as necessary and retest. Inflate the air springs to a predetermined value and then the following day recheck the pressure. If the air springs have lost pressure, a leak is present. The leak must be repaired and then retest the vehicle until no leaks exist.

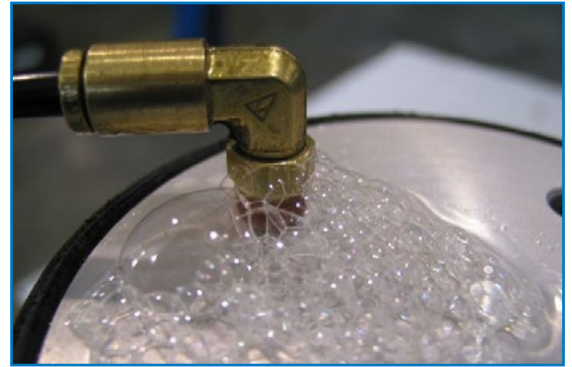

---

## OPERATING YOUR VEHICLE WITH AIR SUSPENSION

Air springs have minimum and maximum pressure requirements. Never operate your vehicle with less than 10 psi in air spring and never inflate air springs over 100 psi. Damage to air springs will result.

Check air pressure in air springs daily for first couple of days to ensure a leak has not developed. Air springs are designed to maintain the vehicles stock ride height with a load. Do not use the air springs as a means to lift vehicle with no load. This will result in a harsh ride.

## SERVICING YOUR VEHICLE WITH AIR SUSPENSION

When lifting the vehicle with a floor jack or hoist on the frame, never allow the air spring to limit the travel of the axle. Try to always jack the vehicle on the axle. Suspending the axle with the air spring limiting the axle travel will damage the air spring and void the air spring warranty.

## WARRANTY

To be eligible for warranty, the owner must submit their warranty card or register online within 30 days of the purchase date.

**NOTE: The owner's warranty will be void if air springs are run with less than the minimum of 10 psi.**

---