



S&S DIESEL

MOTORSPORT

CP4 to DCR Pump Conversion – Ford 6.7L Power Stroke

Vehicle Fitment: 2011-2019 Ford Super Duty equipped with 6.7L Power Stroke Diesel

Part Number: 6.7F-DCR

SEMA Certificate of Compliance: SC-SDM01-0034
CARB EO: Pending

Installation Instructions

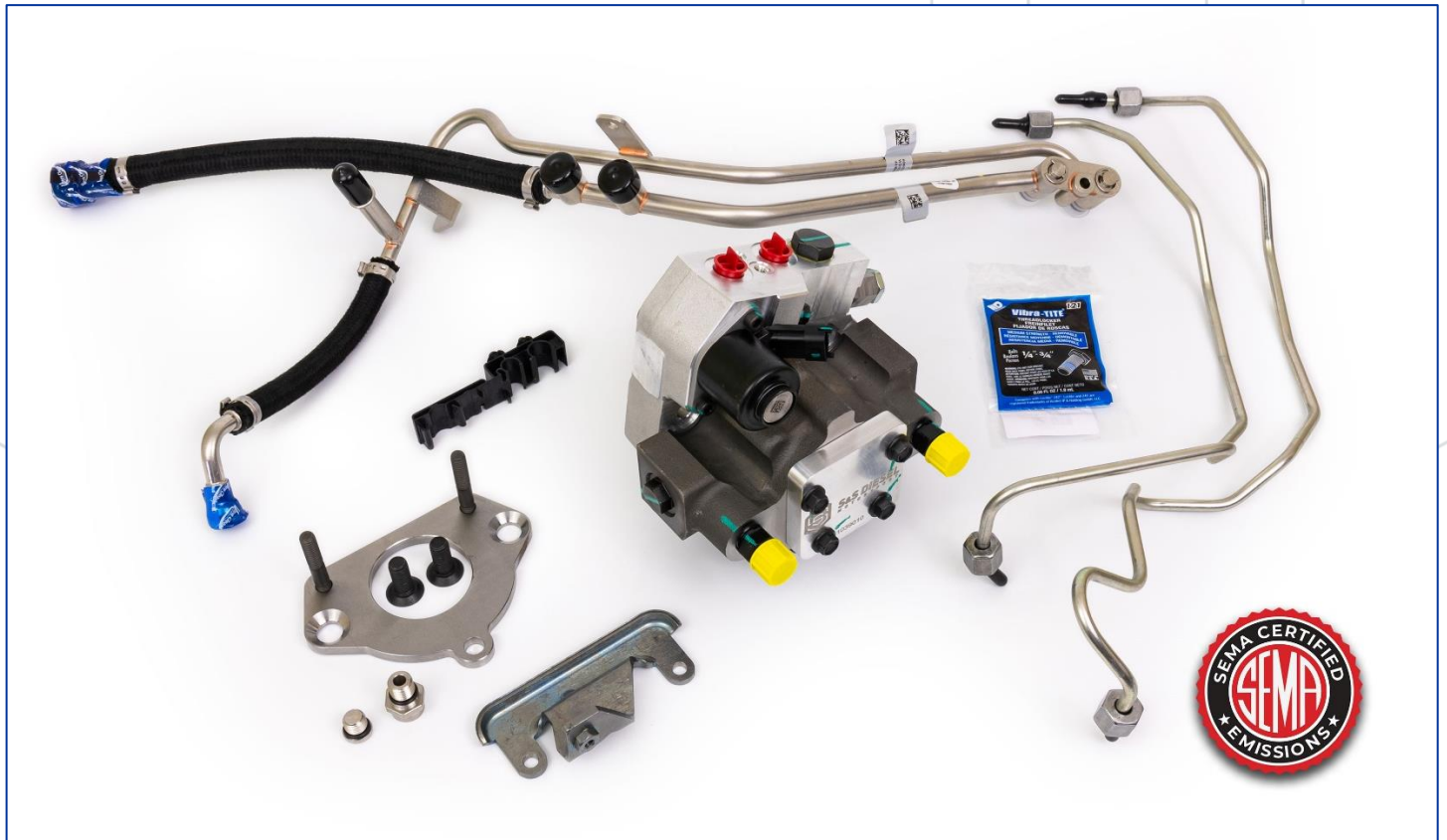

Parts Included in Ford 6.7 CP4 to DCR Pump Conversion Kit:

Please verify that all components stated below are included in the kit you have received:

- S&S DCR High Pressure Fuel Pump - 1x
- High Pressure Fuel Line for Driver Side Pump Outlet Fitting – 1x
- High Pressure Fuel Line for Passenger Side Pump Outlet Fitting – 1x
- Low Pressure Fuel Supply & Return Line Assembly – 1x
- Plastic Clip for Low Pressure Line Assembly (ships with water in the bag to keep the clip flexible) – 1x
- Adapter Plate – Engine Block to DCR Pump – 1x
- Adapter Plate Mounting Bolts - T45 Torx Countersink Head – 2x
- Adapter Plate Studs – 2x
- Pump Tail Support Bracket for High Pressure Fuel Lines – 1x
- Plug for Supply Line for model years 2015+ – 1x
- Sensor Adapter for model years 2015-2019 – 1x
- Vibra-Tite 122 Medium Strength Threadlocker – 1x

Critical Torque Specifications:

Part Description	Standard	Metric	Blue Threadlocker
Pump Gear Nut	60 lb-ft	81 Nm	
Adapter Plate – T45 Torx Countersink Mounting Bolts	25 lb-ft	34 Nm	Yes
Adapter Plate – Studs into the Adapter Plate	Hand Thread into plate		Yes
OEM Pump Mounting Nuts	18 lb-ft	25 Nm	
High Pressure Fuel Line Nuts	26 lb-ft	35 Nm	
High Pressure Fuel Line Clip Bolts	89 lb-in	10 Nm	
Return Fuel Line to Valve Cover Bolts	89 lb-in	10 Nm	
Fuel Supply Line Assembly to DCR Pump - OEM Bolt	89 lb-in	10 Nm	Yes
Vacuum Pump OEM Bolts	89 lb-in	10 Nm	Yes
Fan Clutch to Fan Pulley	98 lb-ft	133 Nm	

Change Log:

- Rev 00 - Initial Release

Tools Needed for Install:

- ¼", ⅜" and ½" Drive Ratchets
- 8mm through 15mm Shallow and Deep Sockets
- 27mm Deep Socket (Pump Gear Nut)
- 24mm Deep Socket or Wrench (Fuel Supply Line Pressure Sensor)
- 18mm 12-point Socket (Crankshaft damper bolts to rotate the engine when timing the fuel pump)
- 17 and 19mm Crows Foot Line Wrench or short Line Wrench Socket (High Pressure Fuel Lines)
- T45 Torx Bit Socket (DCR adapter plate countersink bolts)
- Various ¼" and ⅜" Drive Extensions
- 3/8" Breaker Bar, Long Ratchet, or Belt Tensioner Tool
- 3/8" Torque Wrench
- Flathead Screwdriver
- 8mm through 17mm Wrenches or Ratchet Wrenches
- Blue Primerless Medium Strength Threadlocker – Loctite 243 or Vibra-Tite 122 (Provided in the DCR Kit)
- O-Ring Lubricant – Engine Oil, P80 Emulsion Assembly Lubricant, Ultra Lube, etc
- Fan Pulley Holding Tool (Ford 205-036) and 47mm Wrench (Ford 303-214) to remove the fan
 - *Merchant Automotive Fan Clutch Wrench (PN: 10358), long ½" Extension, and Air Hammer works well*
- Straight and 90-degree Pick
- 5/16" Fuel Line Disconnect Tool (2017+ only)

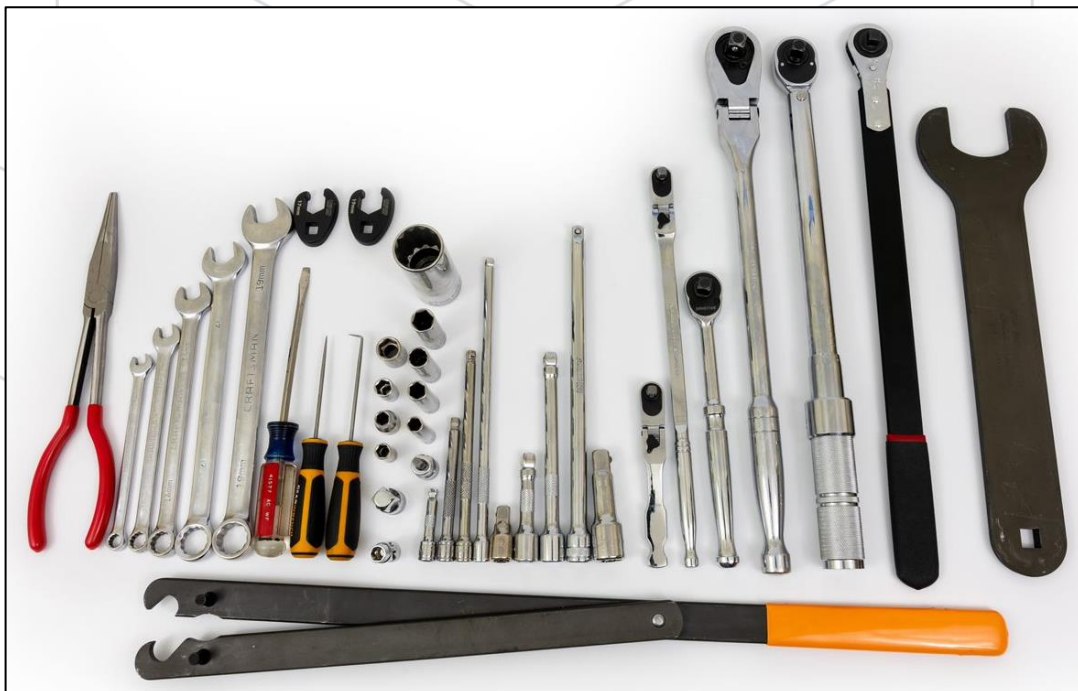

Replacement Ford Part Numbers:

On 2011-2016 trucks, we recommend replacing the Vacuum Pump Gasket. All other seals, gaskets, and hardware listed here can typically be reused.

- Vacuum Pump Gasket: BC3Z-2A572-A / Mahle B32630 / **S&S 6.7F-VAC-GASKET**, BC3Z-2A572-B

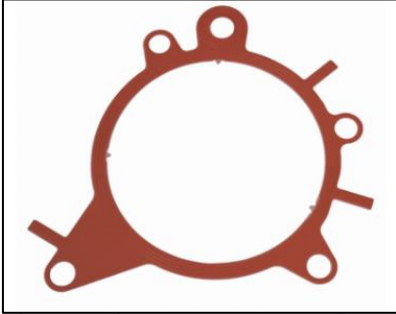

Figure 6: BC3Z-2A572-A for 2011 – 2016 models

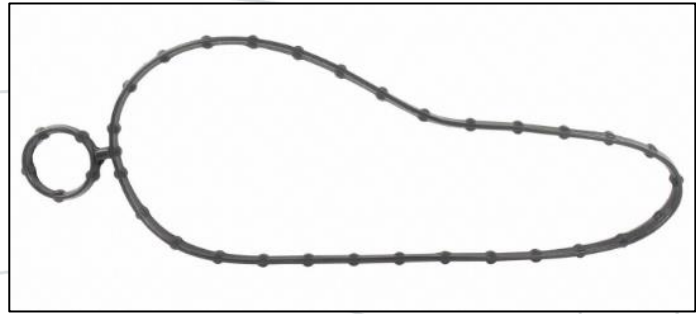

Figure 7: BC3Z-2A572-B for 2017 – 2022 models

- Intake Manifold Gasket: BC3Z-9439-A, BC3Z-9439-B, BC3Z-9439-C

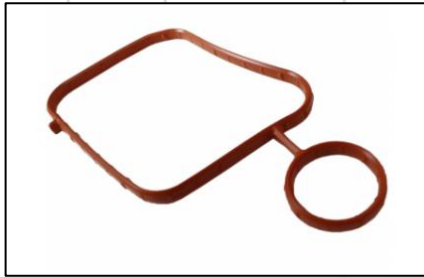

Figure 1: BC3Z-9439-A



Figure 2: BC3Z-9439-B

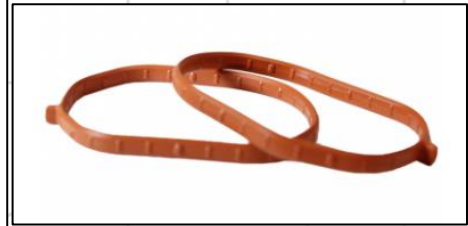

Figure 3: BC3Z-9439-C

- Bypass Valve Gasket: BC3Z-9E464-F & Pump Mounting Stud/Nut: BC3Z-9N943-A



Figure 4: BC3Z-9E464-F



Figure 5: BC3Z-9N943-A

Before removing any components from the engine bay, use compressed air or low-pressure water to clean any debris out of the engine bay. During installation there will be the opportunity for contaminants to get into the engine's air, oil, and fuel circuits.

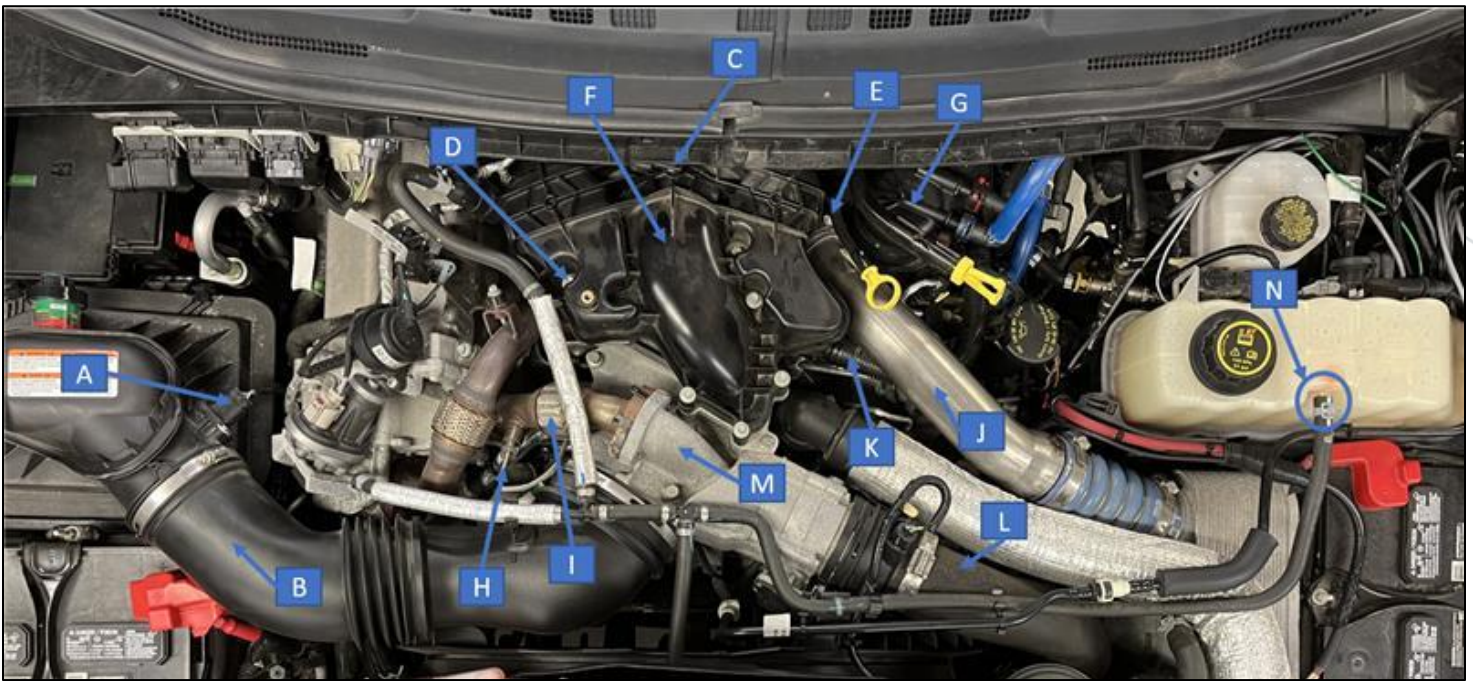

Figure 8: Engine Component Diagram (MY 2017-2019 shown)

CP4 Removal Instructions:

1. Disconnect the negative battery cable from both batteries.
2. Referring to Figure 8 above, remove the air filter intake pipe (Labeled as B).
3. Remove the coolant fill cap to remove residual pressure. Clamp the rubber hose & disconnect the coolant line on the coolant tank and place the line over the passenger side battery area. (Labeled as N)
4. Unplug the MAP sensor on the top of the upper intake manifold (Labeled as C).
5. Remove the coolant and vacuum hose retainer from the upper intake manifold (Labeled as D).
6. Unbolt the transmission and oil dipstick from the upper intake manifold (Labeled as E).
7. Remove the fuel line that connects the fuel filter to the fuel pump's metal feed line. (Figure 9)



Figure 9: Fuel line is removed and not reused

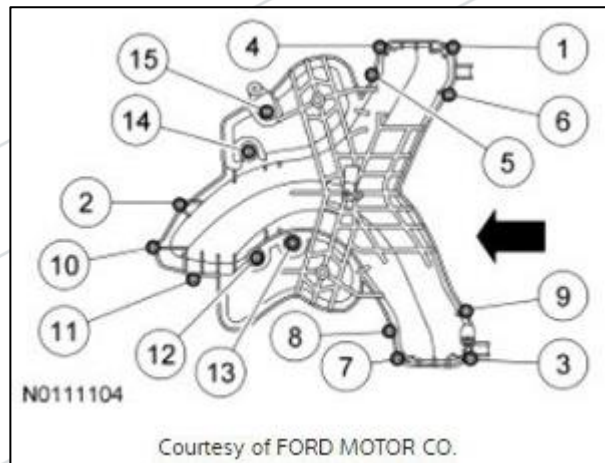

Figure 10: Upper Intake Tightening Sequence (MY 11-19)

8. Remove the hot side intercooler pipe (Turbo to intercooler pipe) (Labeled as J in Figure 8).
9. Remove the upper intake manifold (Labeled as F). Keep track of bolt locations (Figure 10) as the bolts are different sizes.
 - a. On 2020+ models, the upper & lower intake manifolds are removed as a unit at Step 16.
10. On all models, remove the fuel filter and fuel filter housing (Labeled as G).
11. Unplug the EGR temp sensor located in the EGR bypass outlet pipe (Labeled as H).
12. Remove the EGR bypass outlet pipe (Labeled as I).
13. Remove the Crankcase Ventilation hose (Labeled as K) on the lower intake manifold.
14. Remove the cold side intercooler pipe from the intake air throttle and the intercooler (Labeled as L).
15. Unplug the intake air throttle electrical connector.
 - a. On 2020+, unbolt the intake air throttle from the intake manifold to ease removing the upper and lower intakes as a unit.
16. Remove the lower intake manifold (Labeled as M).
17. Remove the top clips from the black fiber cover on the driver's side valve cover to gain access to the fuel lines.

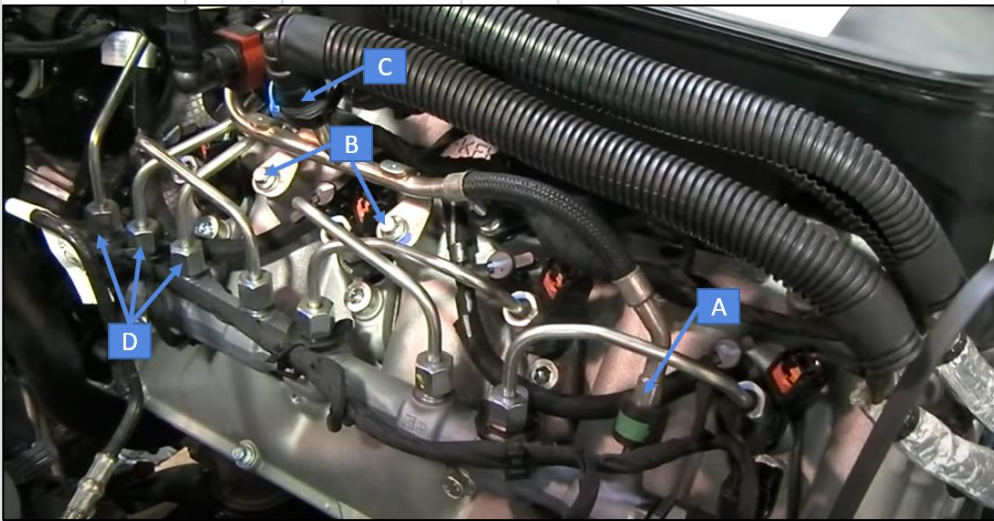

Figure 11: Fuel Line Connection Locations

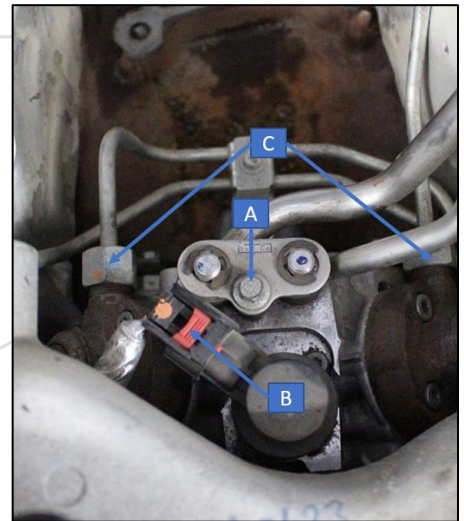

Figure 12: Fuel Lines to CP4 Pump

18. Referring to Figure 11 above, disconnect the low pressure return line from the fuel rail (Labeled as A).
 - a. 2011-2016 – Unlock the Green Quick Connect for removal
 - b. 2017+ - A 5/16" fuel line disconnect tool will be needed to remove this line
19. Remove the two bolts that attach the fuel return line to the valve cover (Labeled as B).
20. Disconnect the fuel return line to the fuel tank from the return line assembly (Labeled as C).
 - a. If a S&S DPK is installed, remove the return filter assembly & rotate the OEM quick-connect fitting (labeled as C in Figure 11) to the original OEM orientation, pointing downward. *(The S&S return filter assembly can remain installed with the DCR pump but S&S recommends removing it as it is not needed).*

21. Referring to Figure 13, remove the hold down bolt (Labeled as A) connecting the line assembly to the CP4 fuel pump in the valley (this bolt will be reused with the DCR pump).
22. Unplug the sensors on the fuel inlet line (Figure 13).
 - a. Note: 2011 - 2014 models have two sensors, 2015+ models have one sensor.
23. Unplug the electrical connectors for the driver's side front two injectors. Use a pick to help release the lock tab.
24. Remove the low-pressure fuel line assembly (Figure 14).
 - a. The OEM sensor(s) in this assembly will be reused. They can be removed before or after line removal.

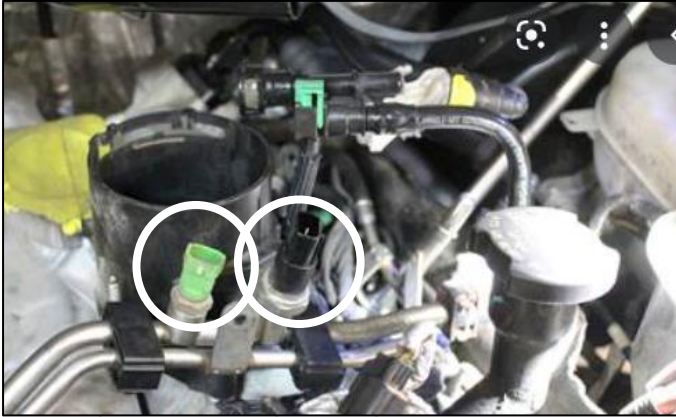

Figure 13: Fuel Supply Line Sensor Locations (MY 11-14 shown)



Figure 14: Low Pressure Fuel Line Assembly

25. Unplug the cooling fan electrical connector (Figure 16).
 - a. Remove the top right bolt in Figure 17 holding the electrical bracket to the fan hub casting in Figure 16.
 - b. Pull the bracket upward to free it from the rubber grommet and tuck the bracket and wire out of the way.
26. Remove the cooling fan (standard threads, counter-clockwise from the front) using the proper Ford fan tools or an air hammer (see Tools section).
 - a. The cooling fan can be left in the truck resting against the radiator. Use cardboard to protect the radiator.
27. Release tension on the accessory belt (Figure 15) & remove the serpentine belt.
 - b. Rotate tensioner clockwise using a 3/8" ratchet to release the belt tension.

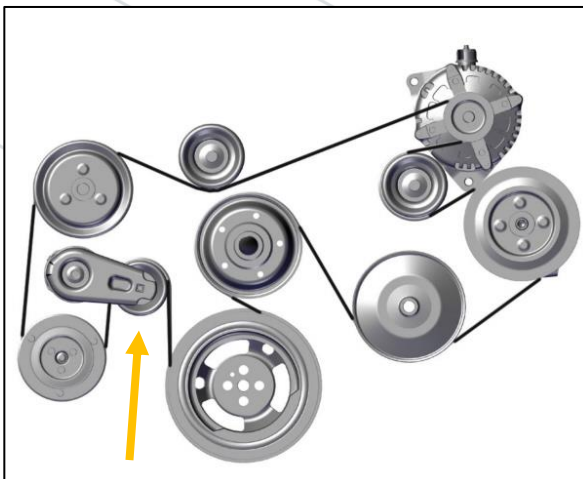

Figure 15: Accessory Belt Layout (Single Alternator)



Figure 16: Cooling Fan Electrical Connector

28. Remove the remaining four bolts securing the cooling fan hub assembly (Figure 17).

29. Disconnect the vacuum line & remove the four 8mm bolts securing the vacuum pump (Figure 18).

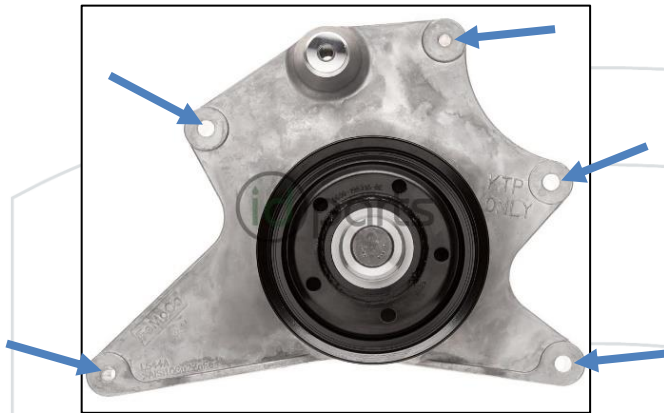

Figure 17: Cooling Fan Hub Bolt Locations

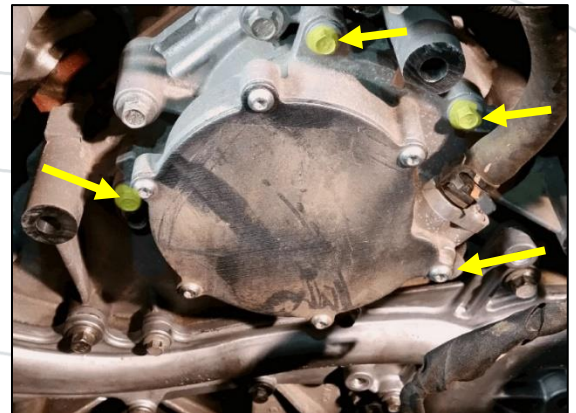

Figure 18: Vacuum Pump Bolt Locations

30. Referring to Figure 12, unplug the fuel control actuator (FCA/VCV) electrical connector (Labeled as B in Figure 12) on top of the CP4 pump.

31. Remove the oil fill tube by removing the bolt, rotating the tube 120 degrees counterclockwise, and then pull up.

c. It is optional to remove the oil fill tube but it eases the removal & install of the high-pressure lines.

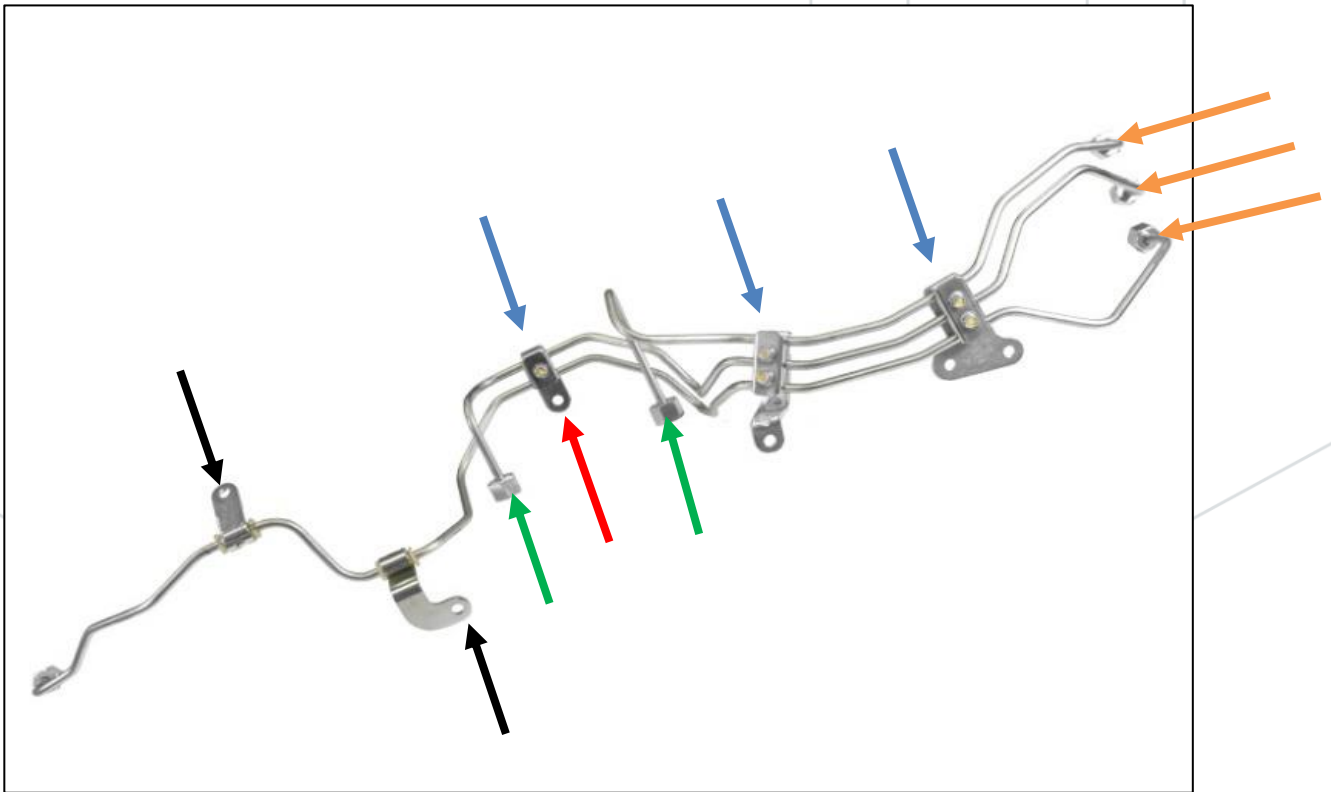

Figure 19: High Pressure Line Assembly Nut and Bolt Locations

32. Remove the high-pressure line assembly (The rail-to-rail high pressure line & two lines from CP4 to rail).

- d. The high-pressure line assembly to fuel rail connecting nuts are labeled as D in Figure 11 and colored in orange in Figure 19.
- e. The high-pressure line assembly to CP4 pump connecting nuts are labeled as C in Figure 11 and colored in green in Figure 19.
- f. Remove the five 8mm bolts holding the saddle brackets in place on the high-pressure line assembly colored in blue and the bolt for the rail-to-rail bracket colored in red in Figure 19.
- g. Remove the rail-to-rail crossover bolts below the EGR cooler colored in black in Figure 19 to allow the crossover line to be flexed towards the turbo compressor inlet.
- h. The rail-to-rail crossover line does NOT need to be removed or disconnected from the passenger side fuel rail. The line can be zip-tied towards the turbocharger to aid in CP4 fuel pump removal.

33. Fuel Pump Timing: Using an 18mm 12-point socket, turn the crankshaft clockwise to roll the engine over until the single mark on the camshaft gear is facing upward as shown (Figure 20).

- i. Use a 27mm socket to remove the fuel pump drive gear nut. A quick jolt should knock it loose, else use impact or hold the crankshaft.

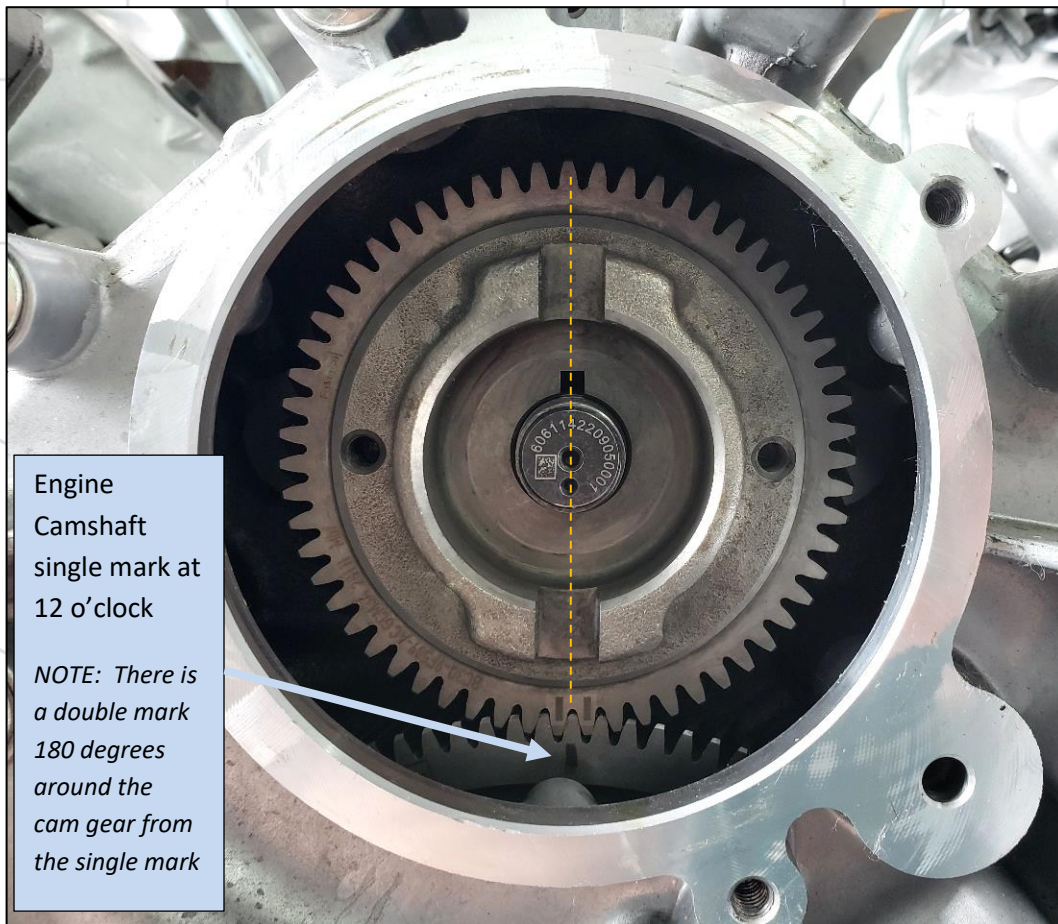

Figure 20: Rotate engine to TDC – Single Mark on the Engine Camshaft at 12 o'clock

34. Remove the three CP4 pump mounting nuts using a 13mm socket.
35. Remove CP4 pump from the engine by gently striking the CP4 camshaft nose to separate the pump from the gear as the gear is a taper-fit and thus requires some force to separate.
 - j. Remove the gear and inspect the gear / gear teeth to ensure they are not damaged as the OEM gear will be reused with the new DCR pump.

DCR Pump Installation:

1. Remove the upper two 15mm CP4 mounting bolts (Figure 21). Be careful not to drop the mounting bolts in the front cover. It is a tight fit, but the bolts can be removed through the CP4 gear cover hole.
 - a. Tip: A short socket with a ¼" wobble extension or a 15mm u-joint socket works well for this.
 - b. Tip: While getting the bolt head to clear the cover hole, continue to loosen the stud to prevent binding in the threads to aid in removing the bolt through the front cover.

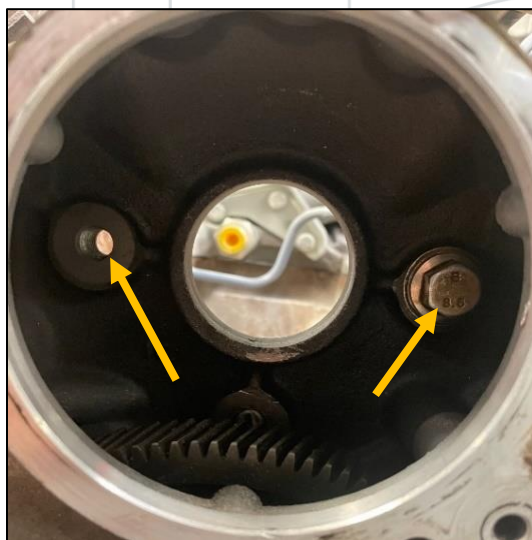

Figure 21: CP4 Mounting Bolt Locations

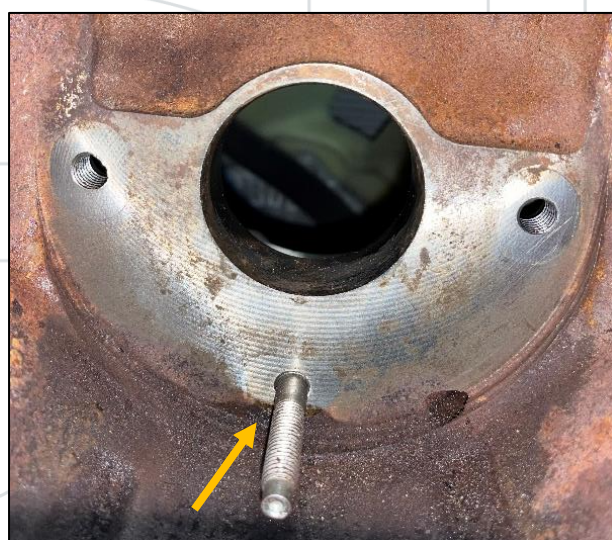

Figure 22: Pump Mounting Surface Cleanliness

2. Use a rag with a cleaning solvent and clean the area where the CP4 pump was located (Figure 22).
 - a. Use a razor blade or other flat scraper to ensure the surface is completely flat and free of debris. This will allow the DCR pump engine adapter plate to sit flush against the engine block. **It is critical for this surface to be clean and flat for proper pump alignment.**
3. Install the DCR Pump Adapter Plate to the Engine Block (Figure 24).
 - a. **Thread Check:** Hand thread the two countersink bolts into the block prior to installing the mounting plate. If the bolts do not thread with ease, use a M10x1.5 thread chasing tool to clean up the threads in the block.
 - b. Put blue threadlocker on the threads of the two T45 Torx countersink bolts (Figure 23).
 - c. Put grease, oil, or assembly lube on the tapered head of the T45 Torx bolts to reduce friction during assembly.
 - d. Tighten the two T45 Torx bolts evenly. Once both are snug, final torque to **25 lb-ft.**

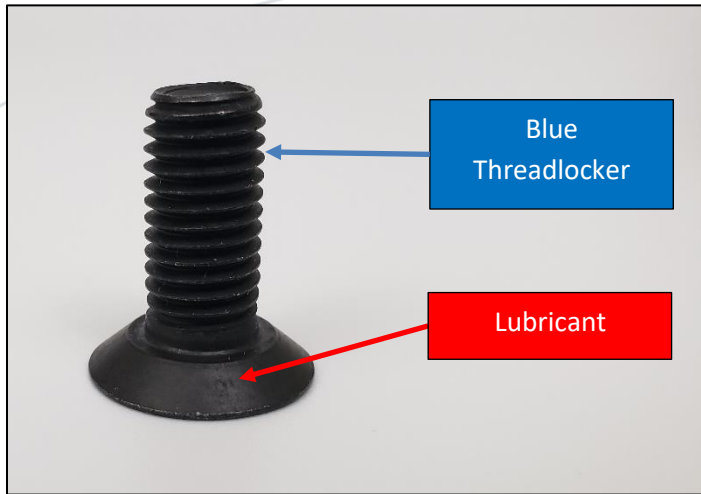

Figure 23: Countersink Bolts

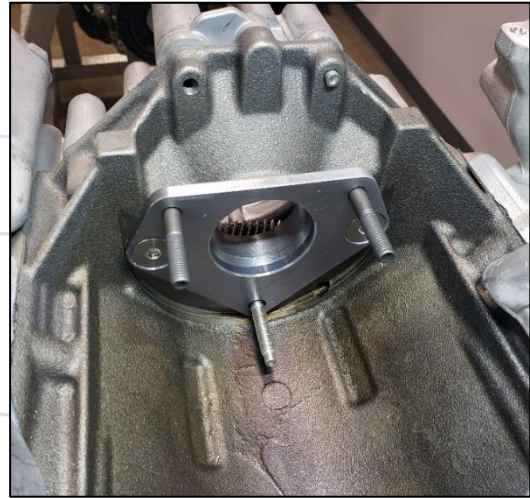

Figure 24: Engine Adapter Plate Installation on Engine Block

4. **Install the short, threaded side of the mounting studs into the engine adapter plate (Figure 24).**
 - a. Put blue threadlocker on the short side of the mounting studs where they install into the adapter plate.
 - b. Thread the studs into the adapter plate by hand until they are fully seated on the shank of the stud.
5. **Fuel Pump Timing:** Place the pump on a workbench in the orientation shown in Figure 25. Rotate the pump shaft until the offset drilling on the end of the pump shaft is facing downward (6 o'clock position).

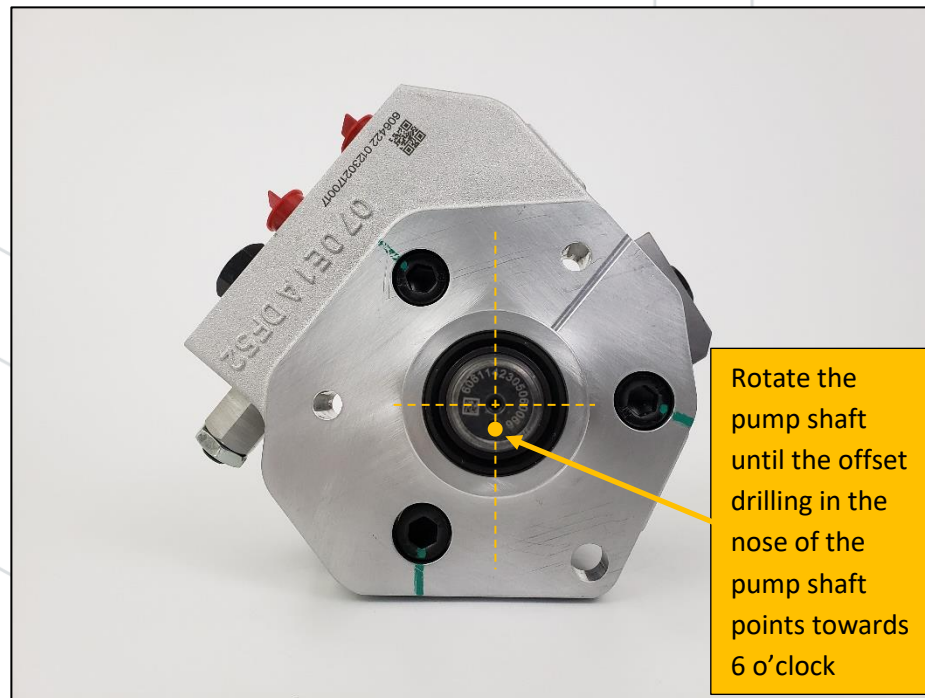

Figure 25: Fuel Pump Timing on Workbench – Offset Hole Location

6. **Lubricate the pump's pilot flange O-ring with clean engine oil or o-ring lubricant.**

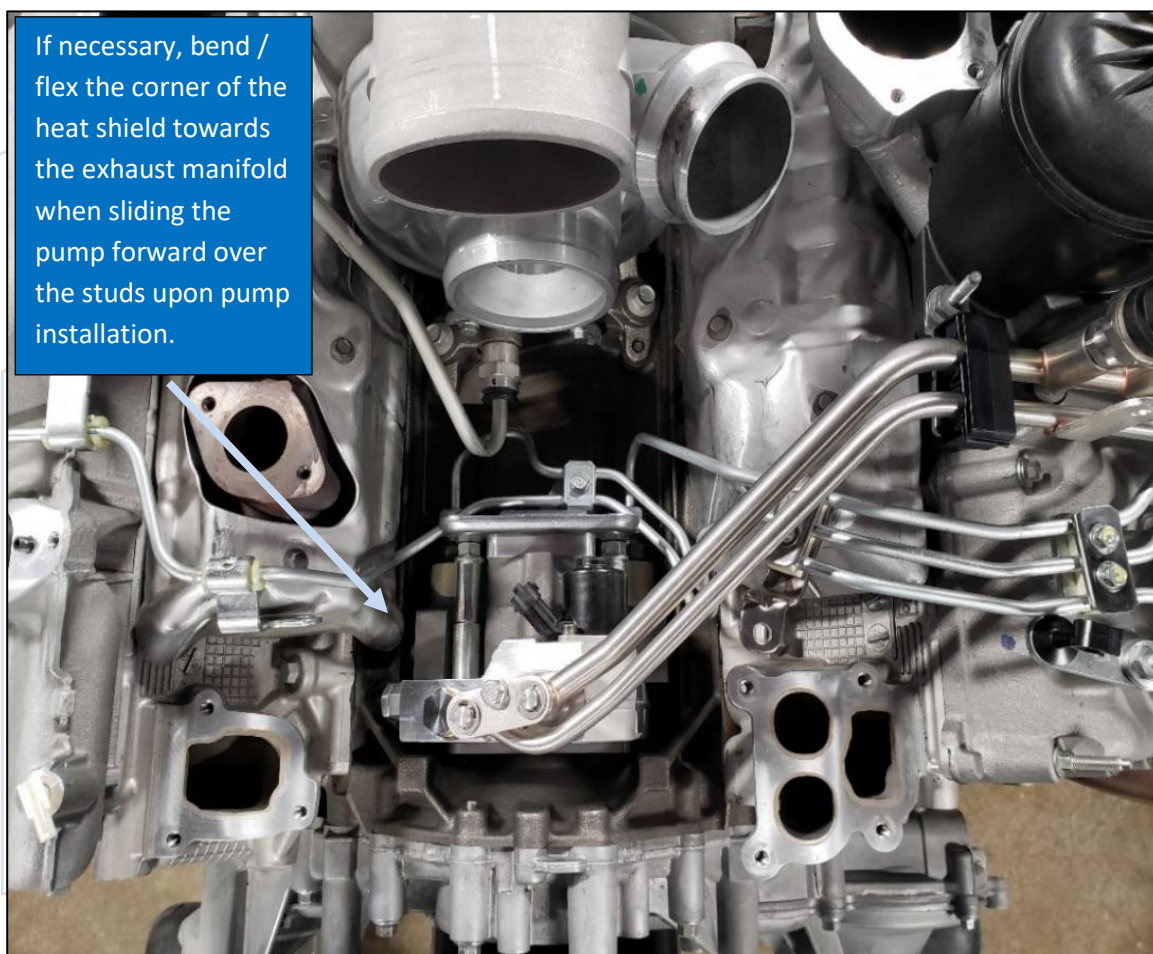

Figure 26: DCR Pump & Lines Installed

7. Lower the DCR Pump into the valley with the pump shaft pointing downward towards the Adapter Plate pilot hole. Once the pump shaft is in the gear cover, align the pump with the 3 mounting studs and slide the pump forward.
 - a. The high-pressure crossover line can be zip-tied towards the turbo to provide space to install the pump.
 - i. **Do not** damage or excessively bend the rail-to-rail high pressure line while installing the pump.
 - b. If the pump is contacting the passenger side heat shield, it may be necessary to bend/flex the heat shield towards the exhaust manifold in order to provide clearance (Figure 26)
 - c. Push the pump into the engine block until it is seated flush.
 - i. Do not use the mounting bolts to pull the pump into position.
 - d. Install the OEM mounting nuts on all three studs and hand-tighten them evenly.

8. **Fuel Pump Timing:** Confirm that the DCR pump shaft did not rotate during assembly by visually checking that the offset drilling is pointing towards 7 o'clock as shown in Figure 27.
- Install the gear in the same orientation that it was removed with the double marks on the gear straddling the single mark on the engine's cam gear. Gear keyway at 12 o'clock.
 - A future design change to the DCR will add a pin to the shaft to set the timing to eliminate the need for this manual timing process. The DCR timing process will then match the CP4 timing process.*

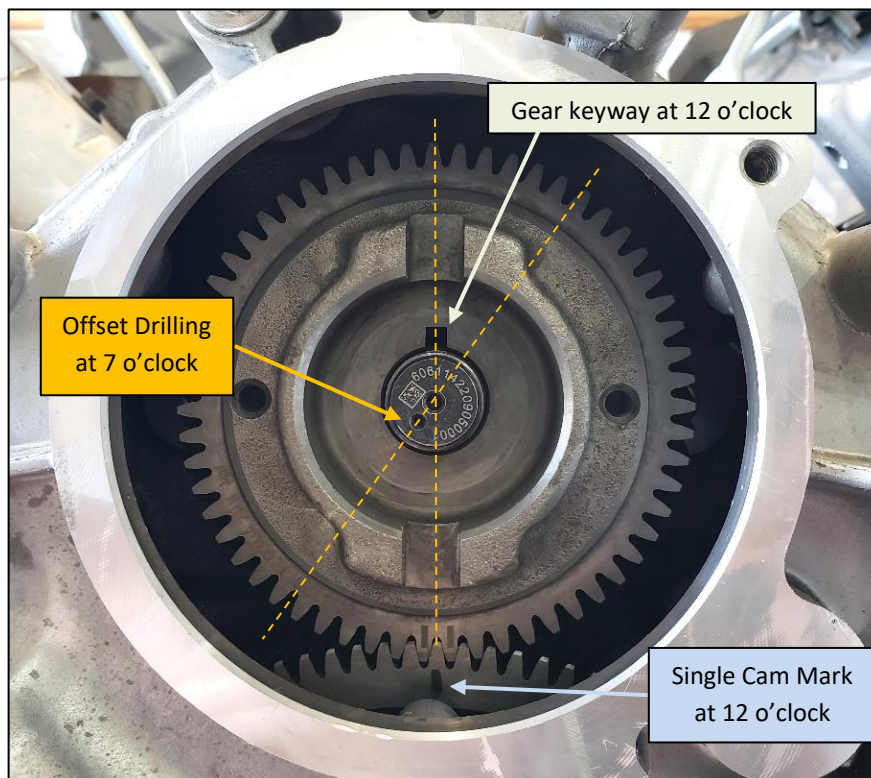

Figure 27: Fuel Pump Timing on Engine – Offset Hole Location

9. **Torque the OEM fuel pump drive gear nut to the DCR pump shaft to 60 lb-ft.**
- Hold the engine to prevent turning over if necessary. Typically, compression should hold the engine well enough to achieve 60 lb-ft.

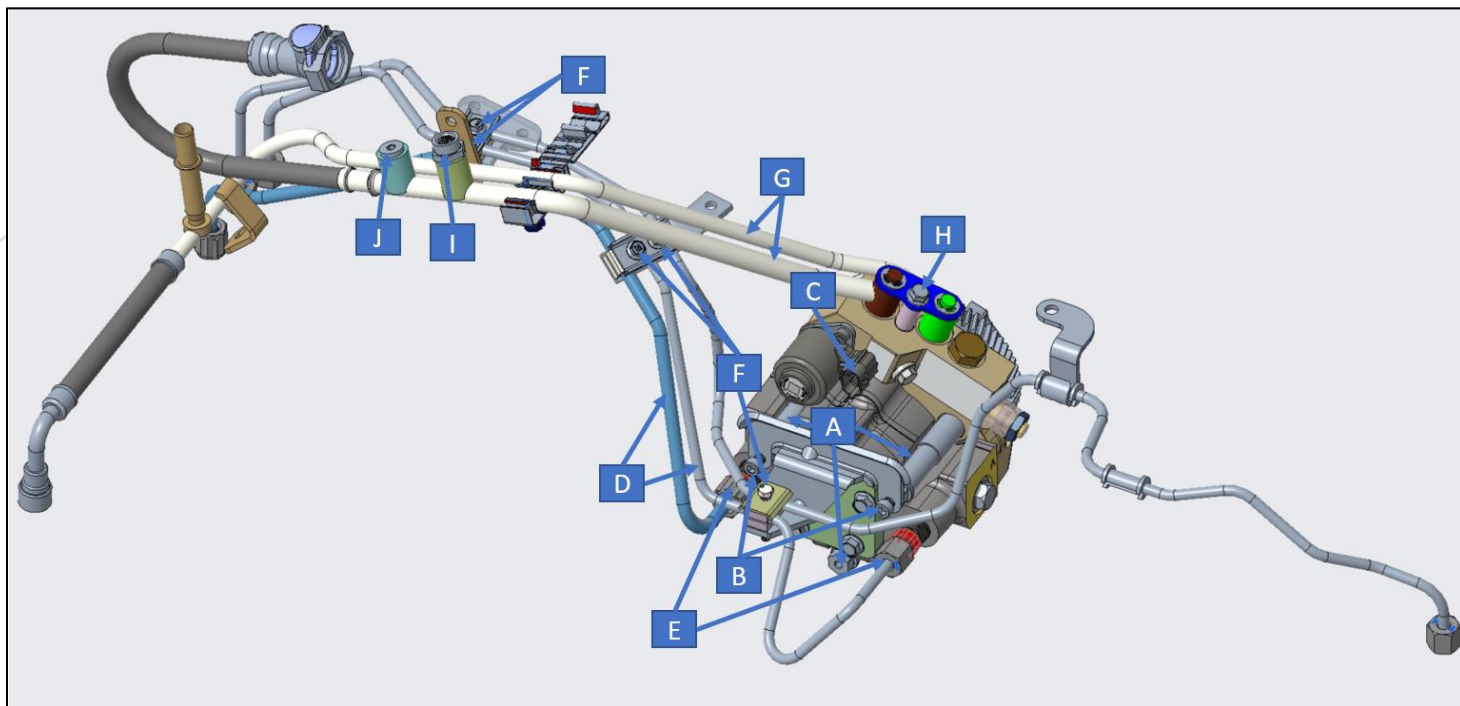

Figure 28: DCR Pump Assembly

10. Use the three OEM pump mounting stud / nuts to secure the pump in place (Labeled as A in Figure 28).
 - a. Torque all three to **18 lb-ft** starting with the bottom nut. **DO NOT over-torque these three OEM nuts.**
11. Referring to Figures 19, 26, and 28 (labeled as D), install the new high-pressure lines included in the kit.
 - a. Install the short driver-side high pressure line first, hand-tighten to the 3rd port on the driver's rail. Torque the nut on the pump to **26 lb-ft** prior to installing the longer passenger-side line.
 - b. Install the passenger-side high pressure line, hand-tighten to the 2nd port on the rail and torque to **26 lb-ft** at the pump.
 - c. Install the provided High-Pressure Fuel Line Tail Support Bracket to the OEM pump mounting nuts reusing the factory bolts (Labeled as B in Figure 28).
 - d. Move the OEM rail to rail crossover line into the proper position and hand-tighten to the first port on the driver's side fuel rail.
 - e. Install the bottom saddle on the pump's tail bracket that holds the crossover and passenger side lines.
 - f. Install the triple line saddle brackets above the driver's side valve cover and heat shield & hand-tighten.
 - g. Torque all remaining high pressure line nuts to **26 lb-ft** (Labeled as E). *3x Rail ports.*
 - g. Torque saddle brackets starting with the pump's tail bracket & all hold-down brackets to **89 lb-in**
12. Install the vacuum pump.
 - a. Install blue threadlocker on all four bolts.
 - b. Torque to **89 lb-in** (Figure 18).
13. Install the cooling fan hub mounting assembly. Torque the five mounting bolts to **18 lb-ft** (Figure 17).
 - a. Do not install the upper right bolt until after the fan is installed as it is used to hold the fan clutch bracket.

14. Install the cooling fan. Torque the fan nut to **98 lb-ft**.
15. Connect the cooling fan electrical connector & bracket to the fan hub using the remaining long bolt (Figure 16).
16. Install the accessory belt. Exercise caution to ensure the belt seats properly on all pulleys (Figure 15).
17. Connect the fuel control actuator (FCA / VCV) electrical connector to the pump (Labeled as C in Figure 26).
18. Depending on the model year of your truck, install the provided plug & adapter in the appropriate location in order to install the OEM sensors to the provided new low pressure line assembly:



Figure 29: 2011-2014 (OEM Sensors: no plugs or adapters)



Figure 30: 2015-2019 (Plug, Adapter + OEM Sensor)



Figure 31: 2020+ (Plug & OEM Sensor)



Figure 32: Reuse metal OEM bracket

19. Remove the plastic line clip and metal bracket from the OEM low pressure line assembly.
 - a. The metal bracket must be reused. A new plastic clip is provided in case the OEM clip is damaged. You can use either the OEM or the S&S provided plastic clip upon assembly.
20. Install the plastic clip and metal bracket to the new low pressure line assembly.
21. **LUBRICATE the O-Rings of the low-pressure line assembly with clean Engine Oil or O-Ring Lubricant.**
22. Install the supplied low-pressure line assembly into the DCR ports (Labeled as G in Figure 28).
 - a. Take care to ensure the o-rings are not cut during line assembly into the pump.
 - b. Install blue threadlocker on the line assembly to pump inlet OEM hold-down bolt (H in Figure 28)
 - c. Torque the fuel line assembly to pump inlet to **89 lb-in** using the OEM bolt.

- d. Torque the low-pressure line assembly mounting point at the Valve Cover to **89 lb-in**.
23. Referring to line A in Figure 11, make sure the return line is connected to the fuel rail securely.
 24. Connect the pump return line to the fuel tank return line mounted on the engine (Labeled as C in Figure 11).
 25. Connect the electrical connectors on the sensors of the new fuel supply lines (Labeled as I and J in Figure 28).
 26. If equipped, reinstall the black fiber cover on the driver's side valve cover.
 27. Install the intake manifolds. *(Both manifolds together for 2020+. Lower then Upper for 2011-2019).*
 - a. Torque 10mm head nuts/bolts to **18 lb-ft**. Torque 8mm head nuts/bolts to **89 lb-in**
 28. Connect the intake air throttle electrical connector.
 - a. On 2020+ the intake air throttle may have been unbolted to ease intake removal. Install if removed.
 29. Install the cold side intercooler pipe to the intake air throttle & intercooler (Labeled as L in Figure 8).
 30. Install the fuel filter housing and fuel filter (Labeled as G in Figure 8).
 - a. S&S recommends replacing the factory engine and chassis fuel filters when the DCR pump is installed.
 31. Connect the new S&S fuel supply line, OEM feed from tank, and Injector Return (17+ only) to the fuel filter.
 32. Install the crankcase ventilation hose to the lower intake manifold (Labeled as K in Figure 8).
 33. Install the hot side intercooler pipe (Turbo to intercooler pipe) (Labeled as J in Figure 8).
 34. Install the EGR bypass outlet pipe. Torque to **89 lb-in** (Labeled as I in Figure 8).
 35. Connect the EGR temp sensor located in the EGR bypass outlet pipe (Labeled as H in Figure 8).
 36. Install the upper intake manifold (Labeled as F in Figure 8).
 - a. Tighten the bolts in the sequence shown in Figure 10 for 2011-2019 model years
 - b. Torque to **89 lb-in**.
 37. Connect the transmission and oil dipstick to the upper intake manifold (Labeled as E in Figure 8).
 - a. Torque to **89 lb-in**.
 38. Connect the coolant and vacuum hose retainer to the upper intake manifold (Labeled as D in Figure 8).
 39. Connect the MAP sensor electrical connector on the top of the upper intake manifold (Labeled as C in Figure 8).
 40. Install the air filter intake and connect the MAF sensor (Labeled as B and A in Figure 8, respectively).
 41. Connect the negative battery leads to both batteries.
 42. **DO NOT attempt to start the truck without first priming the system by cycling the key multiple times.**
 - a. Turn the key to the ON position for 30 seconds. Cycle the key on (for 30 seconds each time) and off five times.
 - i. For vehicles equipped with a push-button start, press the button without your foot on the brake pedal.
 43. After cycling the key on and off at least five times for 30 second intervals each time, start the truck and inspect the high and low-pressure fuel fittings for leaks.