

INSTALLATION GUIDE

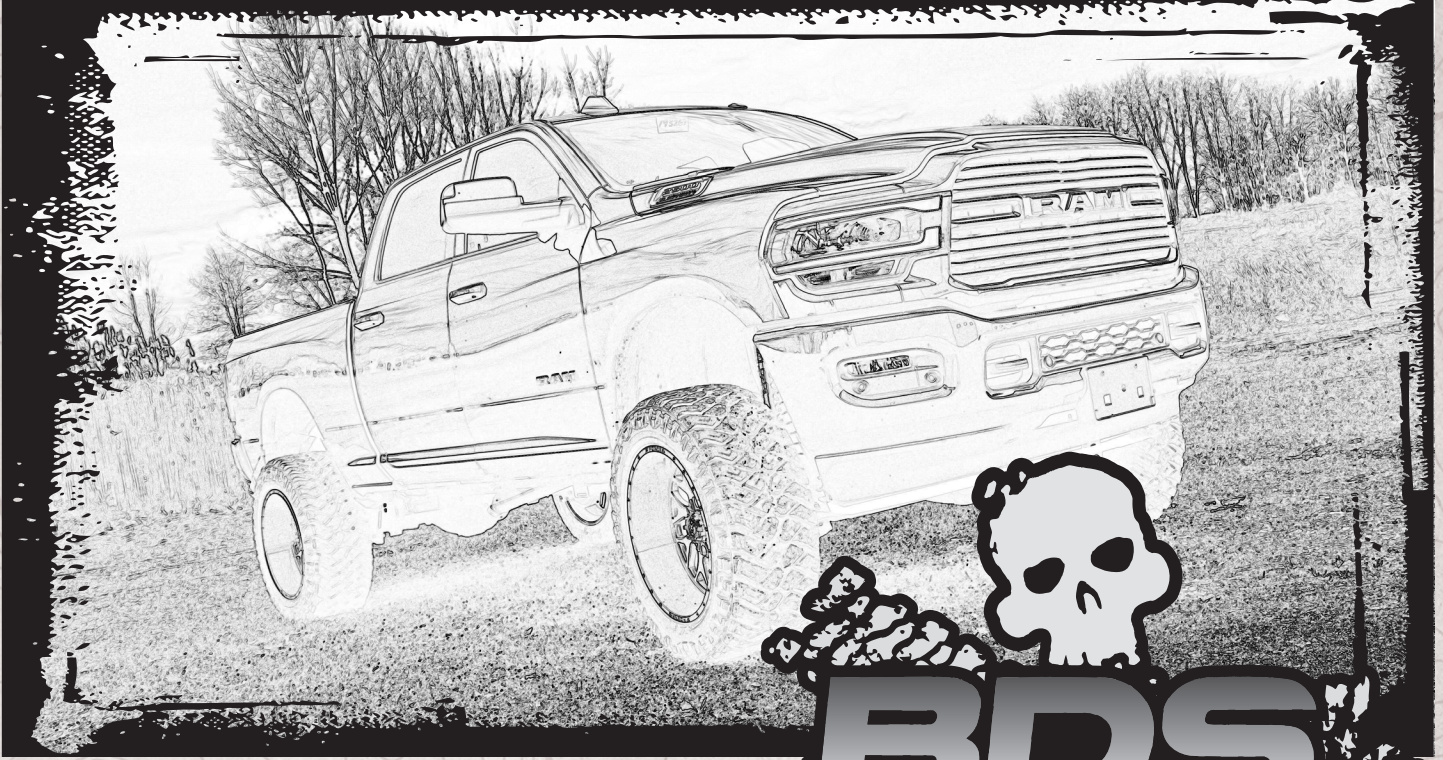

Part#: 122624, 122625, 122626,
122421



HARDCORE LIMITED LIFETIME WARRANTY

Transfer Case Indexing Ring Kit

Dodge 2500 | 2019-21

Dodge 3500 | 2019-21

Rev. 051622

491 W. Garfield Ave., Coldwater, MI 49036 • Phone: 517-279-2135

E-mail: tech-bds@ridefox.com

Read And Understand All Instructions And Warnings Prior To Installation Of System And Operation Of Vehicle.

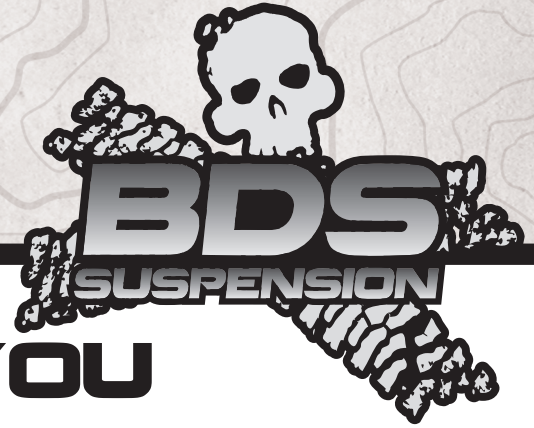

THANK YOU

Your truck is about to be fitted with the best suspension system on the market today. That means you will be driving the baddest looking truck in the neighborhood, and you'll have the warranty to ensure that it stays that way for years to come. Thank you for choosing BDS Suspension!

BEFORE YOU START

BDS Suspension Co. recommends this system be installed by a professional technician. In addition to these instructions, professional knowledge of disassembly/ reassembly procedures and post installation checks must be known.

BEFORE INSTALLATION

Special literature required: OE Service Manual for model/year of vehicle. Refer to manual for proper disassembly/reassembly procedures of OE and related components.

Adhere to recommendations when replacement fasteners, retainers and keepers are called out in the OE manual.

Larger rim and tire combinations may increase leverage on suspension, steering, and related components. When selecting combinations larger than OE, consider the additional stress you could be inducing on the OE and related components.

Post suspension system vehicles may experience drive line vibrations. Angles may require tuning, slider on shaft may require replacement, shafts may need to be lengthened or trued, and U-joints may need to be replaced.

Secure and properly block vehicle prior to installation of BDS Suspension components. Always wear safety glasses when using power tools.

If installation is to be performed without a hoist, BDS Suspension Co. recommends rear alterations first.

Due to payload options and initial ride height variances, the amount of lift is a base figure. Final ride height dimensions may vary in accordance to original vehicle attitude. Always measure the attitude prior to beginning installation.

FOR YOUR SAFETY

Certain BDS Suspension products are intended to improve off-road performance. Modifying your vehicle for off-road use may result in the vehicle handling differently than a factory equipped vehicle. Extreme care must be used to prevent loss of control or vehicle rollover. Failure to drive your modified vehicle safely may result in serious injury or death. BDS Suspension Co. does not recommend the combined use of suspension lifts, body lifts, or other lifting devices. You should never operate your modified vehicle under the influence of alcohol or drugs. Always drive your modified vehicle at reduced speeds to ensure your ability to control your vehicle under all driving conditions. Always wear your seat belt.

BEFORE YOU DRIVE

Check all fasteners for proper torque. Check to ensure for adequate clearance between all rotating, mobile, fixed, and heated members. Verify clearance between exhaust and brake lines, fuel lines, fuel tank, floor boards and wiring harness. Check steering gear for clearance. Test and inspect brake system.

Perform steering sweep to ensure front brake hoses have adequate slack and do not contact any rotating, mobile or heated members. Inspect rear brake hoses at full extension for adequate slack. Failure to perform hose check/ replacement may result in component failure. Longer replacement hoses, if needed can be purchased from a local parts supplier.

Perform head light check and adjustment.

Re-torque all fasteners after 500 miles. Always inspect fasteners and components during routine servicing.

CONTENTS OF YOUR KIT

Transmission Crossmember Kit		
Part #	Qty	Description
03835	1	2019 Dodge transmission x-member
02489	1	2013 Dodge Transmission mount
02490	6	2013 Dodge Transmission Spacers (1/4" thick)
099000	4	Zip Tie
099002	2	Push-in Zip Tie
944	1	Bolt Pack
487	6	1/2"-13 x 2" bolt, grade 5, yellow zinc
	12	1/2" SAE Washer, yellow zinc
	6	1/2"-13 Prevailing torque nut, yellow zinc
	1	Bolt Pack (Diesel Only)
	1	5/8"-11 x 8" Bolt, grade 8, yellow zinc
496	2	5/8" SAE Washer, yellow zinc
	1	5/8"-11 Prevailing torque nut, yellow zinc
	1	Bolt Pack
	1	Hose Clip
	1	6mm-1.00 Prevailing Torque Nut, Clear Zinc
	1	1/4" SAE Washer, Clear Zinc

Indexing Ring		
Part #	Qty	Description
A349	1	Indexing Ring Assembly (6-Bolt Only)
A351	1	Indexing Ring Assembly (8-Bolt Only)
03815	1	Transmission Output Spacer (8-Bolt Only)
UIS64x78x8	1	Output Seal (8-Bolt Only)
342701	1	Loctite
950	1	Bolt Pack (6-Bolt Only)
	6	10mm-1.50 x 30mm FHSCS (flat head socket cap screw)
	6	3/8"-24 hex nut
	6	3/8" NAS Spec. Washer
486	1	Bolt Pack (8-Bolt Only)
	8	10mm-1.50 x 30mm FHSCS (flat head socket cap screw)
	8	3/8"-24 hex Nut
	8	3/8" NAS Spec. Washer
357	1	Bolt Pack (Gas Only)
	8	8mm-1.25 x 60mm, Class 8.8, Clear Zinc
	8	5/6" SAE Washer, Clear Zinc
159	8	Air Tank Spacer
124	4	Power Hop Damper Spacer (122626 Only)
695	1	Bolt Pack (122626 Only)
	4	10mm-1.50 x 50mm Bolt, Class 10.9, Clear Zinc
	4	10mm Washer, Clear Zinc

TROUBLESHOOTING INFORMATION FOR YOUR VEHICLE

1. BDS Suspension recommends upgrading the transmission output shaft on vehicles with larger tires that will see heavy loads from other upgrades such as gearing, or performance tunes especially in high payload, heavy towing, or competition pulling applications.
2. Index ring alone may not eliminate all front driveline vibrations, caster cams at the axle may need to be adjusted to eliminated 4wd vibrations in rare circumstances.
3. Does not work with manual shift transfer cases.



**TECH
TIPS**

INSTALLATION INSTRUCTIONS

PRE INSTALLATION NOTES:

-A 8" lift Kit requires an aftermarket high angle front drive shaft. The after market drive shaft and provided indexing ring kit BDS122421 (8-bolt) or BDS122624 (6-bolt) must both be installed. It is recommended to install the full kit then measure for the aftermarket front driveshaft to ensure you order the right length. The kit was tested with a Drive Line Plus flange and driveshaft.

SPECIAL TOOLS

Transmission jack is highly recommended
CV Style Clamp Pliers

INSTALLATION INSTRUCTIONS

 **Tip** (8-Bolt Only) The transmission output seal is replaced with a seal available from BDS (UIS64x78x8), and is included in the kit. Do not try to reuse a seal. OE seal (6822 4227)

 **Tip** (Gas Models Only) Gas models will require extensive exhaust modification. This can be done after installation of the kit. But the front drive shaft will be required to be left out for the drive to the exhaust shop.

1. Park vehicle on clean, flat, and level surface. Block the rear wheels for safety.
2. Remove the transfer case skid plate if equipped, it will not be reinstalled.
3. Remove the rear driveshaft, retain hardware. Disconnect the front driveshaft from the transfer case. It will be necessary to remove the forward most clamp on the front drive shaft boot to access the retaining clip to slide the front drive shaft off. Replacement clamps are provided (Fig 1a, 1b, 1c)

FIGURE 1A

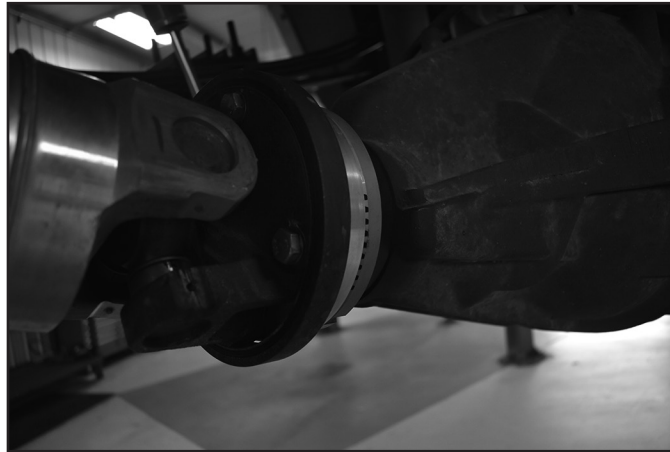

FIGURE 1B



FIGURE 1C



4. Disconnect the wire harness that controls the transfer case in preparation for removing the transfer case. (Fig 2b)
5. (Diesel Models Only) To make removing the transfer case easier. Support the DEF Tank cross member with a jack. Remove the 2 exhaust mount bolts that are on the top of the DEF crossmember. Remove all 6 bolts supporting the cross member to the frame. Lower the cross-member where the top bolt holes lines up with the lower hole on the frame. Reinsert a bolt into each mount to support the DEF Tank. (Fig 2a)

FIGURE 2A

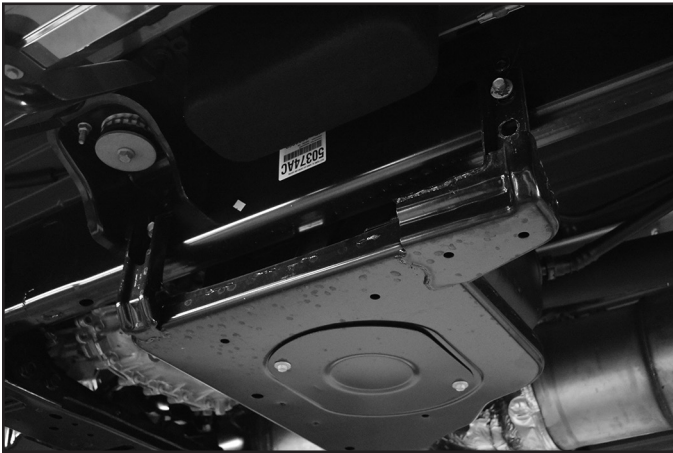
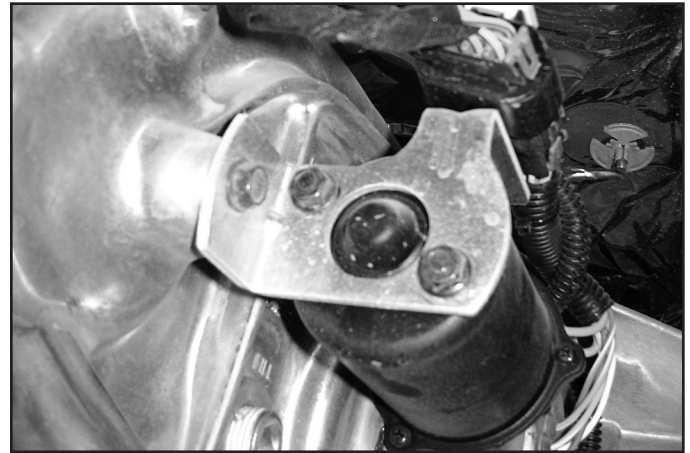
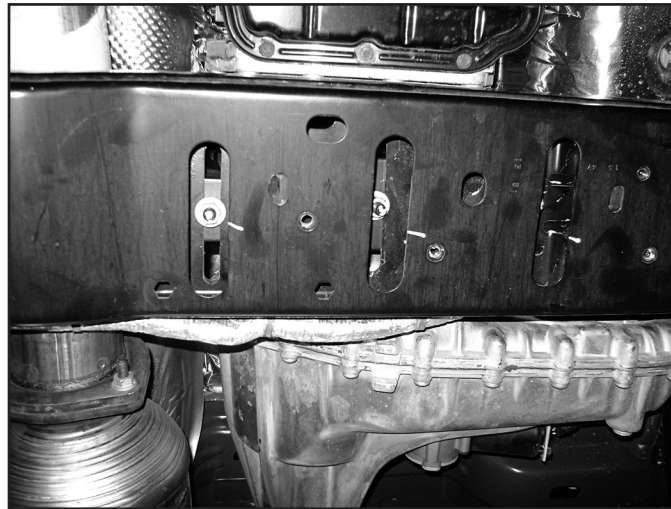

FIGURE 2B



6. Remove the 3 nuts that hold the transmission mount to the transmission crossmember. (Fig 3)

FIGURE 3



7. Diesel Models Only: Loosen the inner bolt on the passenger side for the transmission crossmember. Cut the Head off of the bolt so the bolt can be removed without removing the exhaust. Replacement hardware is provided. (Fig 4)

FIGURE 4



8. With the transmission well supported with a jack, remove the transmission crossmember and retain hardware.
9. If necessary to access the transfer case bolts, remove the transmission mount from the transmission. If equipped with a manual t-case & gas

engine the transmission mount must be removed. (Fig 5)

FIGURE 5

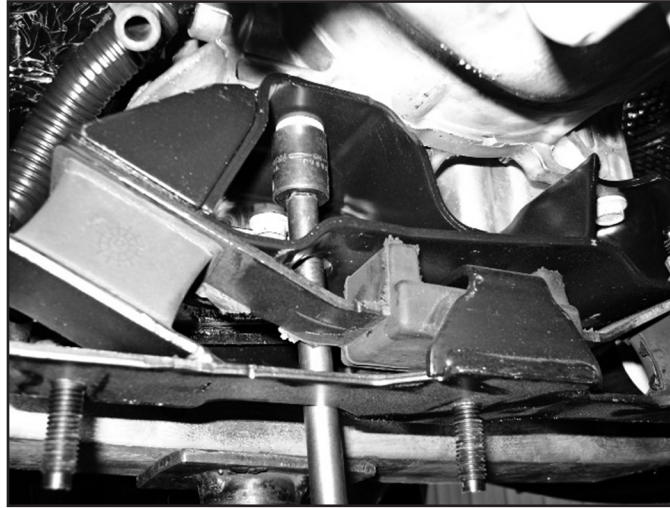

10. Remove the 6 or 8 nuts that hold the transfer case to the transmission and remove the transfer case from the vehicle. Use extra caution as the transfer case is very heavy.

Note: Do NOT remove the transmission output seal on a 6-Bolt!

11. On a 8-Bolt Aisin only: Remove the output seal. Install the Seal Spacer and then the provided seal (Fig 6B). Prelubricate the sealing surface with a little bit of oil. (Fig 6A) The seal will almost be flush with the housing when installed.

FIGURE 6A

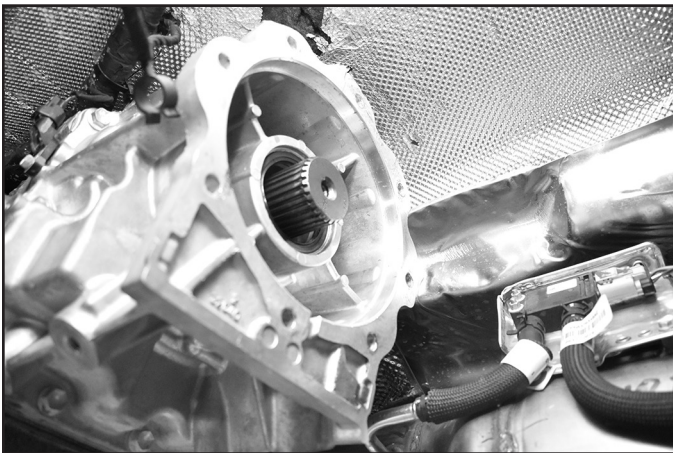
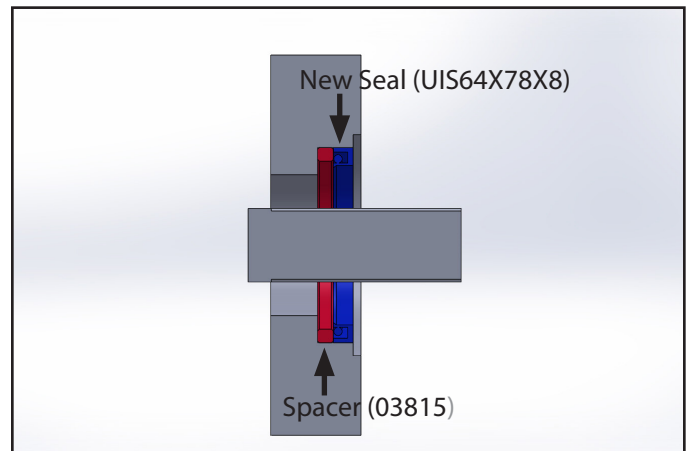

FIGURE 6B



12. Remove the studs on the transfer case by double nutting the studs. Place new indexing ring up to the transfer case. Attach with the provided 10mm flat head allen bolts.

Note there is a specific orientation on the 6-Bolt and the indexing ring will need to be rotated to get the proper hole alignment. (Figure 7a, 7b) Index Ring hardware is located in bolt pack 950 (6-bolt) or 486 (8-bolt).

FIGURE 7A



FIGURE 7B

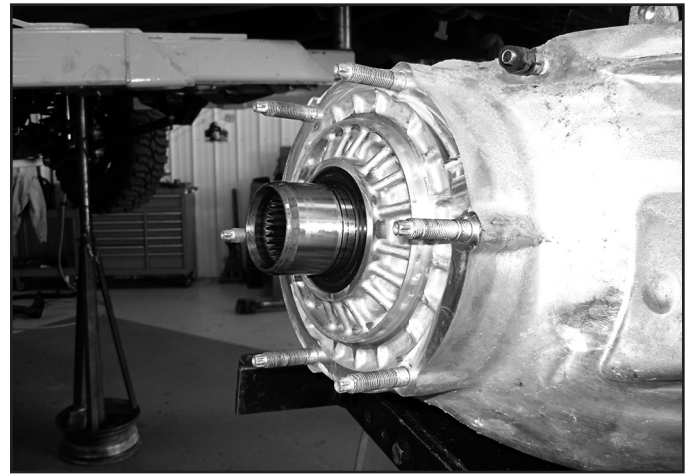
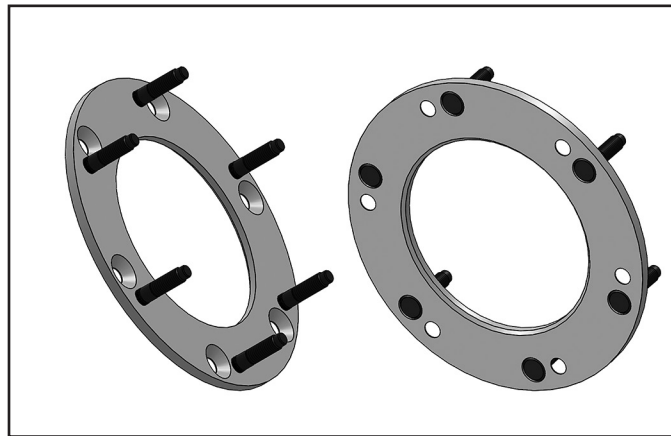

FIGURE 7C



13. Reinstall the transfer case and tighten with 3/8" fine thread nuts with washers. Loc-tite and tighten to 45 ft-lbs.

Note: This torque applies with the loc-tite still slightly damp and acting as a lubricant. The max recommended torque is 55 ft-lbs when rechecking hardware.

14. Disconnect the wire harness on the frame rail, reroute the wires to the transmission / transfer case above the front driveshaft. Use the provided Zip Ties and 6mm nut, 1/4" washer, with hose clip and fasten the harness to one of the heat shield studs under the body. Ensure that the harness is secure and won't touch exhaust or drive shafts. (Fig 8) Wire harness hardware is located in bolt pack 496

FIGURE 8



15. If Installing the Manual T-case Indexing Mount do so at this time by following the provided instructions. Then finish these instructions afterwards.

16. If the transmission mount was removed, reinstall with factory hardware.
17. Use 1/2" hardware in bolt pack 944 to secure the provided crossmember with crossmember transmission mount and 2 spacers in the front and 2 spacers in the rear. The taller end of the crossmember transmission mount will face towards the front of the vehicle. (Fig 9a) Install 1/2" hardware so bolts are facing down and leave loose. Reinstall crossmember into frame with factory hardware. Use the provided hardware to replace the cut bolt (diesel models only). (Fig 9b) Replacement crossmember hardware is located in bolt pack 487. Torque crossmember to frame bolts to 177ft-lbs. You can now tighten the 1/2" hardware.

FIGURE 9A

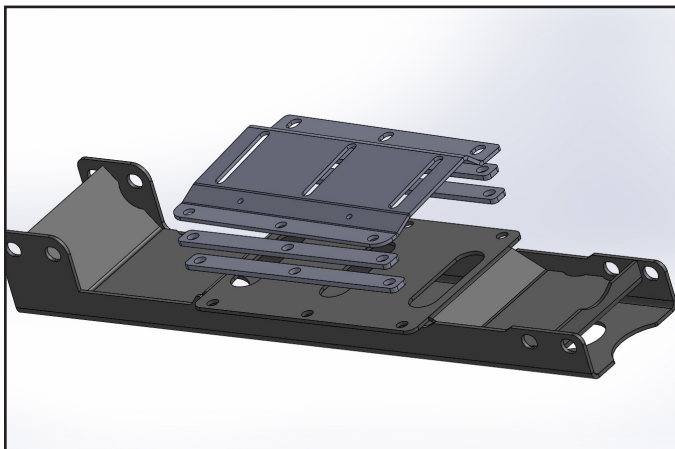

FIGURE 9B



18. Lower the transmission and bolt the transmission to the new crossmember with factory hardware, Torque to 45 ft-lbs. Torque the 1/2" hardware for the crossmember transmission mount and crossmember to 90 ft-lbs.
19. Reattach the front driveshaft to the Transfer case, new clamps are provided for the boot. Reattach the front drive shaft to the axle with OE hardware and loctite, torque to 85ft-lbs. rotate the front drive shaft to ensure it spins freely and clears exhaust and crossmember Use the provided boot clamps to resecure the drive shaft boot. (Fig 10)

NOTE: Gas Models Only: If you have not modified your exhaust yet you can leave the front drive shaft out of the vehicle to drive to an exhaust shop.

FIGURE 10

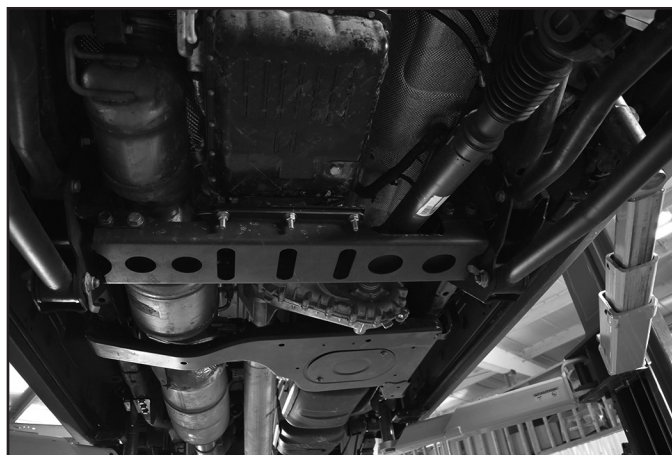

20. Reinstall rear driveshaft with factory hardware with loc-tite on threads. Tighten to 81 ft-lbs.
21. Resupport the DEF crossmember with a jack and remove the 3 bolts supporting it. Lift it back into the original position and bolt it into place with factory hardware, Torque to 35 ft-lbs. Bolt the exhaust mount back to the crossmember with factory hardware.
22. Recheck all hardware for proper torque. Check again after 500 miles and at regularly scheduled maintenance intervals.

REAR POWER HOP DAMPER

23. If your vehicle is equipped with a rear power hop damper and installing BDS012459 4.5" rear box kit. Reattach the rear power hop damper to the top of the rear axle housing with the 4 provided spacer sleeves (124) and 10mm bolts and washers from bolt pack 695 (Fig 11). Torque Bolts to 48 ft-lbs.

FIGURE 11



24. Recheck all hardware for proper torque. Check again after 500 miles and at regularly scheduled maintenance intervals.



WE WANT TO SEE YOUR RIDE!

Grab photos of your BDS-equipped truck in action and send them in for a chance to be featured. Send it in to our Bad Ass Rides customer gallery at bds-suspension.com/bar and post them on the BDS Fan Page on Facebook at facebook.com/BDSSuspensions. Don't forget about your BDS swag! BDS offers t-shirts, hoodies, decals and more available on the BDS website or through your local BDS distributor.

TIME TO HAVE SOME FUN

Thank you for choosing BDS Suspension.

For questions, technical support and warranty issues relating to this BDS Suspension product, please contact your distributor/installer before contacting BDS Suspension directly.