

Optimal Audio



USER GUIDE

Sub

Loudspeaker

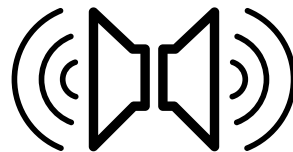

Loudspeakers

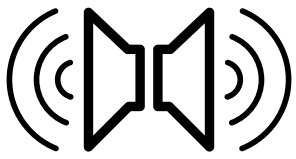

Loudspeakers

Sub

Loudspeakers

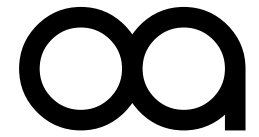

Optimal Audio

Congratulations on your choice of Optimal Audio for your latest sound system installation.

The Optimal Audio range of compatible audio zoners, amplifiers and loudspeakers are designed to work together simply and effectively. Our quick start guides will take you through the simple connection and set up procedure.

Optimal Audio Sub loudspeakers are designed to extend the low frequency performance of cuboid. When used in conjunction with the rest of the Optimal Audio eco-system Sub will surprise you with its punchy performance and professional aesthetic. This Quick Start Guide will help you get your Subs rigged, positioned and connected correctly.



USER GUIDE

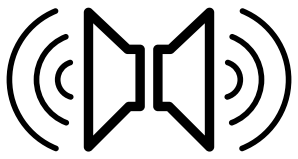

Loudspeakers

Sub

Loudspeakers

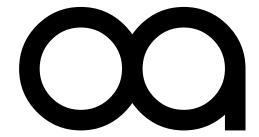

Optimal Audio

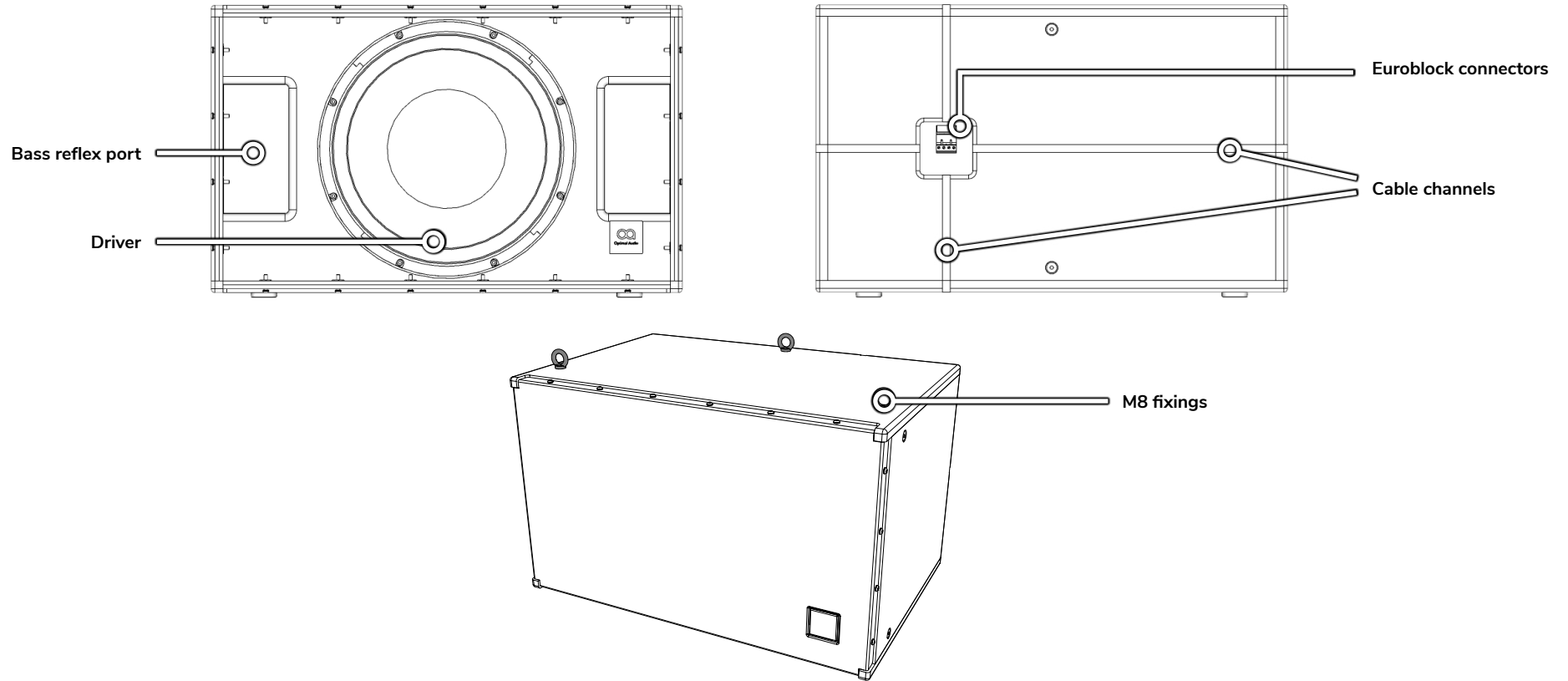

Sub 10 and Sub 15 are passive, low-frequency loudspeakers. Each model consists of a single driver loaded into a compact bass-reflex cabinet.

The loudspeaker has no internal electronic cross-over network and requires the use of a DSP preset to ensure the loudspeaker is fed with an appropriate signal. This can be achieved via external DSP processing or by using a dedicated preset in SmartAmp 30 (Sub 10 only).

USER GUIDE

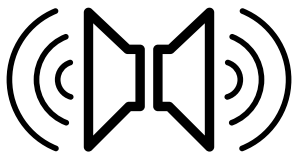

Loudspeakers

Sub

Loudspeakers

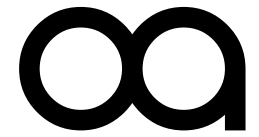

Optimal Audio

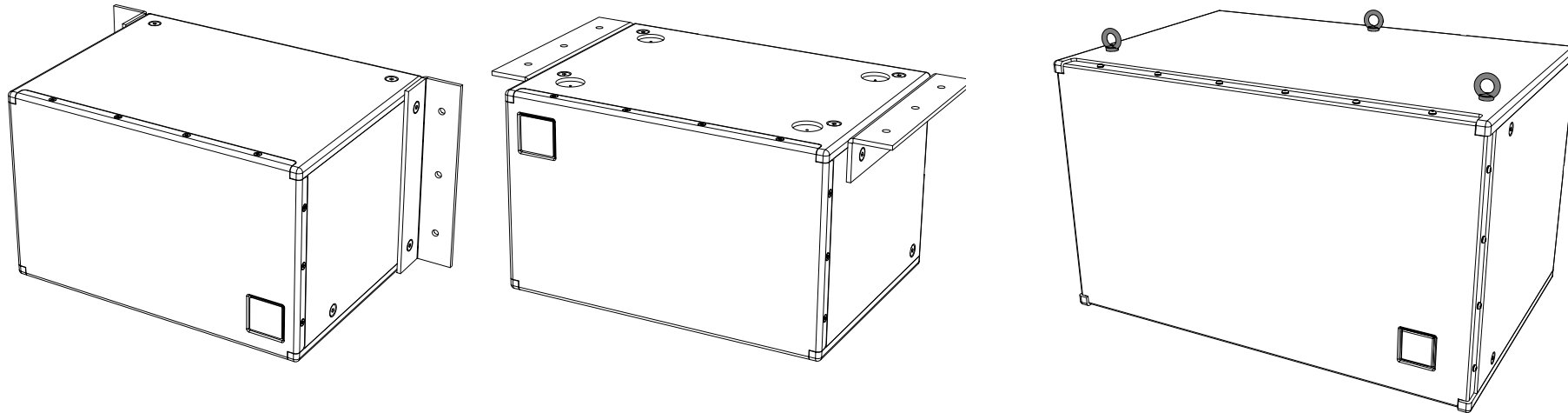

Sub loudspeakers are often mounted on the floor, and for good reason. Sub 10 is particularly suitable for placing discreetly under banquet seating. Floor mounting increases low-frequency efficiency due to the acoustic energy being reflected from the plane of the floor. The proximity of the cabinet to the floor, and the fact that low-frequency sound waves are long, means that the reflected energy couples with the direct output without cancellation, adding the acoustic power back to the wavefronts rather than it dispersing or reflecting back from more distant surfaces and causing cancellation.

Sub can be also mounted on a wall or suspended from a ceiling using the dedicated Sub Brackets, or M8 eyebolts and steel wire rope. These are available separately as Optimal Audio accessories. Be sure to connect up before mounting against a wall!

It is critical that the structure to which Sub is to be mounted is suitable for taking the weight of the loudspeaker/bracket assembly. It is highly recommended that a secondary safety fixing be fitted. This can be achieved using a suitable rated eyebolt and rated safety chain or steel wire rope fixed to an M8 eyebolt screwed into one of the M8 fittings.

USER GUIDE

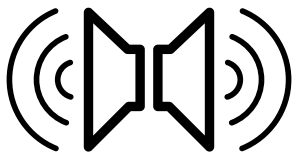

Loudspeakers

Sub

Loudspeakers



Sub Loudspeaker alignment

To get the best out of your Optimal Audio loudspeaker system, it's well worth considering how best to align Subs with your Cuboids, depending on the relative placement of the sub-bass and higher frequency elements of the system.

If you are able to deploy Sub and Cuboid in close proximity to each other, this is the best possible option as they essentially work together as one speaker - Sub extending the low frequency response. Ensure the grilles are perfectly aligned with each other to get the best coupling.

In many cases, Cuboid will be wall or ceiling mounted and Sub placed on the floor. From the point of view of the ideal listening position, the two cabinets are not the same distance away, which can lead to destructive interference at cross-over frequency at worst, and loss of transient detail and low-frequency punch.

The system can be optimised by applying delay to the cabinet that is closer to a given listening position, usually halfway in to the coverage area. This will always be a compromise everywhere else, but to a much smaller degree if good alignment is in place.

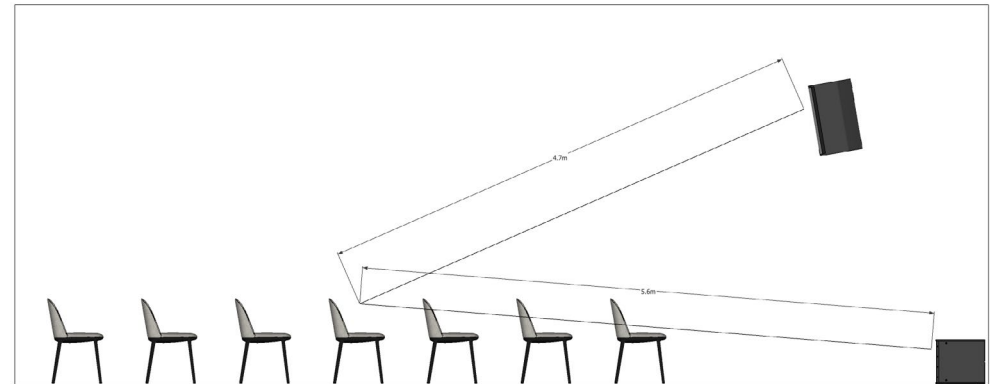

In this example, the Cuboid has been wall-mounted, and Sub is on the floor. Decide on a Recommended Listening Position (RLP), usually halfway through the coverage area. Measure the distance to each speaker.

Here, Cuboid is 0.9m closer than Sub.

Using the formula distance/speed of sound (334m/s @ 20 degrees C), Cuboid should be delayed by $0.9/334 = 2.6$ milliseconds.

USER GUIDE

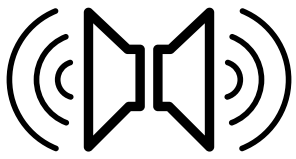

Loudspeakers

Sub

Loudspeakers



Connecting Up

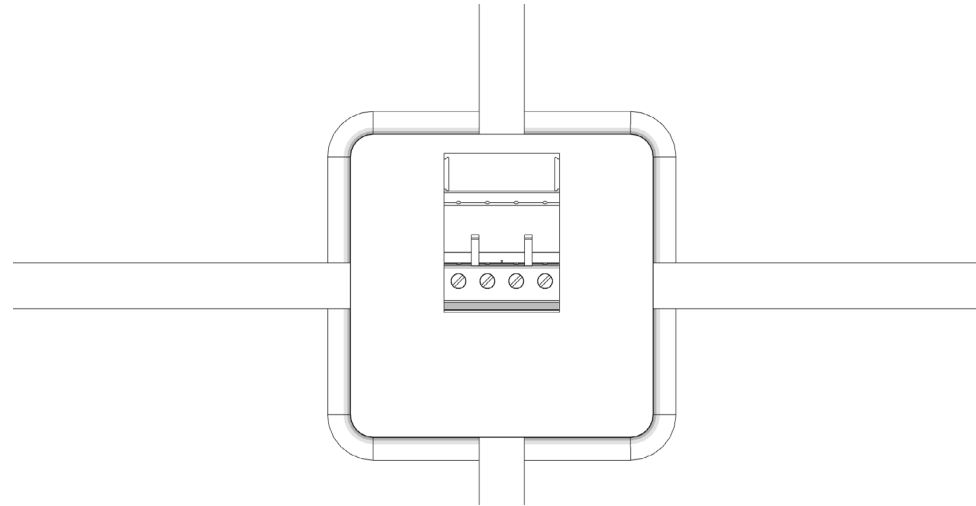

All Sub loudspeakers are fitted with Euroblock connectors. These have two pairs of terminals.

Sub uses only 1 and 2. Pins 3 & 4 are linked to pins 1 & 2 respectively, and provide an easy way of connecting to a further Sub. No more than two Subs should be connected to a single amplifier channel.

For connection, we recommend using a flexible cable with a minimum cross-sectional area of 2.5mm². When wiring loudspeaker cables be careful to observe the correct polarity of the cable and connector at both ends.

USER GUIDE

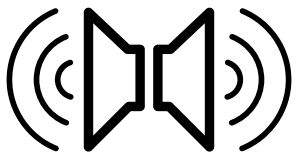

Loudspeakers

Sub
Loudspeakers

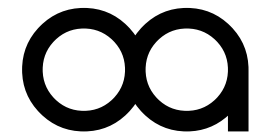

Optimal Audio

Matching Speakers and Amplifiers

To get the best from your loudspeakers, it's important to make sure the amplifier you are using is up to the job. Several factors have to be considered, and it's worth clarifying what they mean and how they affect the performance of a loudspeaker.

Loudspeakers tend to be quantified using Watts, but this is purely a measure of the amount of power a loudspeaker can take at its input over time, and not necessarily a measurement of how loud it might go.

Optimal Audio loudspeaker power handling is therefore quoted as Watts (AES) and Watts (Peak), Peak delivering 6dB(SPL) acoustic output higher than AES (AES2-2012 standard) and referring to the loudest transients a loudspeaker can handle without distortion.

In Watts, this means that the peak power handling of a Sub 10 for example is 1000W, four times its continuous power handling of 250W.

So, give a Sub 10 250W of continuous power and you will get 121dB(SPL) out of it if you are standing 1m away from it. It will however be able to deliver transient peaks in the audio signal at 127dB(SPL(@1m, half space)) without distortion or damage.

What this all means is that for the best performance from your loudspeaker, make sure you have an amplifier that is capable of delivering more than a loudspeaker's rated AES power handling ability at the nominal impedance of the loudspeaker – 8 Ohms in the case of all Sub speakers. A 250W amplifier will deliver 121dB(SPL) from a Sub 10 and nothing more, but a more powerful amplifier will have the headroom to deliver short musical transients at higher levels, thereby ensuring that faithful reproduction of the program material is maintained.

USER GUIDE

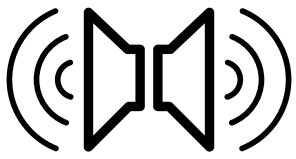

Loudspeakers

Sub

Loudspeakers



Specifications

	Sub 10	Sub 15
TYPE	Sub-bass loudspeaker	Sub-bass loudspeaker
FREQUENCY RESPONSE (with preset)	50Hz - 150Hz ± 3dB -10dB @42Hz	45Hz - 150Hz ± 3dB -10dB @40Hz
DRIVERS	LF: 10" (250mm)	LF: 15" (380mm)
RATED POWER	250W (AES) 1000W (peak)	500W (AES) 2000W (peak)
NOMINAL IMPEDANCE	8Ω	8Ω
SENSITIVITY (1W/1m)	97dB (half space)	102dB (half space)
MAXIMUM SPL	121dB (cont), 127dB (peak) (half space)	129dB (cont), 135dB (peak) (half space)
CROSSOVER	n/a	n/a
DISPERSION (-6dB)	n/a	n/a
ENCLOSURE	Plywood	Plywood
FINISH	Black textured paint	Black textured paint
PROTECTIVE GRILLE	Perforated steel	Perforated steel
CONNECTORS	Euroblock type	Euroblock type
PIN CONNECTIONS (INPUT)	1+ 1-	1+ 1-
FITTINGS	12 x M8, inset bolts	12 x M8, inset bolts
DIMENSIONS	(W) 470mm x (H) 297mm x (D) 353mm (W) 18.50" x (H) 11.7" x (D) 13.9"	(W) 716mm x (H) 443mm x (D) 480mm (W) 28.19" x (H) 17.4" x (D) 18.9"
WEIGHT	12.9kg (28.4lb)	34.3kg (75.6lb)
ACCESSORIES (available separately)	Sub bracket (pair), M8 eye bolt	M8 eye bolt

USER GUIDE

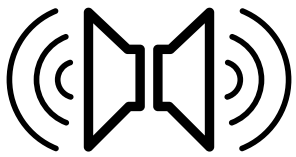

Loudspeakers

Sub

Loudspeakers



WARNING!

DO NOT EXPOSE THIS EQUIPMENT TO RAIN OR MOISTURE

This symbol is intended to alert the user to the presence of important operating and maintenance (servicing) instructions in the literature accompanying the appliance.



CAUTION

**RISK OF ELECTRIC SHOCK
DO NOT OPEN**

This symbol is intended to alert the user to the presence of uninsulated "dangerous voltage" within the product's enclosure that may be of **sufficient magnitude to constitute a risk** of electric shock to persons.

Important Safety Instructions

1. Read these instructions.
2. Keep these instructions.
3. Heed all warnings.
4. Follow all instructions.
5. Do not use this apparatus near water.
6. Clean only with a dry cloth.
7. Do not block any ventilation opening. Install in accordance with the manufacturer's instructions.
8. Do not install near any heat sources such as radiators, heat registers, stoves, or other apparatus (including amplifiers) that produce heat.
9. Protect the loudspeaker cable from being walked on or pinched particularly at plugs, convenience receptacles, and the point where they exit from the apparatus.
10. Do not unplug the unit by pulling on the loudspeaker cable, use the plug.
11. Refer all servicing to qualified service personnel. Servicing is required when the apparatus has been damaged in any way, such as liquid has been spilled or objects have fallen into the apparatus, the apparatus has been exposed to rain or moisture, does not operate normally, or has been dropped.
12. The apparatus shall not be exposed to dripping or splashing and no objects filled with liquids, such as vases, shall be placed on the apparatus.
13. Do not remove any covers, loosen any fixings or allow items to enter any aperture.
14. Ensure the loudspeaker is mounted with appropriately sized fixings of suitable load bearing capacity
15. Always ensure a secondary safety fixing is used where loudspeakers are mounted overhead.

USER GUIDE

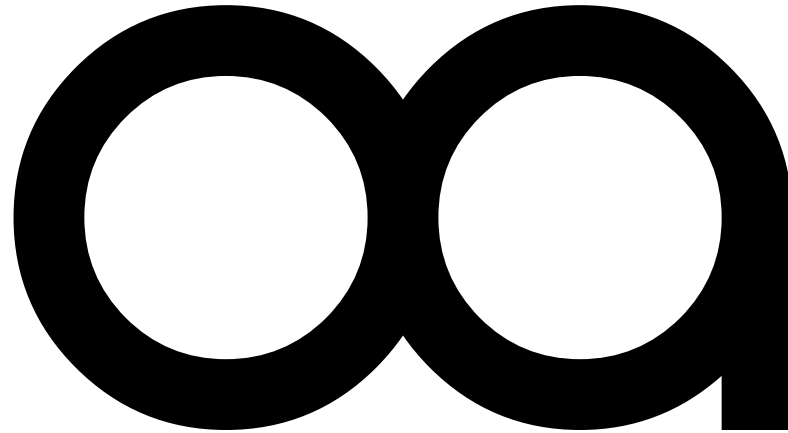

Relax, It's Optimal Audio.

optimal-audio.co.uk

Optimal Audio Group Ltd.
Century Point, Halifax Road,
Cressex Business Park,
High Wycombe,
Buckinghamshire,
HP12 3SL