

Operation Manual

Digital Amplifier
MA-110/110N



interM

Welcome

A personal welcome to you from the management and employees of Inter-M

All of the co-workers here at Inter-M are dedicated to providing excellent products with inherently good value, and we are delighted you have purchased one of our products.

We sincerely trust this product will provide years of satisfactory service, but if anything is not to your complete satisfaction, we will endeavor to make things right.

Welcome to Inter-M, and thank you for becoming part of our worldwide extended family!



WARNING

To prevent fire or shock hazard, do not expose the unit to rain or moisture.



This symbol is intended to alert the user to the presence of uninsulated "dangerous voltage" within the product's enclosure that may be of sufficient magnitude to constitute a risk of electric shock to persons.



This symbol is intended to alert the user to the presence of important operation and maintenance (servicing) instructions in the literature accompanying the appliance.

Caution: To prevent electric shock do not use this (polarized) plug with an extension cord, receptacle or other outlet unless the blades can be fully inserted to prevent blade exposure.

Attentions: Pour prévenir les chocs électriques ne pas utiliser cette fiche polarisée avec un prolongateur, une prise de courant on une autre sortie de courant, sauf si les lames peuvent être insérées à fond sans en laisser aucune partie à découvert.
Pour deconnecter complètement l'appareil du reseau d'alimentation. deconnecter le cordon d'alimentation de la prise murale.
La prise du reseau d'alimentation doit demeurer aisement accessible.

*WARNING FOR YOUR PROTECTION PLEASE READ THE FOLLOWING-WATER AND MOISTURE: Unit should not be used near water(e.g. near a bathtub, washbowl, kitchen sink, laundry tub, in a wet basement, or near a swimming pool, etc). Care should be taken so than objects do not fall and liquids are not spilled into the enclosure through openings.

*CLASS 2 WIRING (Adjacent to speaker terminal): The speaker output of this apparatus can exceed 10 Watts and could be a shock injury. Connection to speakers should be performed by a skilled person.

*Do not install this equipment in a confined space such as a book case or similar unit.

*Warning : To reduce the risk of fire or electric shock, do not expose this apparatus to rain or moisture and objects filled with liquids, such as vases, should not be placed on this apparatus.

*This apparatus shall be connected to a mains socket outlet with a protective earthing connection.

*To completely disconnect this apparatus from the AC mains, disconnect the power supply cord plug from the AC receptacle.

*The mains plug of the power supply cord shall remain readily accessible.

CAUTION

*These servicing instructions are for use by qualified service personnel only. To reduce the risk of electric shock, do not perform any servicing other than that contained in the operating instructions unless you are qualified to do so.

NOTE

*This equipment has been tested and found to comply with the limits for a Class A digital device, pursuant to Part 15 of the FCC Rules. These limits are designed to provide reasonable protection against harmful interference when the equipment is operated in a commercial environment. This equipment generates, uses, and can radiate radio frequency energy and, if not installed and used in accordance with the instruction manual, may cause harmful interference to radio communications. Operation of this equipment in a residential area is likely to cause harmful interference in which case the user will be required to correct the interference at his own expense.

Contents

Unpacking	2
Installation	
Environment.....	2
Important Safety Instructions.....	2
Features	3
Operation	3
Front Panel	4
Rear Panel	5
Connecting Speakers	7
Applications	8
Block Diagram	12
Specifications	14
Service	
Procedures.....	16
Schematic.....	16
Parts List	16
Variations and Options	16
Warranty	16

Unpacking

Although your MA-110/110N is neither complicated nor difficult to operate, we recommend you take a few minutes to read this brief manual and familiarize yourself with the important information regarding product features, setup and operation.

As with most electronic devices, we strongly recommend you retain the original packaging. In the unlikely event the product must be returned for servicing, the original packaging (or reasonable equivalent) is required.

Installation

Environment

Never place this product in an environment which could alter its performance or reduce its service life. Such environments usually include high levels of heat, dust, moisture, and vibration.

IMPORTANT SAFETY INSTRUCTIONS

1. Read these instructions.
2. Keep these instructions.
3. Heed all warnings.
4. Follow all instructions.
5. Do not use this apparatus near water.
6. Clean only with dry cloth.
7. Do not block any ventilation openings. Install in accordance with the manufacturer's instructions.
8. Do not install near any heat sources such as radiators, heat registers, stoves, or other apparatus (including amplifiers) that produce heat.
9. Do not defeat the safety purpose of the polarized or grounding-type plug. A polarized plug has two blades with one wider than the other. A grounding type plug has two blades and a third grounding prong. The wide blade or the third prong are provided for your safety. If the provided plug does not fit into your outlet, consult an electrician for replacement of the obsolete outlet.
10. Protect the power cord from being walked on or pinched particularly at plugs, convenience receptacles, and the point where they exit from the apparatus.
11. Only use attachments/accessories specified by the manufacturer.
12. Use only with the cart, stand, tripod, bracket, or table specified by the manufacturer, or sold with the apparatus. When a cart is used, use caution when moving the cart/apparatus combination to avoid injury from tip-over.
13. Unplug this apparatus during lightning storms or when unused for long periods of time.
14. Refer all servicing to qualified service personnel. Servicing is required when the apparatus has been damaged in any way, such as power-supply cord or plug is damaged, liquid has been spilled or objects have fallen into the apparatus, the apparatus has been exposed to rain or moisture, does not operate normally, or has been dropped.



Features

- **COMPACT DESIGN**
Easy to install and operate with compact design of 1U size and functions.
- **DIGITAL AMPLIFIER CIRCUIT**
Take up the Digital Amplifier Circuit with High efficiency of the rated power 100W, High reliability, Low weight and Low temperature.
- **SUPPLY POWER BY SMPS**
Take up SMPS (Switching Mode Power Supply) for Low electric power and Low weight.
- **VARIOUS INPUT CONTROL FUNCTION**
Control the each input channel level using the sound control volume of INPUT 1~3.
- **INPUT SIGNAL LEDS**
Easy to check the inputted signal to INPUT 1~3.
- **TONE CONTROL FUNCTION**
Separate Bass(100Hz) and Treble(10kHz) controls to tailor your sound.
Easy to control the tone due to user frequency which is including bass and treble.
- **ADDITIONAL FUNCTIONS**
Easy to use with the various additional functions including power of phantom MIC, TEL IN.
- **PRIORITY MUTING**
Adopted the priority muting function which control the other input signal, by TEL IN and INPUT 1 signal and external MUTE.
- **EXTERNAL MUTE FUNCTION**
Be able to use external mute when you want to cut off the unit's output signal from the external equipment.

Operation

1. Before you plug the power cord to AC outlet, please set the power switch OFF, Tone Control center, and volume level minimum.
2. Please make sure the speakers and input jacks are properly connected before turn the power switch on.
3. Be sure the AC power is correct voltage before you plug into the power cord.
4. Please push the power switch, then the power input LED is on and the unit will be operated.
5. Please use your own with adjustment the volume using each input volume and master volume, the tone using the tone control.

Front Panel

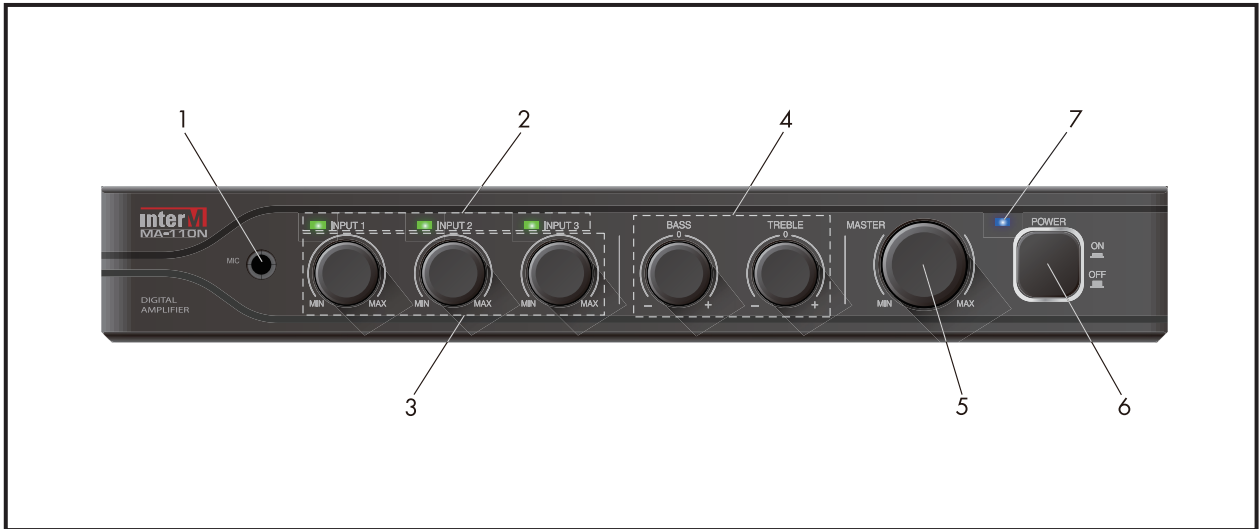

1. MIC INPUT JACK FOR INPUT 1 (6.3ø Phone Jack, Balanced)

This is a 6.3ø jack on the front channel that is very useful for connecting dynamic microphone. When microphone plugged to the jack, it overrides all the input signals.

2. INPUT SIGNAL LED

These green LEDs flash when signal is present and the input level control to input 1~3 is turned up.

3. INPUT VOLUME

These adjust the Mixing level of input signal of 1~3.

4. TONE CONTROL

These control the bass(100Hz) and treble(10kHz) of the main output signal by $\pm 10\text{dB}$.

5. MASTER VOLUME

This controls the main output level.

6. POWER SWITCH

This switch turns the power on and off.

7. POWER LED

This LED is on when the amplifier is active and powered.

Rear Panel

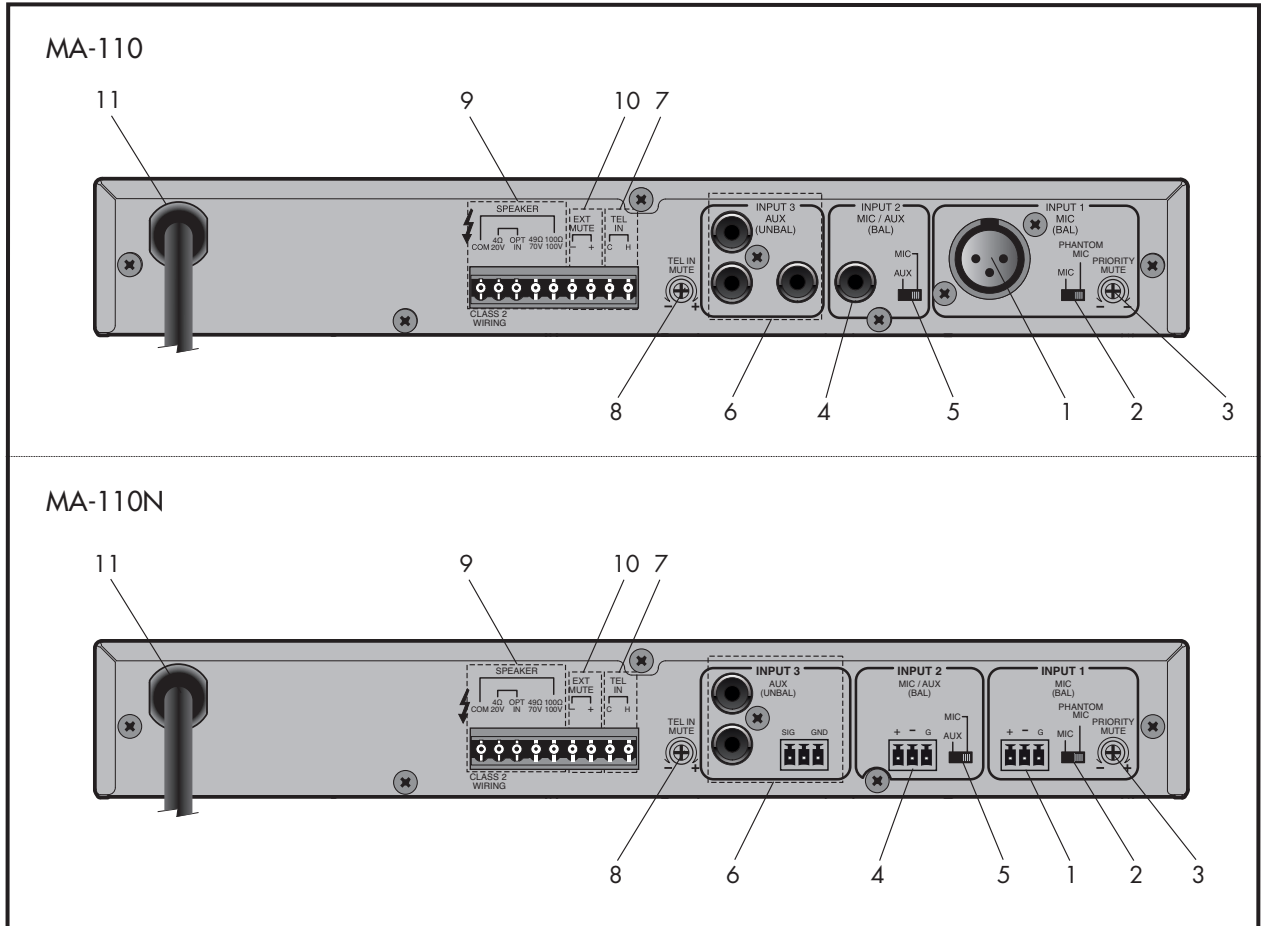

1. INPUT 1 TERMINAL

This terminal is for microphone. When connecting to balanced signal, be sure to use balanced cable and please refer to the following picture when using unbalanced cable.

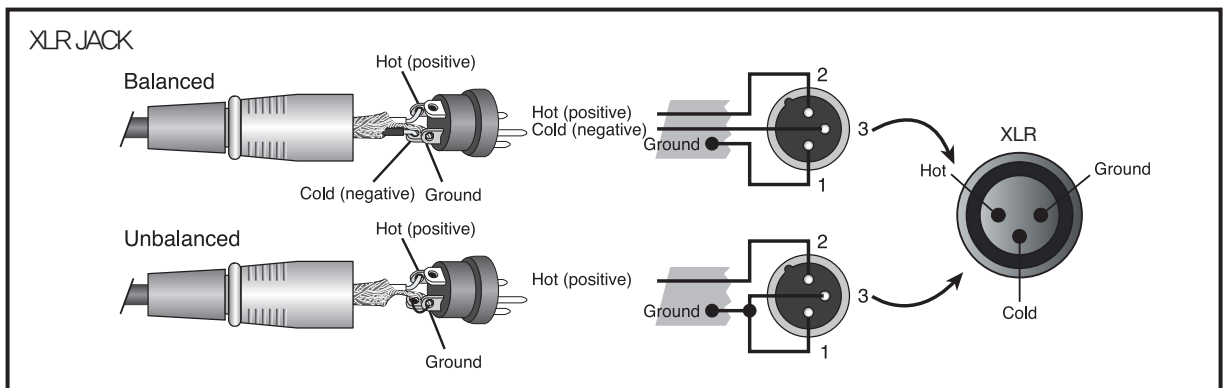

※ Locate "Phantom microphone" switch to MIC when using unbalanced cable.

- EURO Terminal

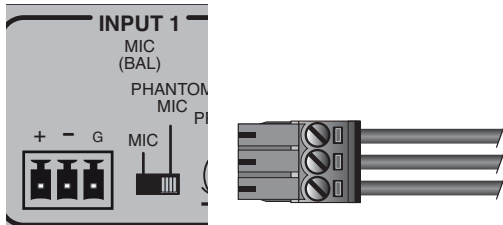

(Balanced Cable)
Use 3.5mm 3P Euro terminal.

2. SELECT SWITCH OF INPUT 1 PHANTOM MIC

This is the switch to select types of microphones. Be able to use either DYNAMIC MIC or CONDENSER MIC, and the phantom power of +15V is supplied when using the condenser microphone. MIC: For general dynamic microphones PHANTOM MIC: For condenser microphones

3. THE PRIORITY CONTROL VOLUME OF INPUT 1

Input 1 has priority over input 2~3. Output level of input 2~3 lowers when signal is present on input 1. Priority mute control volume adjusts the output level on input 2~3.

4. INPUT 2 TERMINAL

This terminal is for such devices as microphone, computer, CD player, and DVD player. Please refer to the following picture about the suitable cables. 6.3 ϕ Phone Jack

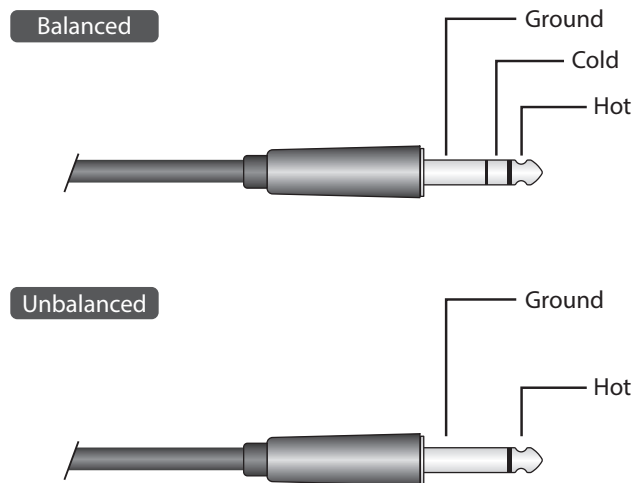

※ Please refer to Euro terminal cable manual of input 1 for MA-110N.

5. INPUT 2 LEVEL SELECT SWITCH

This is the switch to adjust level of input 2.

- MIC : For microphones

6. INPUT 3 TERMINAL

AUX input terminal for such devices as microphone, computer, CD player, and DVD player. Please refer to the following picture about the suitable cables.

- RCA JACK

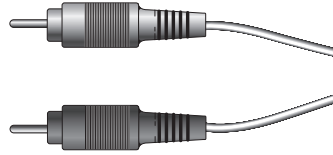

(Unbalanced Cable)
Use stereo audio pin cable.

'Y' cable is needed when connecting to computers.

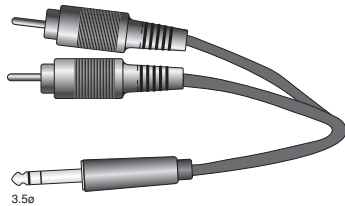
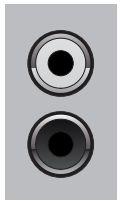

(Unbalanced Cable)
Use stereo audio pin Y.

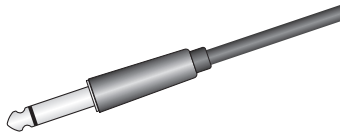
- 6.3 ϕ Phone Jack

(Unbalanced Cable)
Use 6.3 ϕ Phone jack cable.

- EURO Terminal

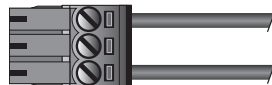
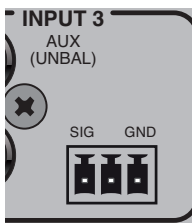

(Unbalanced Cable)
Use 3.5mm 3P Euro Terminal cable.

7. TEL IN TERMINAL

This is the audio input terminal of PBX that can be controlled with master volume control.

8. TEL IN PRIORITY CONTROL VOLUME

TEL IN input signal can be the top priority. TEL IN input has priority over input 1~3. Output level of input 1~3 falls when signal is present on TEL IN. TEL IN mute control volume adjusts the level of output falling on input 2~3.

9. SPEAKER OUTPUT TERMINAL

This is the terminal for speakers. 4 Ω , 70V(49 Ω), 100V(100 Ω) cannot be used at the same time. It may cause overload and malfunction.

※ Connecting Speakers

Before connecting speakers to MA-110/110N unit, be sure to disconnect the AC power cable.

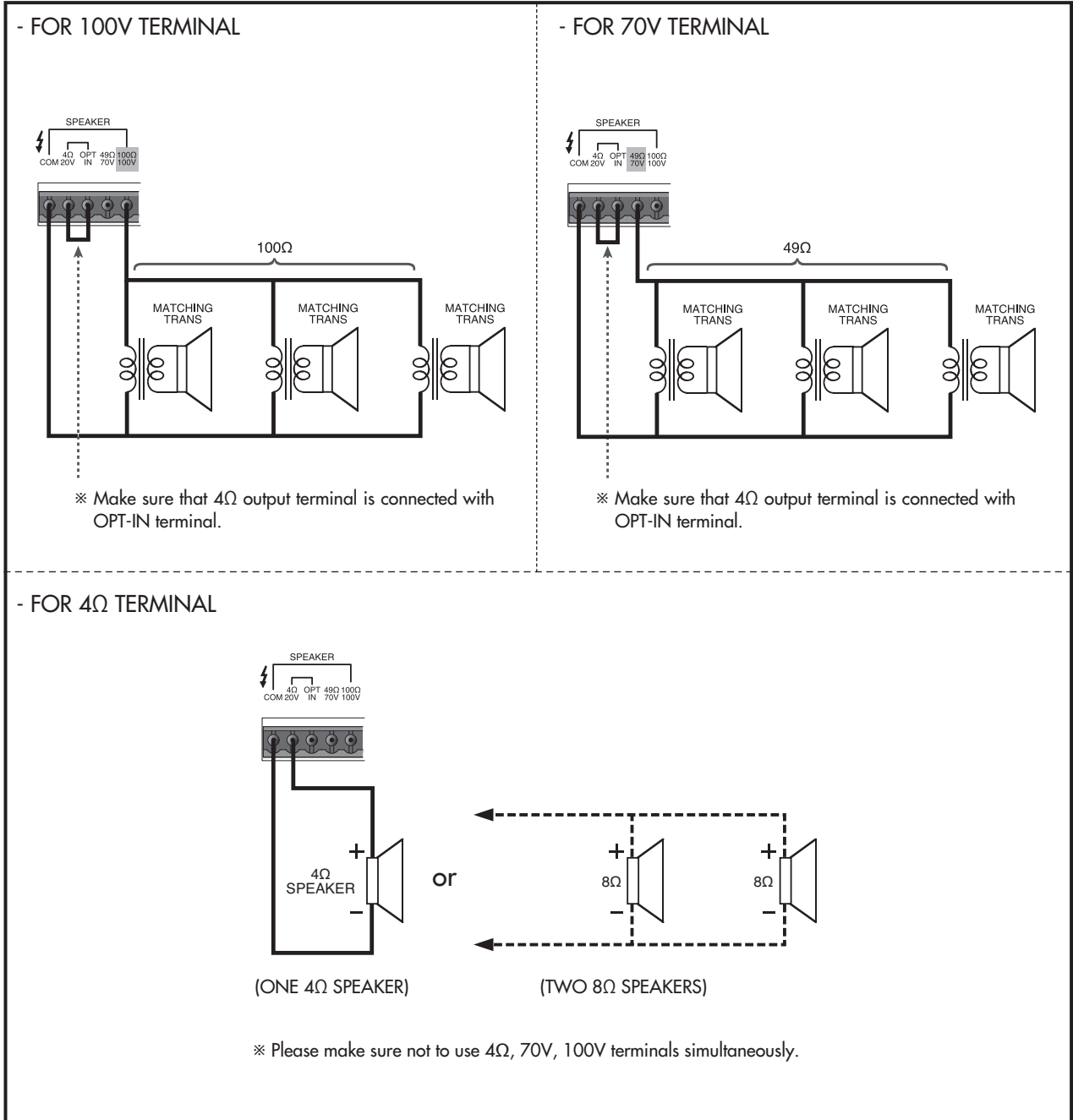

- NOTE :
1. Make certain that the total impedance is not less than the rated impedance indicated.
 2. Please make sure not to use 4Ω, 70V, 100V terminals simultaneously.
 3. If you're just dealing with the high impedance terminal, then make sure that 4Ω output terminal is connected with OPT-IN terminal.

10. EXTERNAL MUTE CONTROL TERMINAL

Connect +, - terminals externally to mute the output signal.

11. AC POWER CORD

This is the AC cord for connecting power. Do not bend, pull, twist, heat and cut by force. It may cause electric shock.

Applications

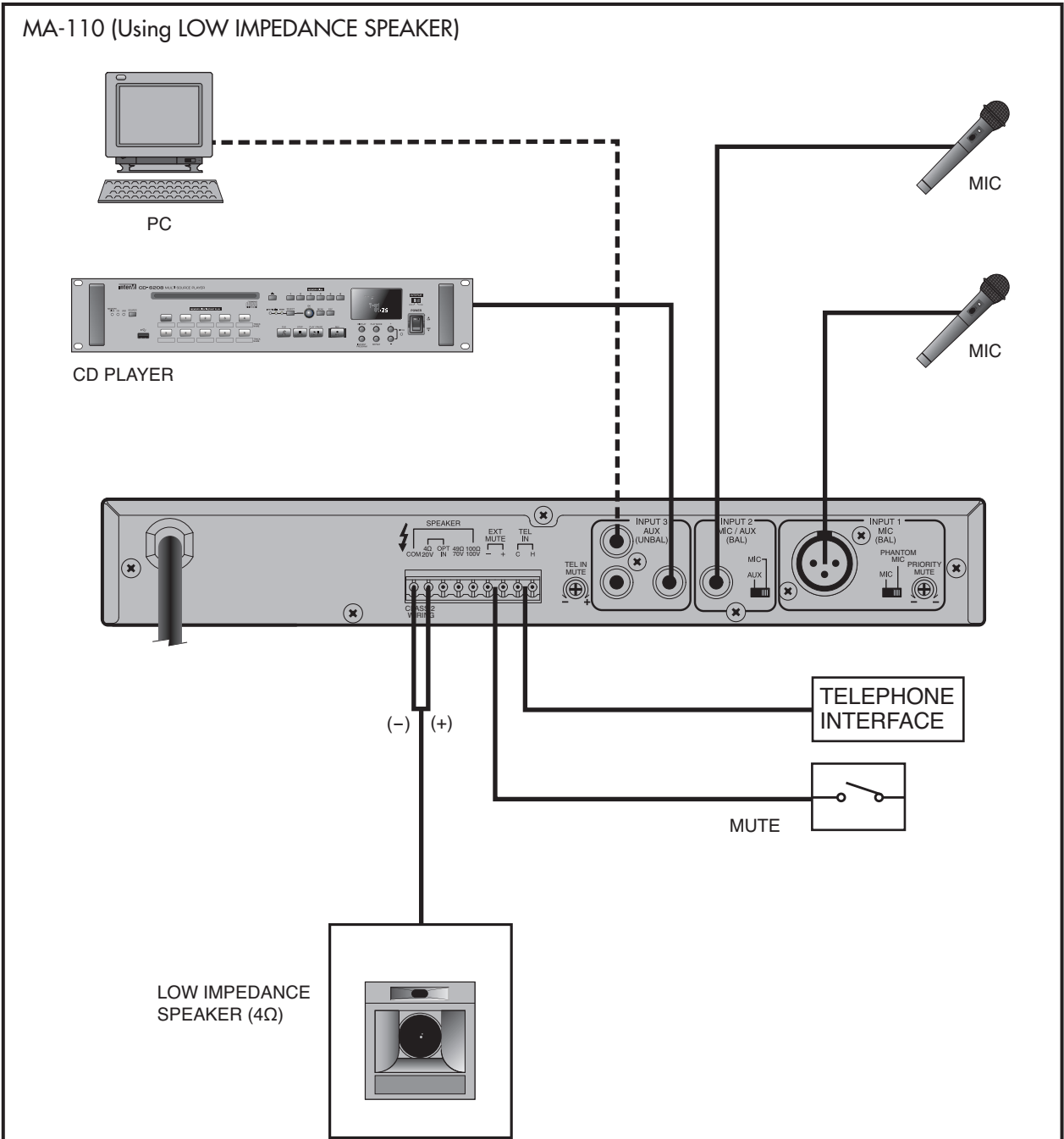

※ You have to select one between 4Ω and High voltage output.
 You never use both 4Ω with High voltage output at the same time.
 Please use only one output terminal. (4Ω, 70V, 100V)
 If you do this system will have damaged or work protection.

MA-110 (Using HIGH IMPEDANCE SPEAKER)

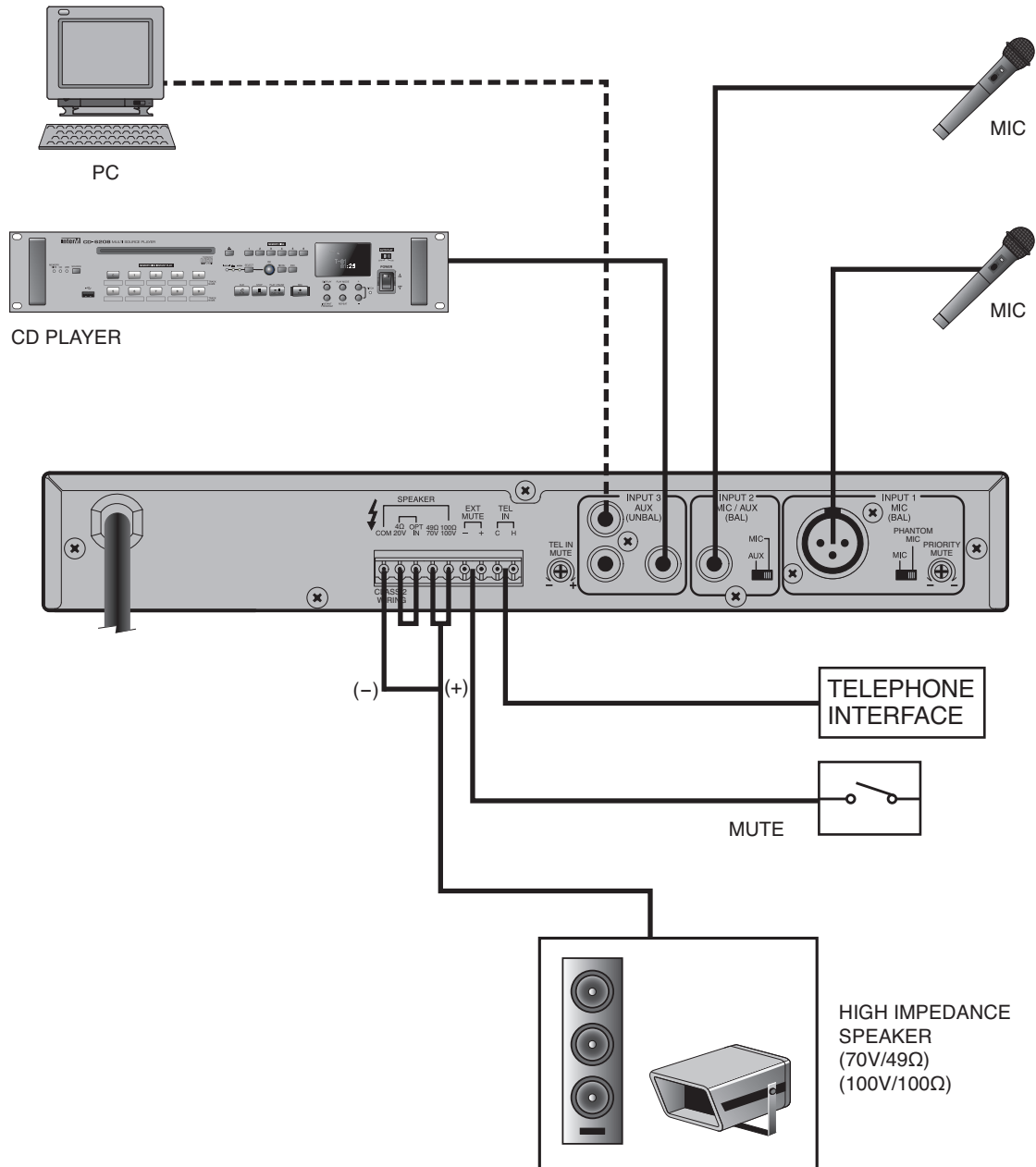

※ You have to select one between 4Ω and High voltage output.
 You never use both 4Ω with High voltage output at the same time.
 Please use only one output terminal. (4Ω, 70V, 100V)
 If you do this system will have damaged or work protection.

MA-110N (Using LOW IMPEDANCE SPEAKER)

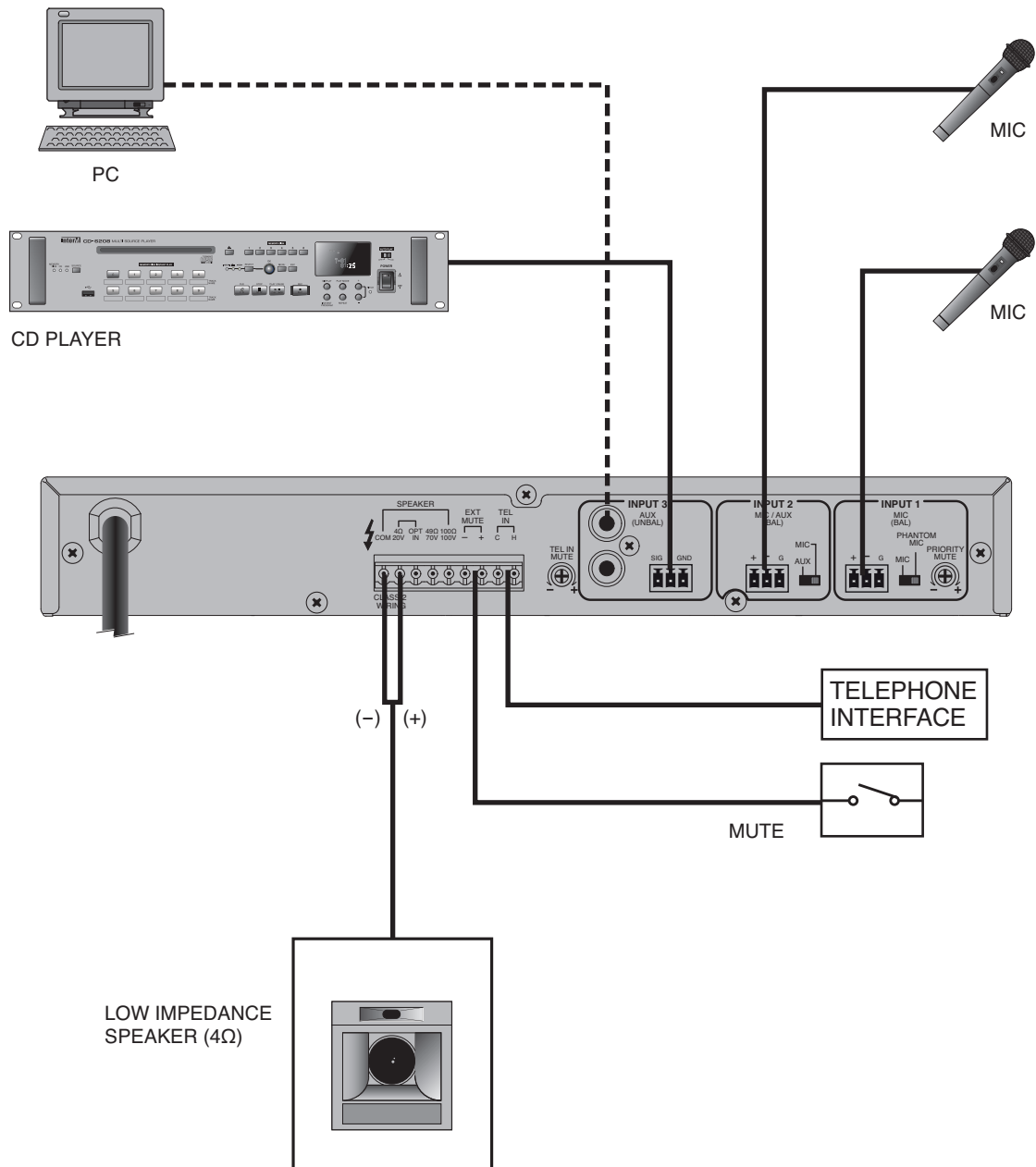

※ You have to select one between 4Ω and High voltage output.
 You never use both 4Ω with High voltage output at the same time.
 Please use only one output terminal. (4Ω, 70V, 100V)
 If you do this system will have damaged or work protection.

MA-110N (Using HIGH IMPEDANCE SPEAKER)

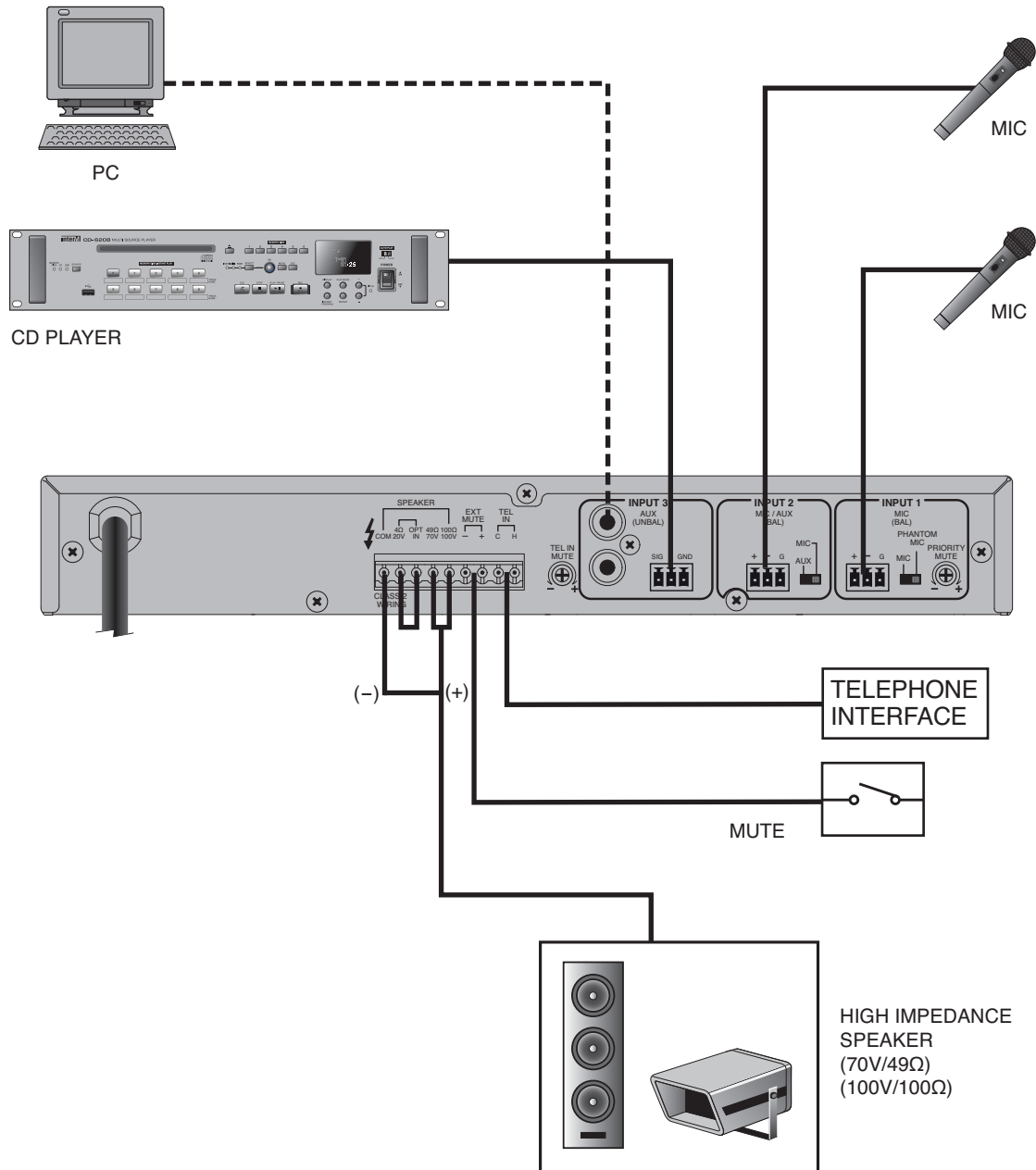

※ You have to select one between 4Ω and High voltage output.
 You never use both 4Ω with High voltage output at the same time.
 Please use only one output terminal. (4Ω, 70V, 100V)
 If you do this system will have damaged or work protection.

Block Diagram

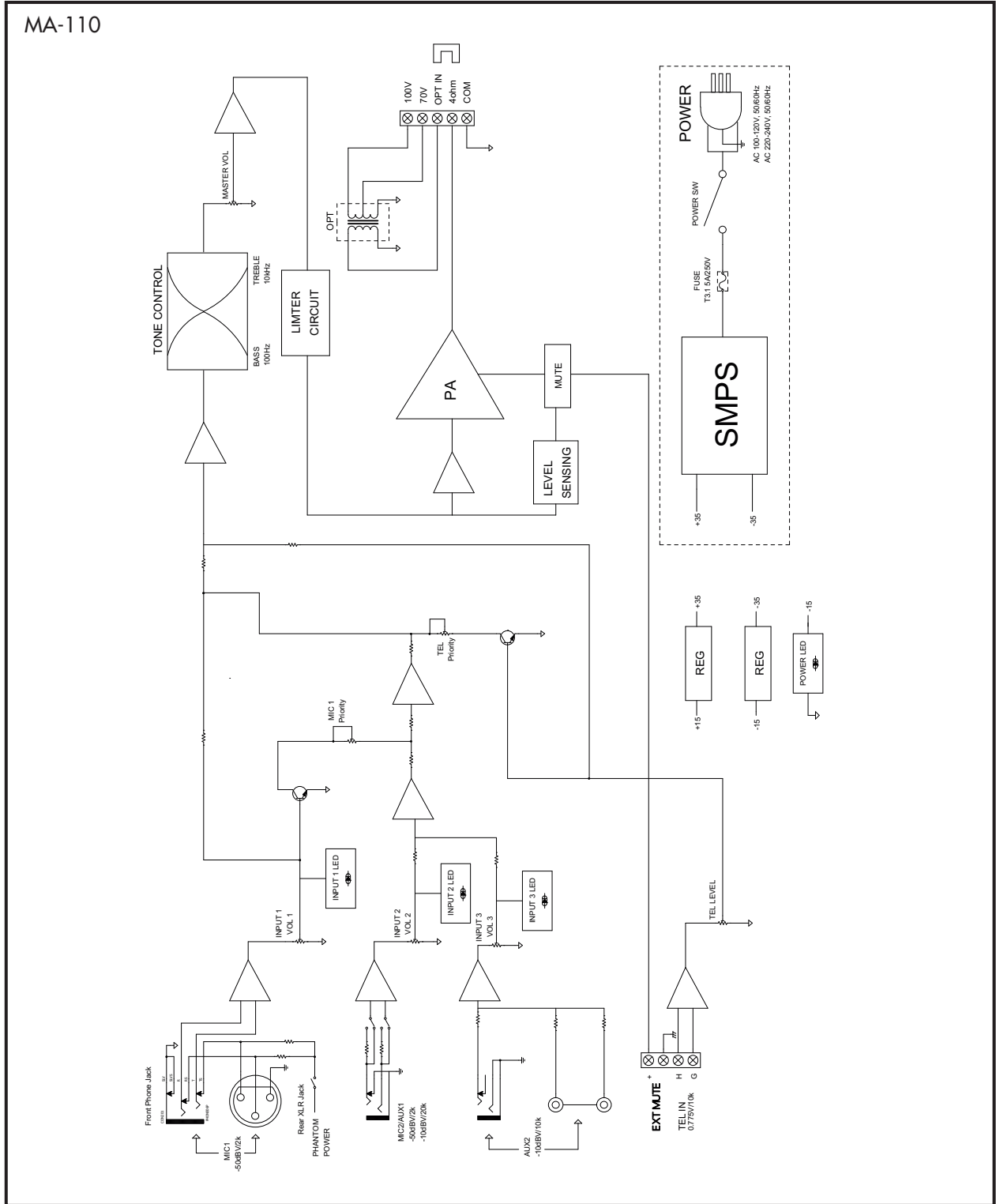

MA-110N

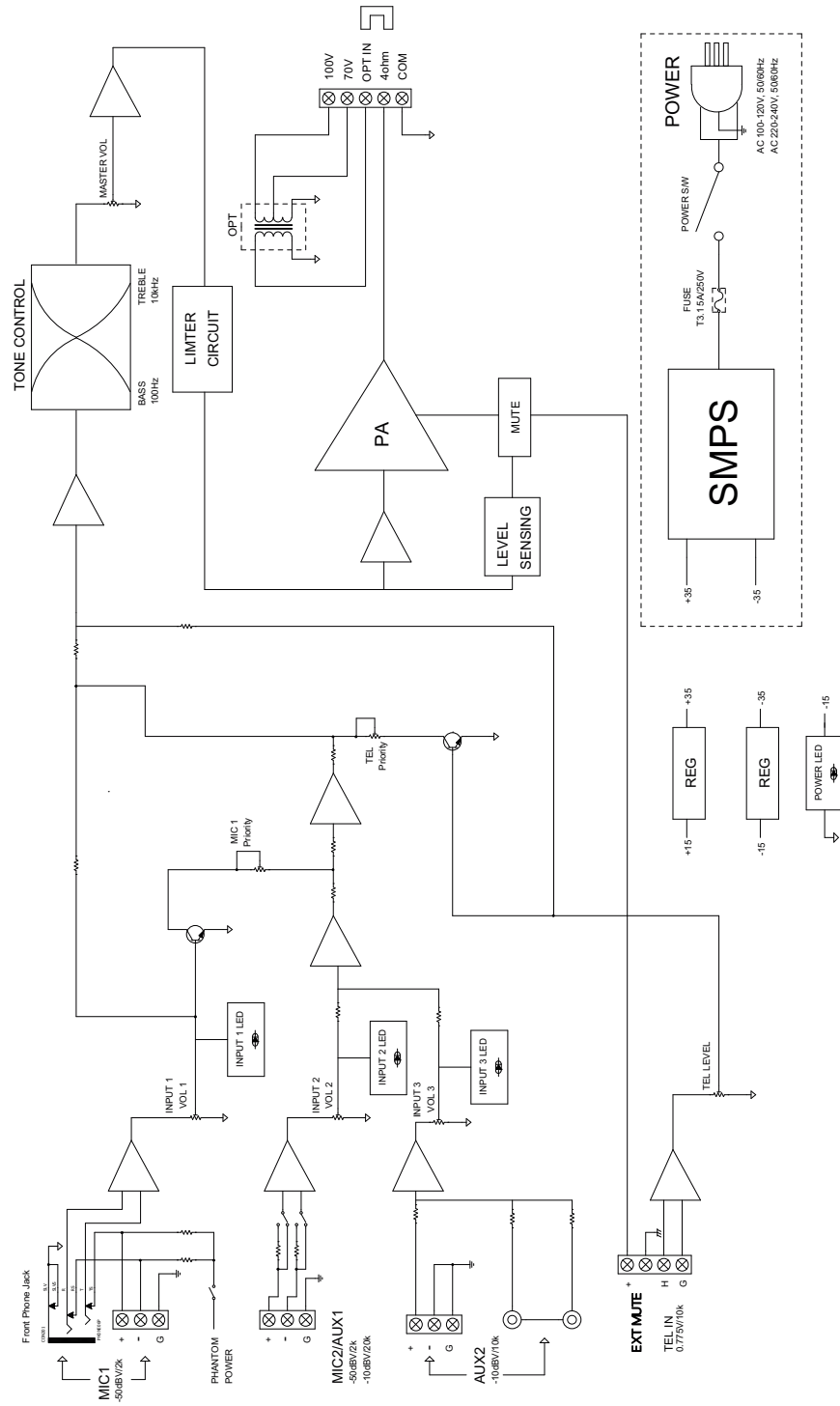

Specifications

* 0dBV = 1.0Vrms

		MA-110 / MA-110N
Rated Output Power		100W
Speaker Output Power / Impedance		20V/4Ω, 70V/49Ω, 100V/100Ω
Input Sensitivity / Impedance	INPUT 1	-50dBV / 2kΩ
	INPUT 2(MIC)	-50dBV / 2kΩ
	INPUT 2(LINE)	-10dBV / 20kΩ
	INPUT 3	-10dBV / 10kΩ
	TEL IN	0.775 / 10kΩ
Frequency Response (@ 1W, 4Ω)		80Hz ~ 18kHz
THD (@ 1kHz Rated Output)		Less than 1% at 100W(with AES-17 filter)
S/N	INPUT 1,2	Better than 60dB
	INPUT 3, TEL IN	Better than 70dB
Tone Control	BASS (100Hz)	±10dB
	TREBLE (10kHz)	±10dB
Operating Temperature		-10°C ~ +40°C
Power Source		AC 220–240V, 50/60Hz
Power Consumption		30W
Weight (Set)		3.05kg/6.7lb
Dimensions (Set)		300(W) x 44(H) x 230(D)mm/11.8(H) x 1.7(H) x 9.1(D)in

* Design and specification are subject to be changed for the improvement of product quality without pre notice.

- ※ **Remark:** 1. All specifications are measured with AES-17 filter.
 2. This system is used digital Amplifier (PWM Modulation) so the PWM leakage signal will appear to output terminal, but it doesn't matter. You can't hear the PWM leakage sound because of PWM frequencies is very higher than Audio frequencies.

※ DIMENSIONS

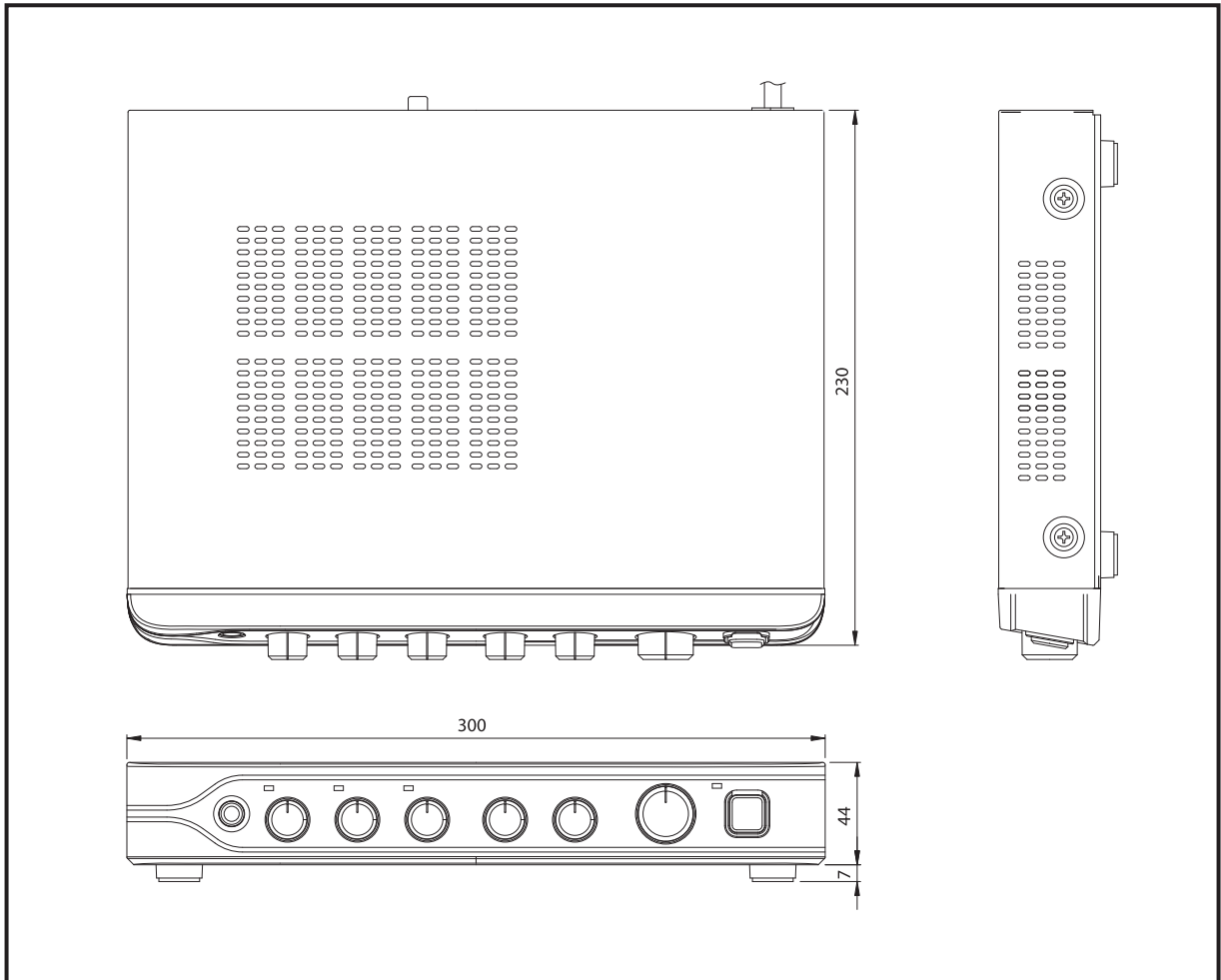

Service

Procedures

Take steps to insure the problem is not related to operator error or other products within the system. Information provided in the troubleshooting portion of this manual may help with this process. Once it is certain that the problem is related to the product contact your warranty provider as described in the warranty section of this manual.

Schematic

A Schematic is available by contacting your warranty provider.

Parts List

A Parts List is available by contacting your warranty provider.

Variations and Options

Variations

Products supplied through legitimate sources are compatible with local AC power requirements.

Options

No optional items are available for this product.

Warranty

Warranty terms and conditions vary by country and may not be the same for all products. Terms and conditions of warranty for a given product may be determined first by locating the appropriate country which the product was purchased in, then by locating the product type.

To obtain specific warranty information and available service locations contact Inter-M directly or the authorized Inter-M Distributor for your specific country or region.



Inter-M, Ltd. (Korea) began operations in 1983.

Since then, Inter-M has grown to become one of the largest manufacturers of professional audio and commercial sound electronics equipment in the world.

Inter-M has gained worldwide recognition for its own branded products, as well as private label manufacturing of electronics sold under other names (OEM).

The company is no longer just a Korean company, but rather a global company that is truly international in scope, with factories and offices in Korea and China, and sales and marketing operations located in Japan, Europe, and the U.S.A.

With more than 850 employees around the globe, Inter-M is well-poised for further growth and expansion.

Inter-M Corporation

SEOUL OFFICE : 719, DOBONG-RO, DOBONG-GU, SEOUL, KOREA

TEL : +82-2-2289-8140~8, FAX : +82-2-2289-8149

Home Page : <http://www.inter-m.com>, E-mail : overseas@inter-m.com

MADE IN KOREA
September 2023 154994