

# Cloud 46-80 4-Zone Mixing Amplifier

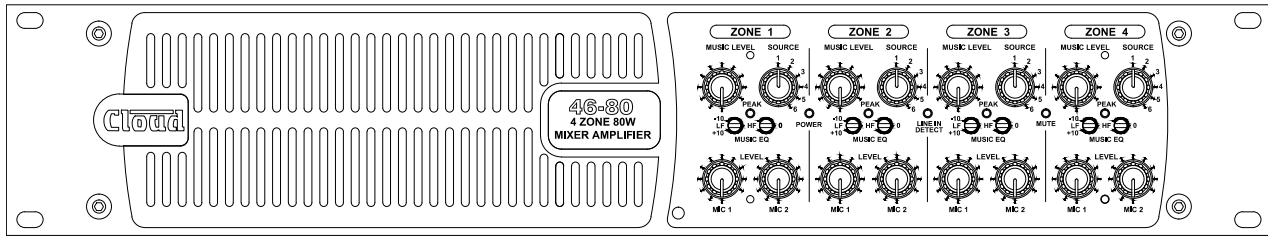

46-80 Front Panel

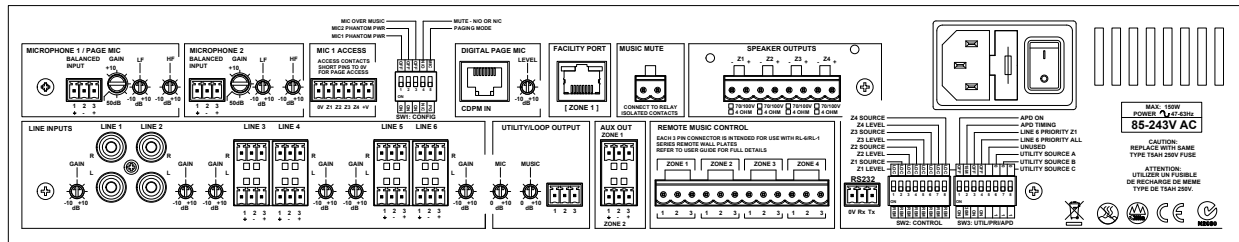

46-80 Rear Panel

## General Description

The Cloud 46-80 is a versatile, four-zone, rack-mounting (2U) audio mixing amplifier. It combines simple control of background music, microphone paging and power amplification for up to four zones in a single unit. It has extensive remote control facilities and is ideal for installation in premises such as pubs, bars, hotels, clubs, leisure and fitness centres, retail and other commercial premises, etc.

The 46-80 has four mono zone outputs, each driven by an 80 W (nominal rating) power amplifier stage: if less than four separate zones are required, the power stages may be paralleled by moving internal jumpers to permit dual stereo, quad mono or stereo + dual mono operation, with accordingly increased output power. The power stages have extensive protection circuitry to safeguard both the amplifier and loudspeakers.

Two versions are available, which differ only in their output circuitry: Model 46-80 is for use with low-impedance loudspeaker systems, while Model 46-80T is factory-fitted with four internal CXL-80T line transformers, and is thus suitable for driving 70/100 V-line loudspeaker systems. It is possible to retrofit CXL-80Ts to a Model 46-80; any or all of the outputs may be so configured. Switchable 65 Hz high-pass filters to prevent transformer core saturation at low frequencies are available for each Zone; these are set via internal jumpers and are factory-set to ON in the 46-80T.

The 46-80 has six stereo line inputs (four balanced and two unbalanced) and two microphone inputs; Mic 1 input can be configured for paging purposes. Both mic inputs feature individually selectable 15 V phantom power. Each line and mic input has its own preset type gain control on the rear panel, and each mic input additionally has HF/LF EQ adjustment to optimise the inputs for greatest clarity.

The front panel provides separate rotary user controls for music source selection, music level and level of each mic input for each zone. Preset controls for HF and LF EQ adjustment of each zone output are also fitted. A steel security cover is available to prevent access to the EQ controls. Each Zone has a Peak LED to warn of excessive signal level; further LEDs indicate power status, Music Mute active and Line Input "signal present". The Power LED is bi-colour and also indicates various fault states.

The 46-80 is equipped with a Cloud CDPM digital paging mic port, making it directly compatible with Cloud PM Series paging microphones. Alternatively, the Mic 1 input can be configured to suit most OEM paging systems. Zone selection for paging is via short-to-ground access connections, and the unit may be configured by internal jumper for automatic music ducking (mic-over-music priority), triggered by VOX control. Line Input 6 may be set, via rear panel DIP switches, to have priority over any other selected music source, either in Zone 1 or in all Zones. This facilitates connection of a jukebox, digital sound store or similar device. An input at the Facility Port from a remote input plate may be configured to duck when a Mic Input 1 signal is present; this allows emergency announcements to still be made in Zones that are using locally-connected input sources. All priorities give a smooth release when returning to the original music source.

In addition to the main Zone outputs, the 46-80 also has a Utility/Loop output, which carries its own mix of mic (summed post Zone 1's mic level controls) and music signals, set with rear panel controls. This is ideal for driving a hearing loop amplifier. The music source for this output can be configured to follow the selection in any Zone, or to carry either Line Input 1 or Line Input 6 at all times. There are two further outputs, taken from pre the power stage outputs of Zones 1 and 2: these are balanced at line level (0 dBu) and may be used to connect additional, external power amplifiers or for any other purpose.

A particularly useful feature of the 46-80 is the Zone 1 Facility Port; this allows a Cloud LM-2 active Line/Mic/Remote mixer module to be connected so that mic and/or line sources - such as radio mics, DJ mixers, MP3 players, laptops/tablets or other audio sources - may be plugged in within the zone itself. This simplifies the use of an area of the premises for presentations or other special functions where portable audio sources are in use. The Cloud BT-1 Bluetooth module and the L-1 and M-1 active remote line and mic input plates are also compatible with the Facility port. This port can also provide an additional balanced line input to Zone 1.

As with all Cloud commercial audio products, a remote Music Mute facility is provided, which may be used to satisfy the requirements of the Local Fire Officer.

All Cloud products are exclusively designed in the UK.

Every Cloud product is exhaustively tested for electronic performance and sonic perfection in Sheffield, England.

## General Description (*continued*)

Music level only, or music level and source selection may be controlled remotely in any or all zones, using standard Cloud RL or RSL Series remote control plates. Rear panel DIP switches allow remote control priority in each Zone to be set. The 46-80 may also be remotely controlled via RS-232 serial commands, making it easy to integrate with third-party AV control systems. The serial protocol offers both global and per-zone functions: examples are global muting of MIC 2, Music Mute and unit power down, while per-zone functions include control of MIC 1 muting, music level, and music source selection.

The 46-80 includes Automatic Power Down (APD) circuitry which puts the unit into an energy-efficient, low-power "sleep mode" if no input signals have been detected for a pre-determined time – either 15 or 30 minutes. The amplifier "wakes up" and can deliver full power in less than 1.5 s on re-application of any input signal. APD timing and enable/disable are set with rear panel DIP switches.

The 46-80 is strongly constructed in a 2U steel chassis: it has 19" rackmount ears as standard. It will run from any mains supply of between 85 and 243 VAC, 47 to 63 Hz; a fused IEC input socket with integral mains switch is fitted to the rear panel.

## Key features

- Eight input (6 x line, 2 x mic) mixing amplifier for four zones
- Provides flexible music, paging and announcement facilities in each zone
- 4 x 80 W power output
- 70/100 V-line version also available (46-80T)
- CXL-80T 70/100 V-line transformers may be retrofitted per-channel to 46-80
- Slave mode: power amplifier stages may be paralleled in various configurations and fed from a single programme source
- Peak limiter to protect power amplifier stages and loudspeakers
- Utility/Loop output with independent mic/music mix and user-definable music source
- Balanced, line level aux outputs (pre-power stage) from Zones 1 and 2, for connection of additional external amplifiers, etc.
- Front panel user controls for music source, music level and level of each microphone, for each zone
- Front panel preset controls for HF/LF EQ for each zone output: optional anti-tamper cover available
- Front panel indicators for amplifier power status, signal presence detection, Music Mute status and per-Zone signal peak
- Four balanced and two unbalanced stereo line inputs with individual gain trim controls
- Two balanced mic inputs; 15 V phantom power selectable on either or both
- CDPM port: compatible with Cloud PM Series digital paging mics
- Contact closure access port for paging zone selection
- Selectable VOX-triggered mic-over-music priority
- Gain and HF/LF EQ adjustment for mic input (rear panel)
- Selectable LINE 6 priority in Zone 1 or all Zones
- Zone 1 Facility Port for connection of optional remote input plates: LM-2 mic/line input + music controls, BT-1 Bluetooth input, L-1 line input, M-1 mic input
- Facility Port may also be used as additional balanced line input to Zone 1
- 65 Hz high-pass filter selectable per-Zone (for use with 70/100 V-line systems)
- Music Mute control input (N/O or N/C) for interface to emergency system
- Compatible with standard Cloud remote control panels: RL Series (music level) and RSL Series (music level and source selection), per-zone
- RS-232 port for serial control of per-Zone MIC 1 muting, music level and source plus global unit standby, Music Mute and MIC 2 muting
- User-selectable Automatic Power Down for maximum energy efficiency
- 2U 19" rack-mounting unit
- Convection-cooled (no fan): silent in operation

## Block Diagram

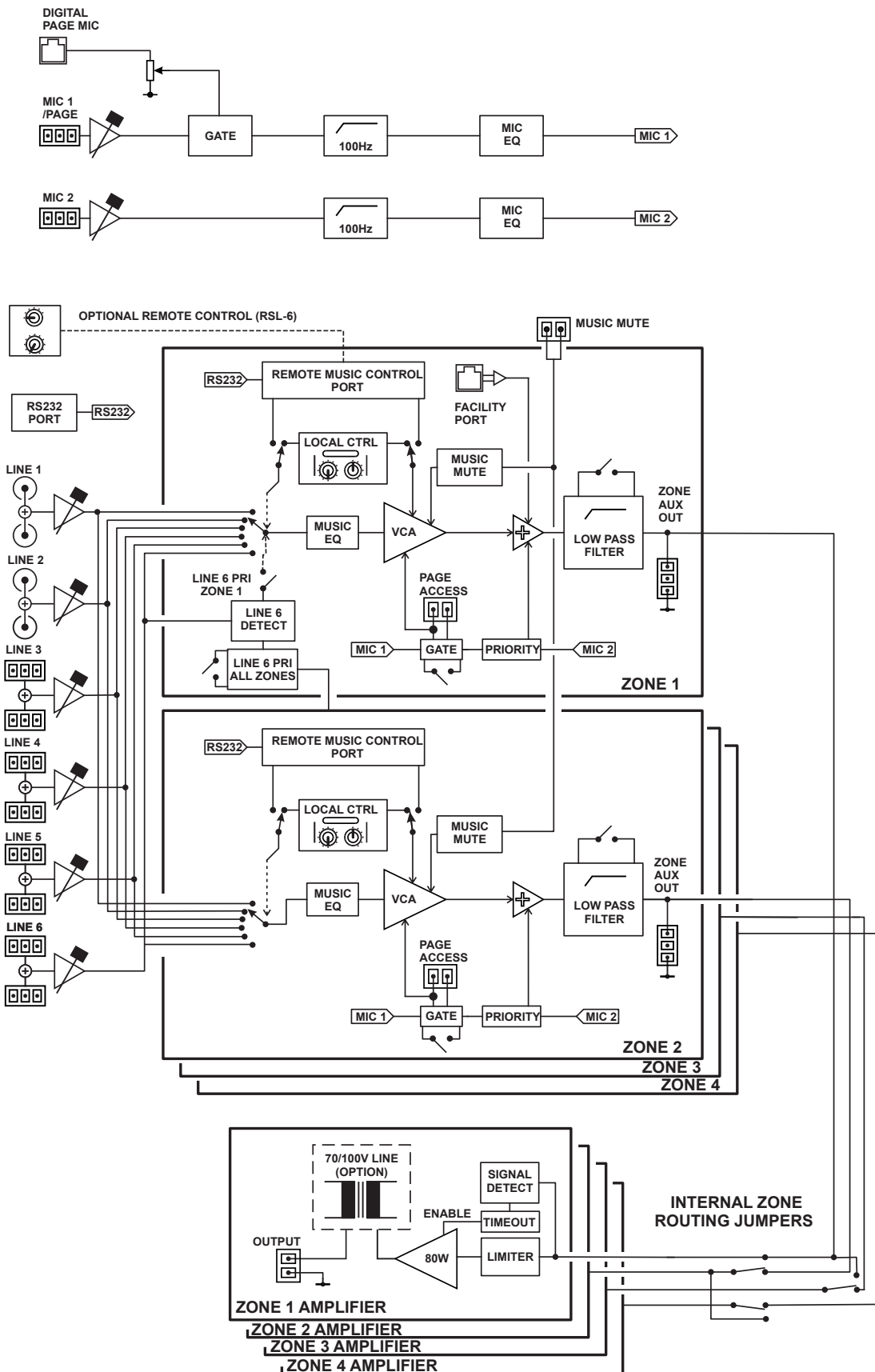

## Channel configurations

The internal routing jumpers permit various permutations of mono, stereo and multi-channel operation without any external parallel wiring. Some possibilities are shown below:

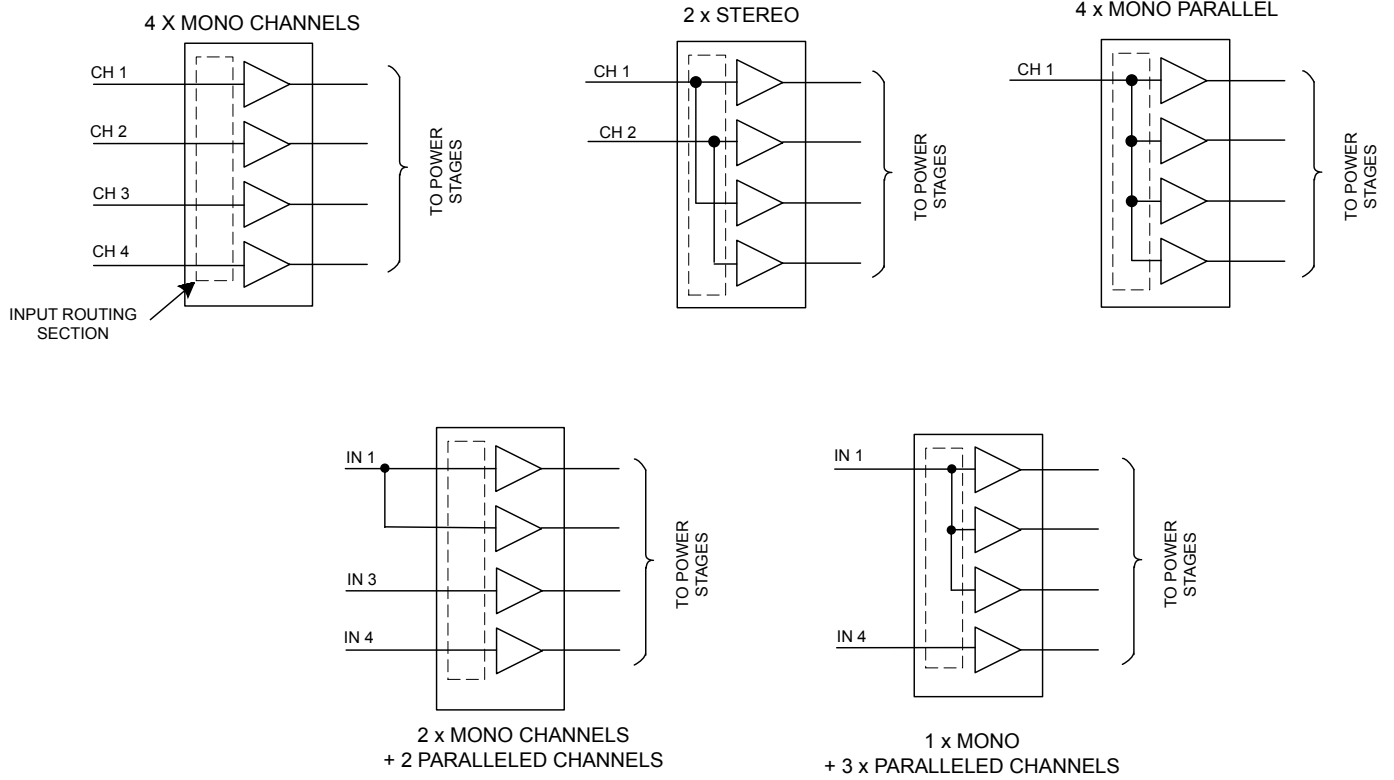

## System Example

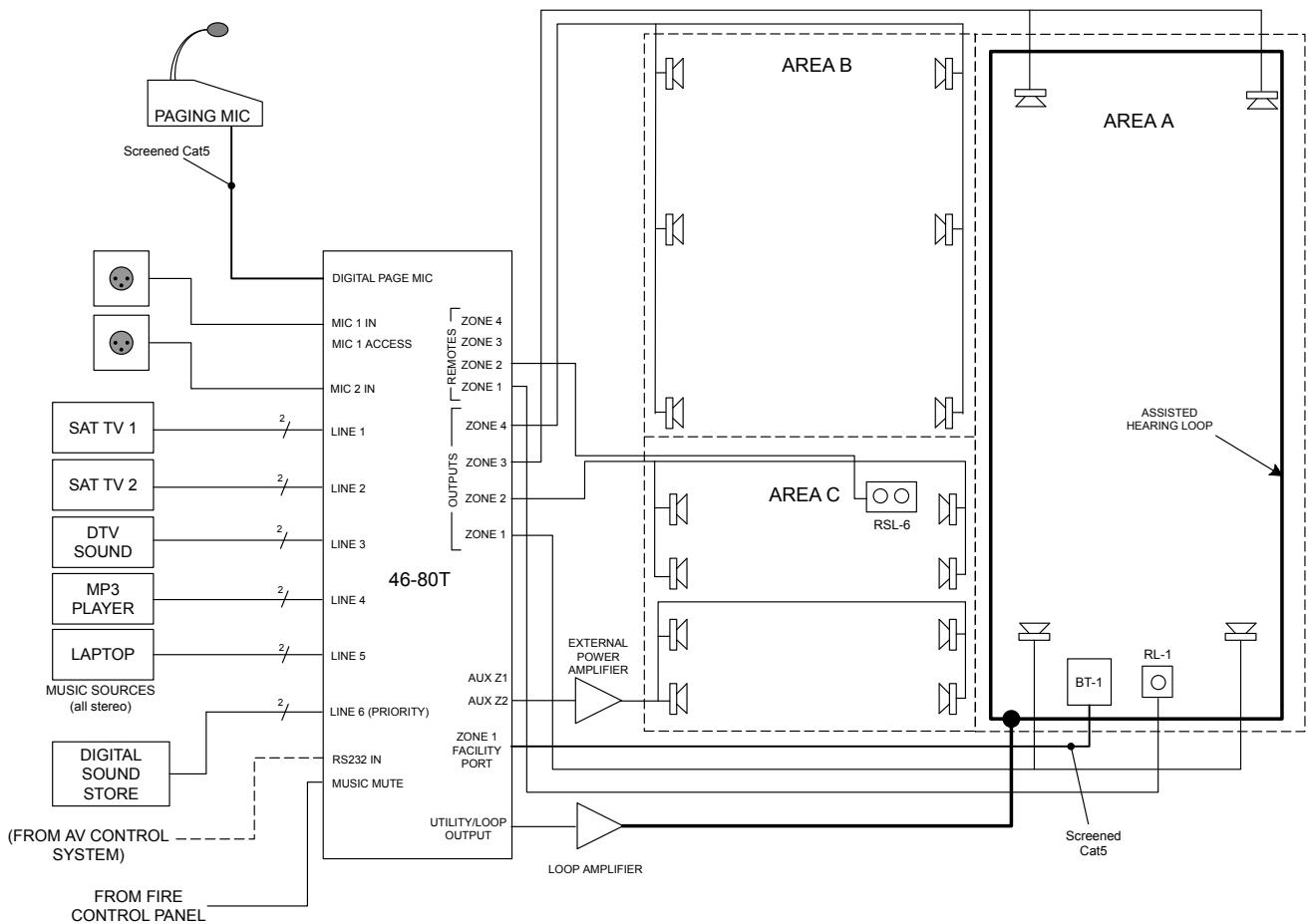

The example shows how the various features of a 46-80T might be used in a gastropub or similar installation, based on three separate areas.

- The example assumes Zones 1 and 3 power stages are paralleled internally to double the power available for Area A; this means that Zone 1's control section will drive the power amplifier stages for both Zone 1 and Zone 3. All the loudspeakers are physically in Area A.
- The speakers in Area B are driven by Zone Output 4 and those in Area C by Zone Output 2.
- Area C might need additional amplification, so as well as some of the loudspeakers being driven directly by Zone 2's output (using series/parallel wiring to ensure that the total load impedance remains above 4 ohms), Zone 2's Aux output is used to drive a separate external power amplifier, which in turn drives further loudspeakers.
- Five stereo music sources are connected to the line inputs. Note that a digital sound store is connected to Line 6; if the Line 6 priority option is enabled for all Zones, a pre-recorded announcement (e.g., in an emergency) will be audible throughout the building, overriding the local selection in each Zone for the duration of the message.
- A Cloud Digital Paging Microphone is connected to the CDPM port with a single screened Cat 5 cable; the 46-80T allows paging to any or all of the areas.
- A BT-1 remote Bluetooth input plate is shown in Area A; this would be wired back to the 46-80T's Zone 1 Facility Port. This would allow audio to be streamed wirelessly from a Bluetooth-enabled laptop, tablet or other device located within the area itself, and routed to the loudspeakers in Area A.
- The two mic inputs are wired to XLR sockets (suitable decorative plates are available as standard Cloud accessories) to allow the connection of a microphone which can be routed to any or all areas at various levels.
- The system also shows a Cloud RL-1 remote control plate installed in Area A to allow local volume control, and an RSL-6 in Area C to allow local source selection as well as volume control. Note that the RL-1 in Area A is connected to Zone 1's remote control port; this is because the Zone 1/Zone 3 slave mode uses Zone 1's pre-amplifier channel to derive the audio feed. The RSL-6 in Area C is connected to Zone 2's remote control port as Zone 2 output is feeding this area.

## Technical Specifications

Line Inputs 1 & 2 (unbalanced)		
Frequency Response	±0.5 dB, 20 Hz to 20 kHz	
THD + N	<0.02%, 1 kHz sine wave	
Sensitivity	195 mV (-12 dBu) to 2.0 V (+8 dBu)	
Gain control range	-10 dB to +10 dB	
Input Impedance	10.2 kohms	
Headroom	17 dB	
Noise	<-88.5 dB (nominal gain, max level, 22 Hz to 22 kHz)	
Line Inputs 3 to 6 (balanced)		
Frequency Response	-0.5 dB @ 20 Hz; -0.5 dB @ 20 kHz	
THD + N	<0.015%, 1 kHz sine wave	
Sensitivity	195 mV (-12 dBu) to 2.0 V (+8 dBu)	
Gain control range	-9 dB to +11 dB	
Input Impedance	10.2 kohms	
Headroom	17 dB	
Noise	<-88.5 dB (nominal gain, max level, 22 Hz to 22 kHz)	
Microphone Inputs		
Frequency Response	-6 dB @ 100 Hz (fixed filter) to ±1 dB @ 20 kHz	
THD + N	<0.05%, 1 kHz sine wave	
Gain Range	10 dB to 48 dB	
Common mode rejection	<58 dB @ 1 kHz	
Input Impedance	3.3 kohms (balanced)	
Headroom	18 dB	
Noise (EIN)	-127.2 dB; 22 Hz to 22 kHz, maximum gain, Rs = 150 ohms	
Phantom Power	15 V, individually selectable	
Equalisation	HF: ±10 dB @ 5 kHz; LF: ±10 dB @ 100 Hz	
Main Outputs		
Low Impedance Outputs (Model 46-80)	80 W into 4 ohms	
High Impedance	100 V operation	80 W constant voltage into 125 ohm minimum load
Outputs (Model 46-80T)	70 V operation	70.7 W constant voltage into 62.5 ohm minimum load
Amplifier protection	Fixed level signal limiter, protection against DC, over current, over temperature	
Cooling	Natural convection	
Utility/loop Output		
Frequency Response	±0.5 dB, 20 Hz to 20 kHz	
THD + N	<0.01% @ 1 kHz	
Nominal level	0 dBu (0.775 Vrms)	
Aux Outputs (Zones 1 & 2)		
Frequency Response	±0.5 dB, 20 Hz to 20 kHz	
THD + N	<0.05% @ 1 kHz	
Nominal level	0 dBu balanced (0.775 Vrms)	

## Technical Specifications (continued)

General		
Power Input	85 to 243 VAC, 47 to 63 Hz	
Normal operating temperature	0 °C to 35 °C (Note: performance and specifications cannot be guaranteed outside of this range)	
Power consumption	Standby <sup>1</sup>	8.6 W, 27.5 VA
	Idle <sup>2</sup>	20.3 W, 38.6 VA
	1/8th Power (4 ohms) <sup>3</sup>	Lo-Z output (4 ohms): 64.9 W, 85.2 VA
		Hi-Z output (100 V into 125 ohms): 92 W, 109.7 VA
1/3rd Power (4 ohms) <sup>4</sup>	Lo-Z output (4 ohms): 126 W, 154 VA	
	Hi-Z output (100 V into 125 ohms): 176 W, 198 VA	
Heat Loss	Standby <sup>1</sup>	30.8 kJ/hr (29 BTU/hr)
	Idle <sup>2</sup>	72 kJ/hr (69 BTU/hr)
	1/8th Power (4 ohms) <sup>3</sup>	Lo-Z output (4 ohms): 103 kJ/hr (98 BTU/hr)
		Hi-Z output (100 V into 125 ohms): 187 kJ/hr (177 BTU/hr)
1/3rd Power (4 ohms) <sup>4</sup>	Lo-Z output (4 ohms): 129 kJ/hr (122 BTU/hr)	
	Hi-Z output (100 V into 125 ohms): 287 kJ/hr (272 BTU/hr)	
Dimensions (w x h x d)	Net	482.6 mm x 88 mm (2U) x 320 mm, 19" x 3.5" x 12.6"
	Shipping (Gross)	610 mm x 200 mm x 460 mm, 24" x 8" x 18"
Weight	Net	46-80: 5.5 kg / 12.3 lbs
		46-80T: 8.6 kg / 19.3 lbs
	Shipping (Gross)	46-80: 8 kg / 17.9 lbs
		46-80T: 11.1 kg / 24.9 lbs

Notes re Power Consumption and Heat Loss measurements:

All measurements at 230 VAC 50 Hz power input

1. Standby: amplifier in standby state (STATUS LED steady red)
2. Idle: amplifier not in standby state (STATUS LED steady green), but no audio output
3. 1/8<sup>th</sup>. Power: constant sound level at 10 W output (audio mainly clean, only occasional clipping)
4. 1/3<sup>rd</sup>. Power: constant sound level at 27 W output (audio beginning to become compressed, limited or heavily clipped)

## Performance Graphs

46-80 Line Input Frequency Response

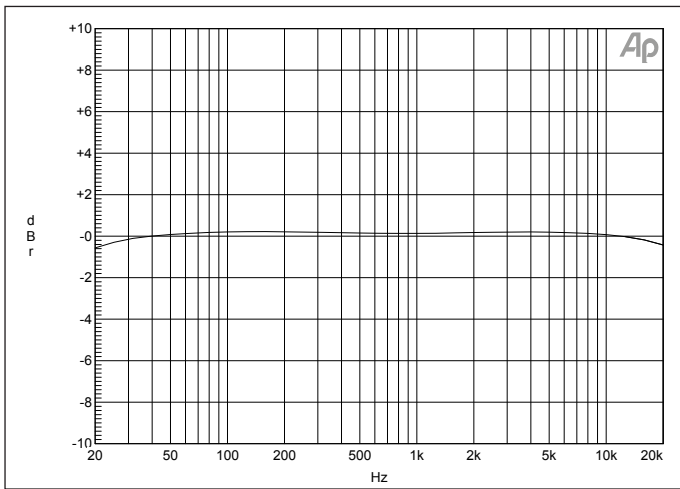

46-80 Mic Frequency Response & Tone Control Response

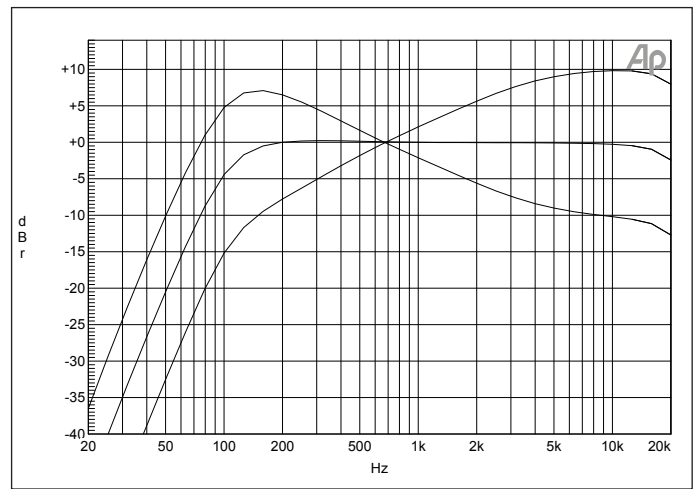

46-80 Line Input Tone Controls

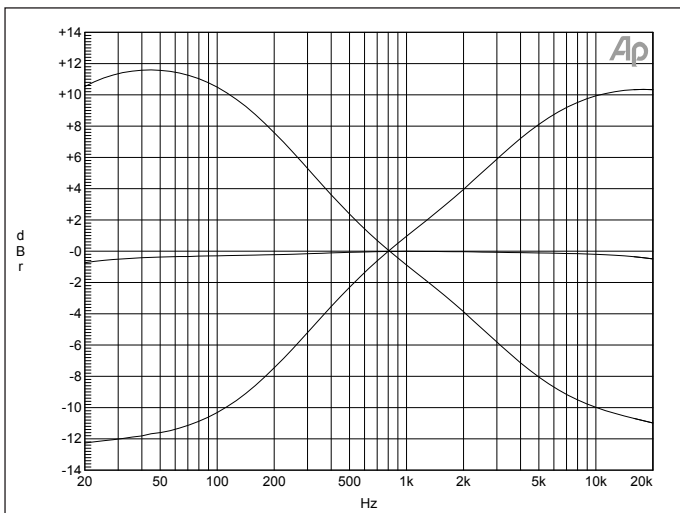

46-80 THD+N vs Output Power

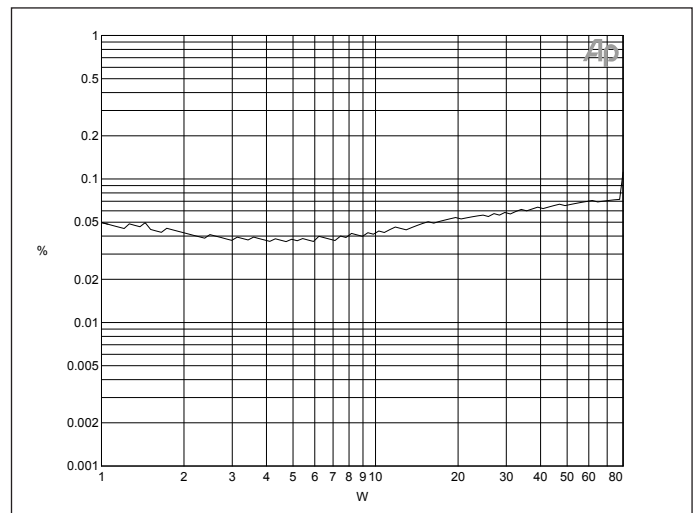



## Architect's and Engineer's Specification

The mixing amplifier shall have four mono output channels for driving separate zones; each channel shall be capable of driving 80 watts into a 4 ohm load. Optional transformers shall be available to allow any or all channels of the mixing amplifier to drive 70 V or 100 V-line loudspeaker distribution systems; the transformers shall be fitted within the chassis. A version of the mixing amplifier shall also be available with four transformers pre-installed. Each channel shall have a selectable high-pass filter to minimise the effect of transformer core saturation by low frequencies when the mixing amplifier is used with 100/70 V-line systems.

It shall be possible to configure the four output channels in various ways: alternative configurations shall include two pairs, one pair plus two independent zones, one zone plus three zones in parallel and all zones in parallel as a minimum: zone outputs so configured will be controlled by a single set of controls and process the same programme selection. Two of the output channels shall be equipped with balanced line level outputs suitable for driving external amplifiers; use of these outputs shall not interrupt the unit's normal operation.

The mixing amplifier shall be equipped with two unbalanced stereo music inputs on rear panel phono sockets (RCA jacks), four electronically balanced stereo music inputs on rear panel multi-pin screw-terminal connectors and two electronically balanced microphone inputs on multi-pin screw-terminal connectors. Each music input shall have an input gain trim control with a range of 20 dB; these controls shall not be user-accessible. Phantom power shall be independently selectable at each microphone input; selection of phantom power shall not require removal of the unit's lid. A gain control of the preset type shall be provided for each microphone input; these shall have a range of 40 dB. There shall be separate two-band equalisation adjustments of the preset type for each microphone input; none of these adjustments shall be accessible from the front panel. One microphone input shall be configured to operate with paging microphones. There shall also be provision for connection of suitably-equipped paging microphones via a single screened Cat 5 cable and RJ45 connector; this connector shall carry microphone signals, destination zone identification and DC power for the microphone unit.

A control input shall be provided to activate one microphone input by external contact closure, and route its signal to any or all outputs. It shall be possible to configure the mixing amplifier such that this microphone signal automatically reduces the music signal by approximately 30 dB while it is present. It shall also be possible to configure the mixing amplifier so that one line input will automatically override all others in one zone, even if unselected.

Each of the output channels shall have dedicated front panel controls for selection of music source, music level and the levels of each microphone input. The front panel shall also have controls of the preset type for two-band equalisation adjustment in each zone. An optional tamper-proof cover shall be available, which when fitted, makes the equalisation controls inaccessible in normal operation.

The mixing amplifier shall provide a further balanced line level output: it shall be possible to adjust a mix of music and microphone signals independently of any of the main output channels; the microphone signal at this output shall be derived from one zone only but it shall be possible to select the source of the music signal at this output to follow the music source set for any one zone, or to be permanently applied to either of two line inputs, one of which shall be that having selectable priority over the other line inputs.

Optional passive remote control plates shall be available to permit control of i) music level in any zone; ii) music source selection and music level in any zone; it shall be possible to connect these to the mixing amplifier at any time. The remote control panels shall connect via rear panel multi-pin connectors. It shall be possible to disable either the front panel music level or the music level and music source selection controls by settings which are not themselves accessible from the front panel.

An external control input shall be provided to allow muting of the music source by a fire alarm or other external emergency system via isolated, 'volt-free' contacts, and this input shall be configurable to respond to either a short or open external circuit.

One zone of the mixing amplifier shall be equipped with a multi-function control connector of the RJ45 type. A range of active remote input modules shall be available which may be wired to this connector, enabling external mic or line level signals to be routed to the zone from a remote location: the range shall include a module capable of wirelessly streaming stereo audio from compatible devices using the Bluetooth protocol. The connector shall also permit the connection of a balanced audio source and provide DC power for the remote modules. It shall be possible to configure the mixing amplifier so that a signal at the mixing amplifier's microphone inputs has priority over a signal at this connector.

The mixing amplifier design shall incorporate circuitry for protection of the power output stages and connected loudspeakers: the mixing amplifier shall cease to pass audio and disconnect the loudspeakers in the event of excessive internal temperature or detection of DC or excessive current at the outputs. The mixing amplifier shall automatically enter a quiescent mode if no input signals are received for either 15 or 30 minutes, this time being selectable, and in this state the power consumption shall not exceed 12 W; the unit shall return to its normal operating state on the re-application of an input signal in less than 1.5 seconds. Quiescent mode shall be visually indicated on the front panel.

The mixing amplifier shall be equipped with a control port able to transmit and receive serial data conforming to standard RS-232C protocols. The set of received commands shall include music level control, music source selection and muting of one microphone input in each zone; further commands shall activate/de-activate the emergency music mute control input, place the mixing amplifier into its quiescent mode and mute the alternative microphone input in all zones simultaneously. This command set shall be regarded as a minimum requirement.

The mixing amplifier shall be built in a 2U steel chassis for mounting in a standard 19" rack. It will be fitted with a rear panel power switch; operation shall be visually indicated on the front panel. It will be capable of operating from AC mains supplies in the range 85 to 243 V, 47 to 63 Hz. The AC supply shall be connected via a detachable IEC cable.

The mixing amplifier shall be the Cloud 46-80; the optional passive remote control plates shall be the Cloud RL-1 (music level only) and the Cloud RSL-6 (music level and source selection) and the optional active remote input modules shall be the Cloud LM-2 (line and microphone level inputs plus control of music source selection) and the Cloud BT-1 (Bluetooth compatible). The optional 70/100 V transformer shall be the Cloud CXL-80T.