

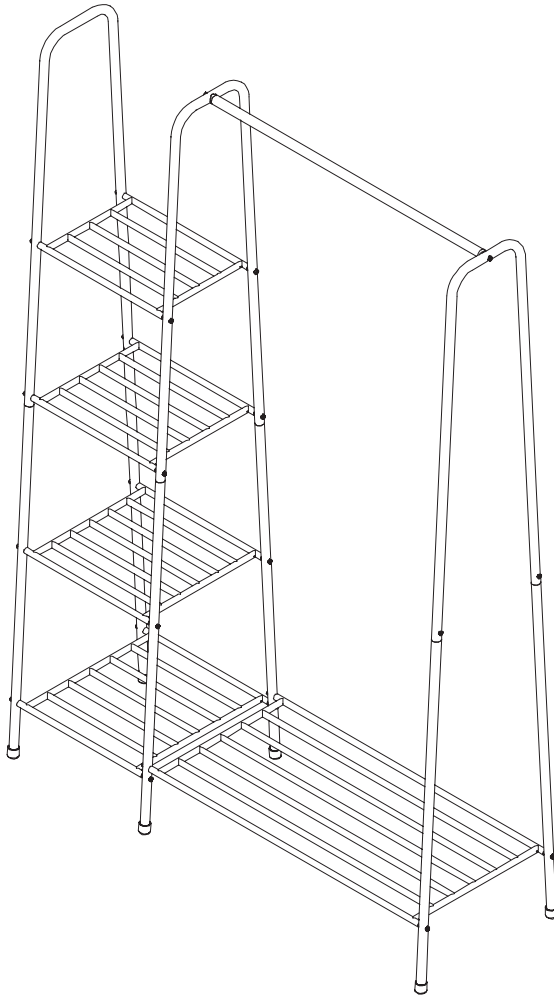





WRD-09058

countryside chic wardrobe



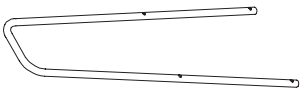
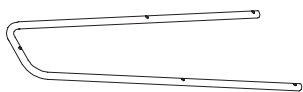
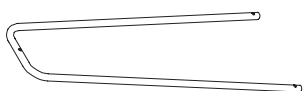

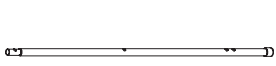

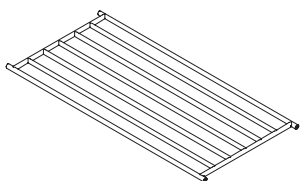
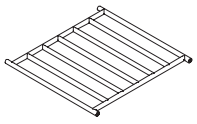
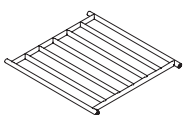
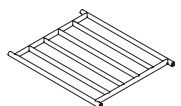
45 in L x 15 in W x 66 in H

PARTS LIST

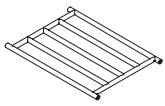
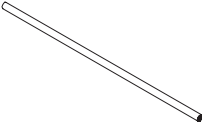
PART/ILLUSTRATION	(QTY)	DESCRIPTION
A 	(1)	top shelf supports
B 	(1)	top shelf supports
C 	(1)	top shelf supports
D 	(2)	bottom shelf supports
E 	(2)	bottom shelf supports
F 	(2)	bottom shelf supports
G 	(1)	shelf
H 	(1)	shelf
I 	(1)	shelf
J 	(1)	shelf

PARTS LIST

PART/ILLUSTRATION	(QTY)	DESCRIPTION
K 	(1)	shelf
L 	(1)	horizontal bar
M 	(22)	long screws
N 	(2)	short screws
O 	(2)	plastic caps
P 	(1)	hex wrench

ASSEMBLY

1

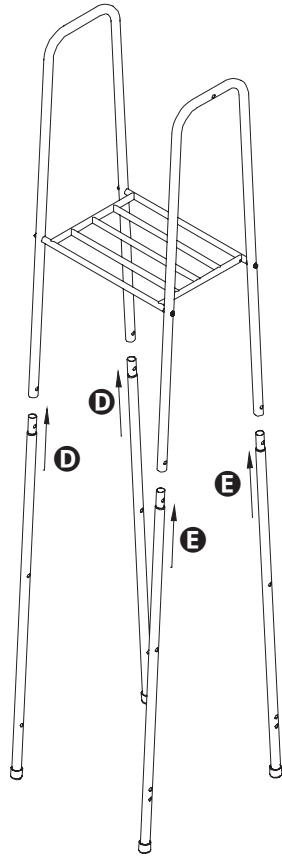
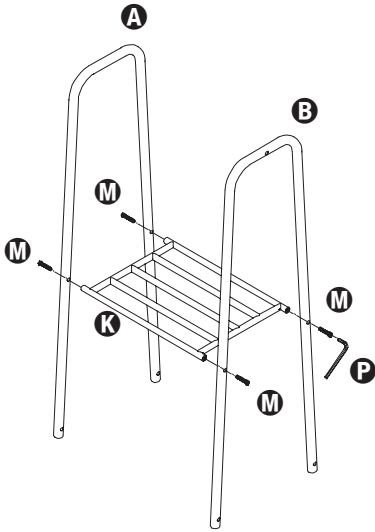

ASSEMBLY

3

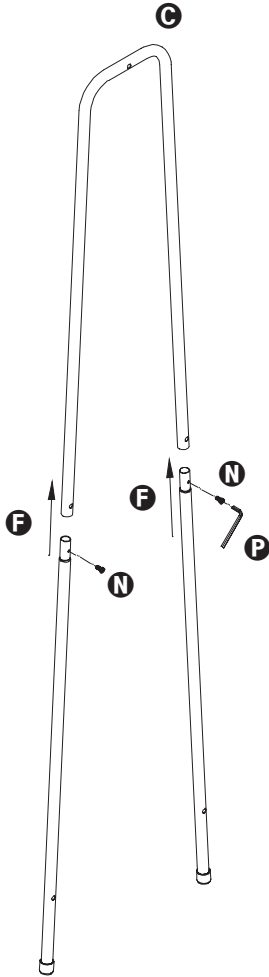

ASSEMBLY

4

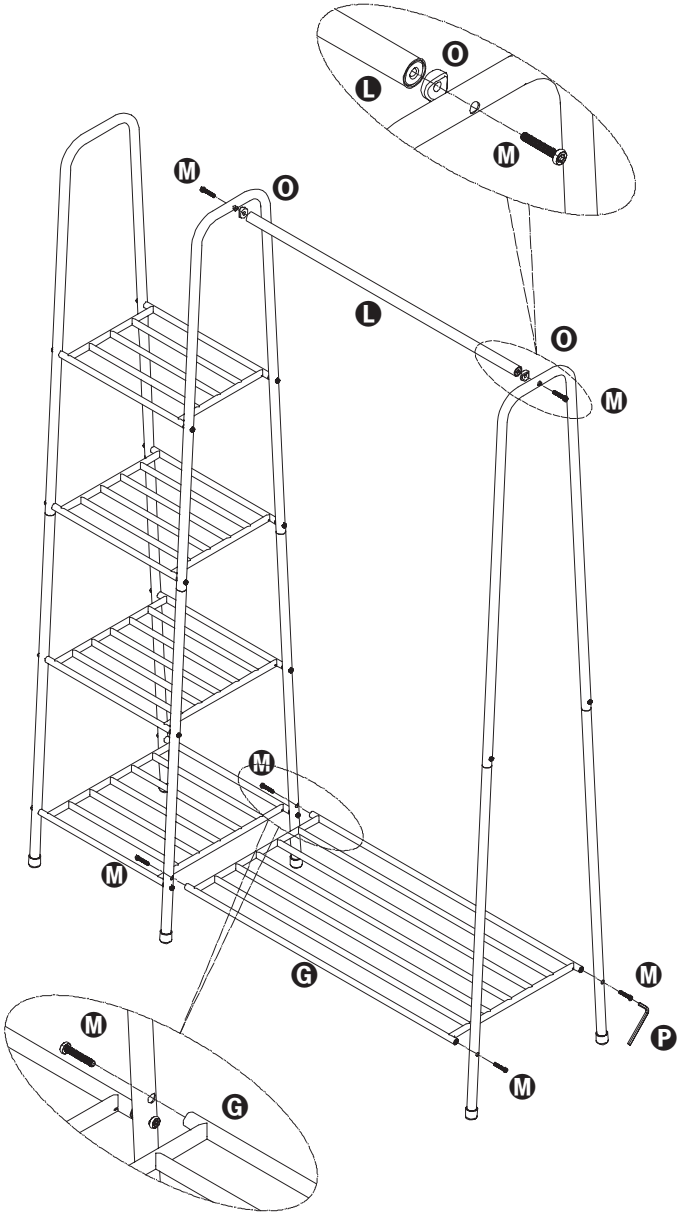



YOUR SOURCE FOR
ORGANIZATION,
STORAGE & STYLE

Honey-Can-Do International

5300 St. Charles Road, Berkeley, IL 60163 USA

877.242.2636 | honeycando.com | customerservice@honeycando.com

©2020 Honey-Can-Do International, LLC | All Rights Reserved

Visit [youtube.com/myhoneycando](https://www.youtube.com/myhoneycando) to watch our assembly videos.