

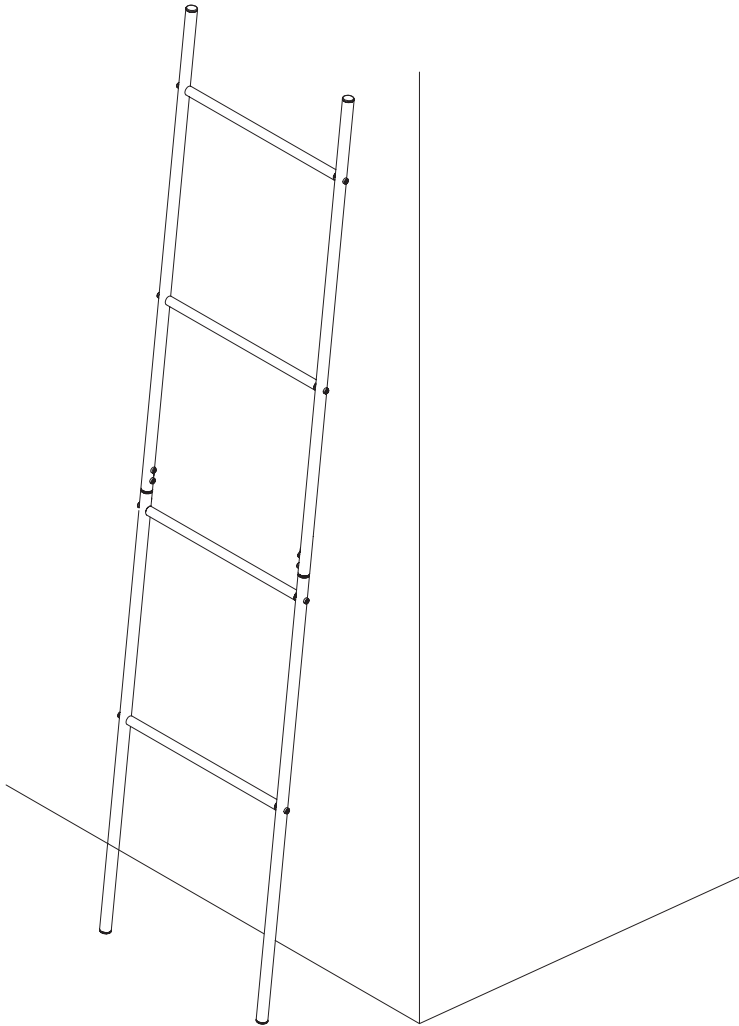



SHF-08576

ladder rack

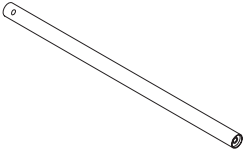
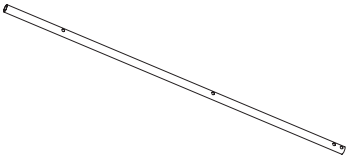
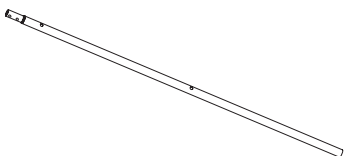

14.96" W x 69.09" H

PARTS LIST

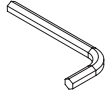
PART/ILLUSTRATION	(QTY)	DESCRIPTION
A 	(4)	horizontal ladder bars
B 	(2)	upper vertical bars
C 	(2)	lower vertical bars
D 	(8)	long hex screws
E 	(4)	short hex screws
F 	(1)	hex wrench

ASSEMBLY

1

do not tighten screws fully until the end

2

do not tighten screws fully until the end

2

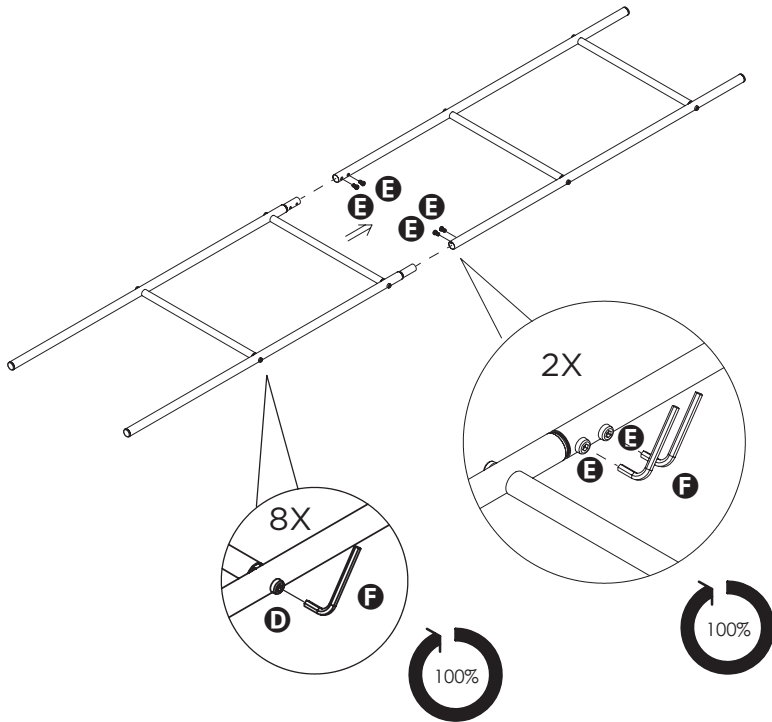

tighten all screws fully for stability

LIMITED LIFETIME WARRANTY

Honey-Can-Do International, LLC (HCD) warrants its products will be free from defects in materials and workmanship when used for normal personal or household use. Except as provided below HCD, at its option, may offer a comparable product or offer a replacement part or request that the item be returned to the place of purchase. This warranty DOES NOT apply to damage caused by negligence, misuse, excessive use, improper cleaning, improper assembly, or any circumstances not directly attributable to manufacturing defects. Proof of purchase is required in the form of a receipt (copy or original) to validate warranty. HCD provides this limited lifetime warranty in lieu of all other warranties, either express or implied. In no event shall HCD, its affiliates, or subsidiaries be responsible for consequential or incidental damages arising out of a claim of defective product. Some states or provinces do not allow some exclusions or limitations, so the above statement may not apply to you. This warranty gives you specific legal rights. Additional rights vary by state or province.

WARNING:

Keep bags and plastic sheeting away from babies and children. Do not use in cribs, beds, carriages or playpens. The plastic may cling to the nose and mouth and prevent breathing.



YOUR SOURCE FOR
ORGANIZATION,
STORAGE & STYLE

Honey-Can-Do International

5300 St. Charles Road, Berkeley, IL 60163 USA

877.242.2636 | www.honeycando.com

©2019 Honey-Can-Do International, LLC | All Rights Reserved

Visit www.youtube.com/myhoneycando to watch our assembly videos.