

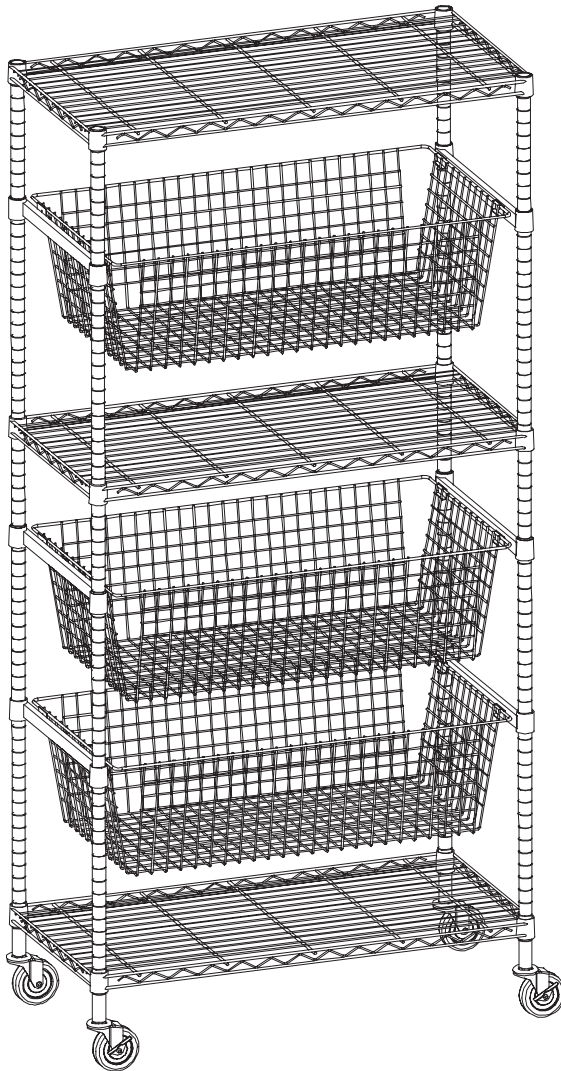

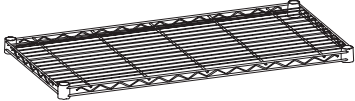

sports storage
almacenamiento deportivo
stockage de sport

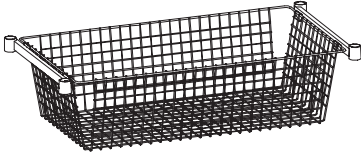
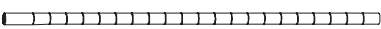
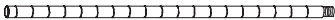
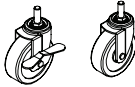

35.71 in L x 17.99 in W x 74.5 in H / 90.7 cm L x 45.7 cm W x 189.2 cm H

PARTS LIST

| PART/ILLUSTRATION | (QTY) | DESCRIPTION |
|--|--------|--|
| A  | (3) | shelf estante étagère |
| B  | (3) | drawers cajones tiroirs |
| C  | (4) | bottom upright inferior en posición vertical bas verticale |
| D  | (4) | top upright superior en posición vertical supérieure verticale |
| E  | (4) | casters ruedas roulettes |
| F  | (24) | shelf support clips clips de soporte de los estantes clips de support d'étagère |
| G  | | packaging embalaje conditionnement  |

ASSEMBLY

1

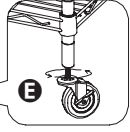
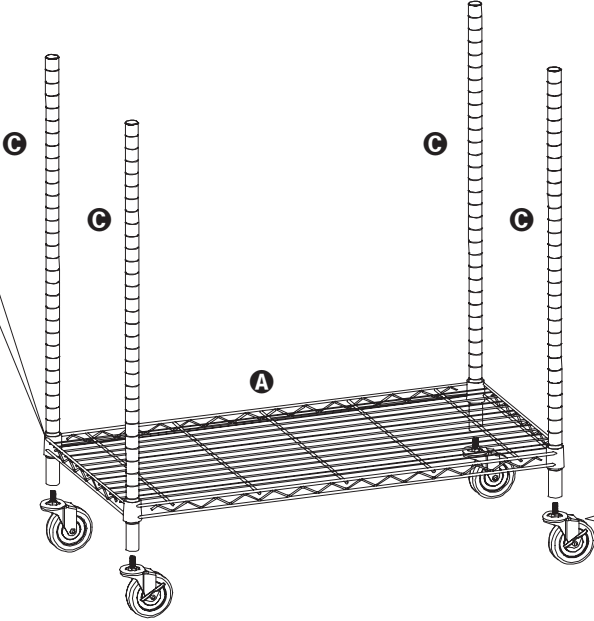
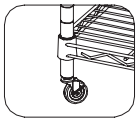
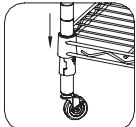
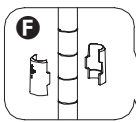
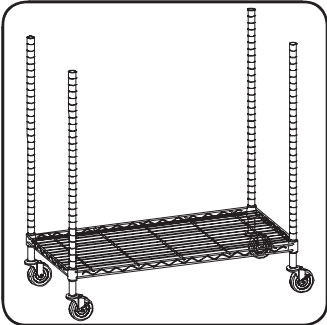

ASSEMBLY

2

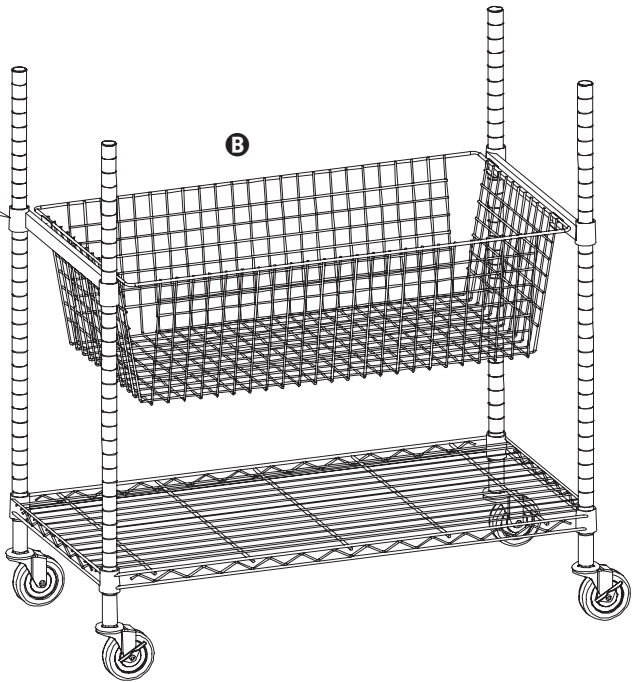
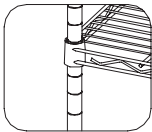
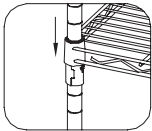
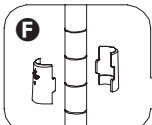

ASSEMBLY

3

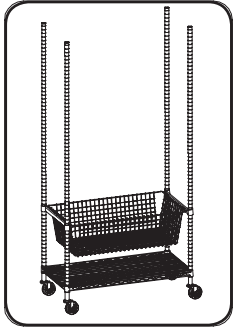
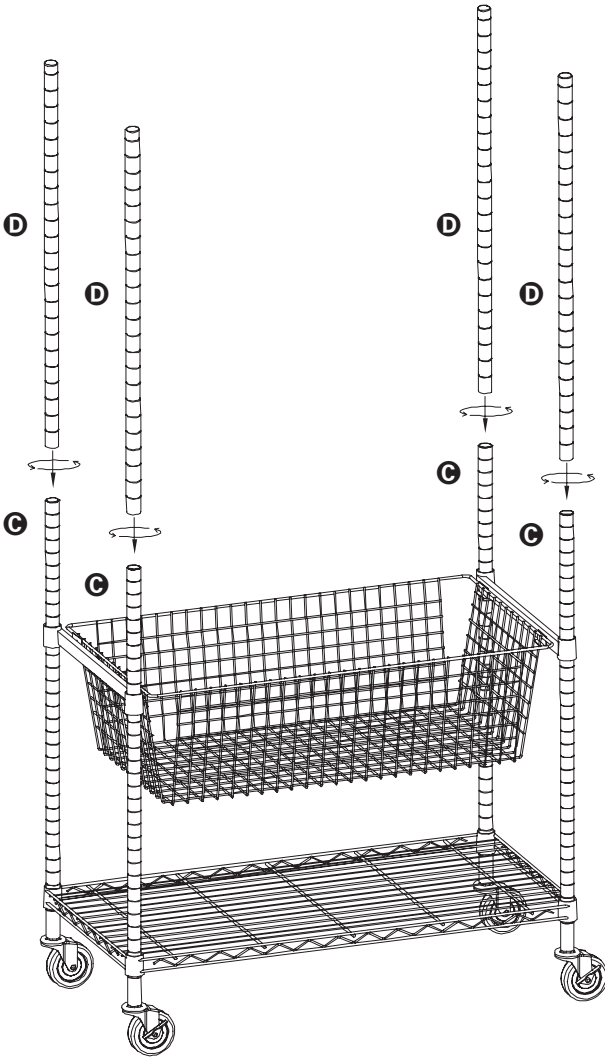

ASSEMBLY

4

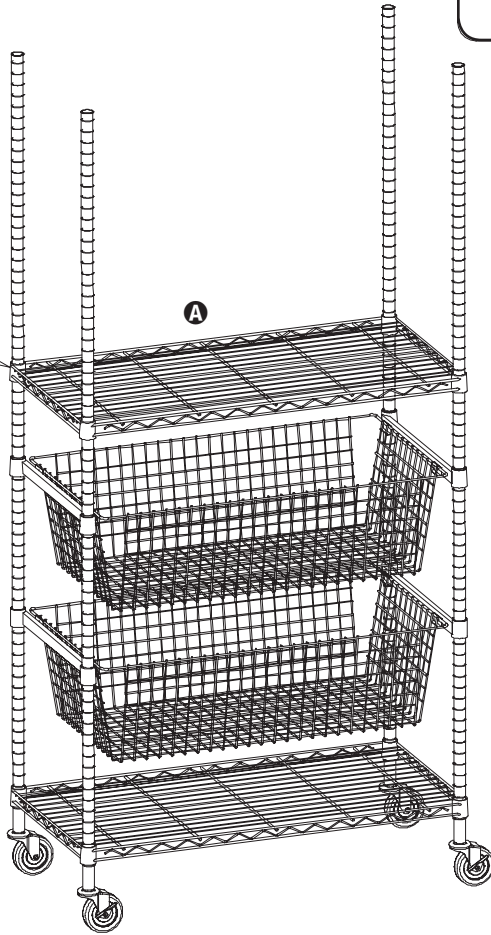
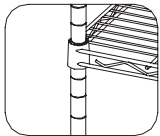
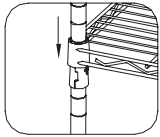
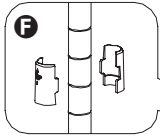
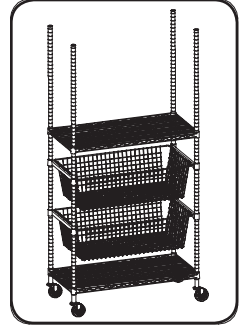

ASSEMBLY

5

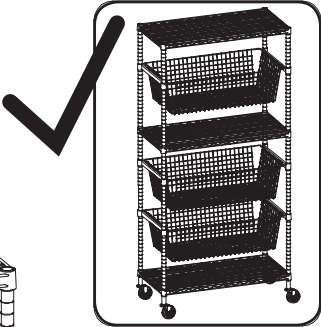
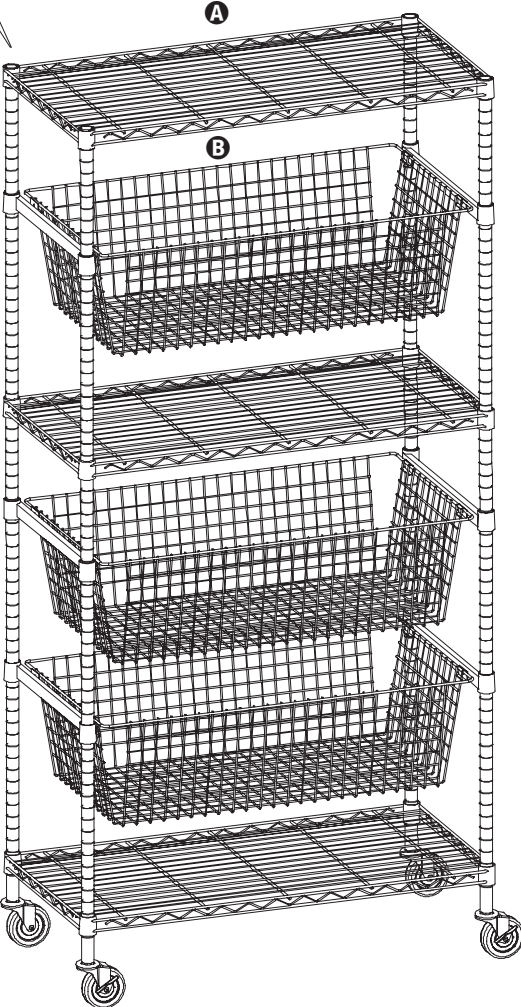
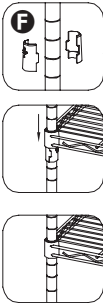

WARNING:
ADVERTENCIA:
AVERTISSEMENT:

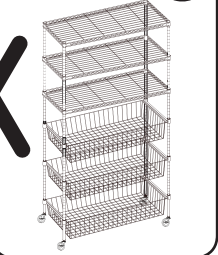

WARNING:
ADVERTENCIA:
AVERTISSEMENT:



LIMITED LIFETIME WARRANTY

Honey-Can-Do International, LLC (HCD) warrants its products will be free from defects in materials and workmanship when used for normal personal or household use. Except as provided below HCD, at its option, may offer a comparable product or offer a replacement part or request that the item be returned to the place of purchase. This warranty DOES NOT apply to damage caused by negligence, misuse, excessive use, improper cleaning, improper assembly, or any circumstances not directly attributable to manufacturing defects. Proof of purchase is required in the form of a receipt (copy or original) to validate warranty. HCD provides this limited lifetime warranty in lieu of all other warranties, either express or implied. In no event shall HCD, its affiliates, or subsidiaries be responsible for consequential or incidental damages arising out of a claim of defective product. Some states or provinces do not allow some exclusions or limitations, so the above statement may not apply to you. This warranty gives you specific legal rights. Additional rights vary by state or province.

WARNING:

Keep bags and plastic sheeting away from babies and children. Do not use in cribs, beds, carriages or playpens. The plastic may cling to the nose and mouth and prevent breathing.

GARANTÍA LIMITADA DE POR VIDA

Honey-Can-Do International, LLC (HCD) garantiza que sus productos estarán libres de defectos en los materiales y mano de obra cuando se utilice para su uso personal o doméstico normal. Salvo lo dispuesto a continuación HCD, a su discreción, puede ofrecer un producto similar u ofrecer una pieza de repuesto o solicitar que el artículo sea devuelto al lugar de compra. Esta garantía NO se aplica a los daños causados por negligencia, mal uso, uso excesivo, limpieza inadecuada, montaje incorrecto, o cualquier otra circunstancia no directamente atribuible a defectos de fabricación. Se requiere el comprobante de compra en la forma de un recibo (copia u original) para validar la garantía. HCD ofrece esta garantía limitada de por vida, en lugar de cualquier otra garantía, ya sea explícita o implícita. En ningún caso, HCD, sus afiliados o filiales serán responsables de daños directos o indirectos resultantes de una reclamación por producto defectuoso. Algunos estados o provincias no permiten algunas exclusiones o limitaciones, por lo que la afirmación anterior podría no ser aplicable a usted. Esta garantía le otorga derechos legales específicos. Derechos adicionales varían de acuerdo al estado o provincia.

ADVERTENCIA:

Mantenga las bolsas y láminas de plástico fuera del alcance de los niños y los bebés. No debe usarse en cunas, camas, carriolas o corrales de juego. El plástico puede adherirse a la nariz y boca y provocar asfisia.

GARANTIE À VIE LIMITÉE

Honey-Can-Do International, LLC (HCD) garantit que ses produits sont exempts de défauts de matériaux et de fabrication lorsqu'ils sont utilisés pour un usage personnel ou ménager standard. Sous réserve des dispositions ci-dessous, HCD, à sa discrétion, peut proposer un produit comparable ou offrir une pièce de rechange ou demander que l'article soit renvoyé à l'endroit de l'achat. La présente garantie ne s'applique pas aux dommages causés par négligence, abus, utilisation excessive, mauvais nettoyage, montage incorrect ou toute autre circonstance qui ne serait pas directement attribuables à des défauts de fabrication. Une preuve d'achat est nécessaire sous la forme d'un reçu (copie ou original) pour la validation de la garantie. La présente garantie à vie limitée fournie par HCD remplace toutes les autres garanties, qu'elles soient expressées ou implicites. En aucun cas, HCD, ses sociétés affiliées ou ses filiales ne peuvent être tenus responsables des dommages indirects ou accessoires issus d'une réclamation pour un produit défectueux. Certains états ou provinces ne permettant pas l'exclusion ni la restriction, la déclaration susmentionnée peut, en conséquence, ne pas vous concerner. La présente garantie vous confère des droits spécifiques. Les droits supplémentaires varient d'un état ou d'une province à l'autre.

AVERTISSEMENT:

Garder les sacs et les bâches en plastique à l'écart des bébés et des enfants. Ne pas utiliser dans des berceaux, des lits, des voitures ou des parcs de jeu. Le plastique peut s'accrocher au nez et à la bouche et empêcher la respiration.



YOUR SOURCE FOR
ORGANIZATION,
STORAGE & STYLE

Honey-Can-Do International

5300 St. Charles Road, Berkeley, IL 60163 USA

877.242.2636 | www.honeycando.com

©2017 Honey-Can-Do International, LLC | All Rights Reserved



Visit www.youtube.com/myhoneycando to watch our assembly videos.